

Part No. 060475-10, Rev A
September 2017

OmniSwitch AOS Release 6 Switch Management Guide

6.7.2 R02



www.al-enterprise.com

**This user guide documents release 6.7.2 R02 of the OmniSwitch 6350, 6450.
The functionality described in this guide is subject to change without notice.**

enterprise.alcatel-lucent.com Alcatel-Lucent and the Alcatel-Lucent Enterprise logo are trademarks of Alcatel-Lucent. To view other trademarks used by affiliated companies of ALE Holding, visit: enterprise.alcatel-lucent.com/trademarks. All other trademarks are the property of their respective owners. The information presented is subject to change without notice. Neither ALE Holding nor any of its affiliates assumes any responsibility for inaccuracies contained herein. (2017).



26801 West Agoura Road
Calabasas, CA 91301

Service & Support Contact Information

North America: 800-995-2696

Latin America: 877-919-9526

EMEA: +800 00200100 (Toll Free) or +1(650)385-2193

Asia Pacific: +65 6240 8484

Web: support.esd.alcatel-lucent.com

Email: ebg_global_supportcenter@al-enterprise.com

Contents

	About This Guide	xi
	Supported Platforms	xi
	Who Should Read this Manual?	xii
	When Should I Read this Manual?	xii
	What is in this Manual?	xii
	What is Not in this Manual?	xiii
	How is the Information Organized?	xiii
	Documentation Roadmap	xiv
	Related Documentation	xv
	Product Documentation	xvi
	Technical Support	xvi
Chapter 1	Managing System Files	1-1
	In This Chapter	1-1
	File Management Specifications	1-2
	Switch Administration Overview	1-3
	File Transfer	1-3
	Switch Directories	1-4
	File and Directory Management	1-5
	Using Wildcards	1-7
	Multiple Characters	1-7
	Single Characters	1-7
	Directory Commands	1-8
	Determining Your Location in the File Structure	1-8
	Changing Directories	1-9
	Displaying Directory Contents	1-10
	Making a New Directory	1-11
	Displaying Directory Contents Including Subdirectories	1-12
	Copying an Existing Directory	1-12
	Removing a Directory and its Contents	1-13
	File Commands	1-14
	Creating or Modifying Files	1-14
	Copy an Existing File	1-14
	Secure Copy an Existing File	1-15
	Move an Existing File or Directory	1-15
	Change File Attribute and Permissions	1-16
	Delete an Existing File	1-16
	Managing Files on Switches	1-17

Utility Commands	1-18
Displaying Free Memory Space	1-18
Performing a File System Check	1-18
Deleting the Entire File System	1-19
Process Self-test Function Commands	1-20
Loading Software onto the Switch	1-21
Using the Switch as an FTP Server	1-21
Using the Switch as an FTP Client	1-22
Using Secure Shell FTP	1-24
Closing a Secure Shell FTP Session	1-25
Using TFTP to Transfer Files	1-26
Using Zmodem	1-26
Registering Software Image Files	1-28
Directories on the Switch	1-28
Available Image Files	1-29
CodeGuardian	1-30
Application Examples for File Management	1-31
Transferring a File to the Switch Using FTP	1-31
Creating a File Directory on the Switch	1-32
FTP Client Application Example	1-33
Creating a File Directory Using Secure Shell FTP	1-35
Transfer a File Using Secure Shell FTP	1-36
Closing a Secure Shell FTP Session	1-36
Verifying Directory Contents	1-37
Installing Software Licenses	1-38
Licensed Features	1-39
Setting the System Clock	1-41
Setting Date and Time	1-41
Date	1-41
Time Zone	1-41
Time	1-42
Daylight Savings Time Configuration	1-43
Enabling DST	1-44

Chapter 2	Logging Into the Switch	2-1
	In This Chapter	2-1
	Login Specifications	2-3
	Login Defaults	2-3
	Quick Steps for Logging Into the Switch	2-5
	Overview of Switch Login Components	2-6
	Management Interfaces	2-6
	Logging Into the CLI	2-6
	Using the WebView Management Tool	2-7
	Using SNMP to Manage the Switch	2-7
	User Accounts	2-7

Using Telnet	2-8
Logging Into the Switch Through Telnet	2-8
Starting a Telnet Session from the Switch	2-8
Using FTP	2-10
Using FTP to Log Into the Switch	2-10
Using Secure Shell	2-12
Secure Shell Components	2-12
Secure Shell Interface	2-13
Configuring the SSH TCP port number	2-13
Secure Shell File Transfer Protocol	2-13
Secure Shell Application Overview	2-14
Secure Shell Authentication	2-15
Protocol Identification	2-15
Algorithm and Key Exchange	2-15
Authentication Phase	2-16
Connection Phase	2-17
Using Secure Shell DSA Public Key Authentication	2-17
Starting a Secure Shell Session	2-18
Closing a Secure Shell Session	2-20
Log Into the Switch with Secure Shell FTP	2-20
Closing a Secure Shell FTP Session	2-21
Modifying the Login Banner	2-22
Modifying the Text Display Before Login	2-23
Configuring Login Parameters	2-24
Configuring the Inactivity Timer	2-24
Enabling the DNS Resolver	2-25
Verifying Login Settings	2-26
Chapter 3 Using SNMP and OpenFlow	3-1
In This Chapter	3-1
SNMP Specifications	3-2
SNMP Defaults	3-3
Quick Steps for Setting Up An SNMP Management Station	3-4
Quick Steps for Setting Up Trap Filters	3-5
Filtering by Trap Families	3-5
Filtering by Individual Traps	3-6
SNMP Overview	3-7
SNMP Operations	3-7
Using SNMP for Switch Management	3-8
Setting Up an SNMP Management Station	3-8
SNMP Versions	3-8
SNMPv1	3-8
SNMPv2	3-9
SNMPv3	3-9

Using SNMP For Switch Security	3-10
Community Strings (SNMPv1 and SNMPv2)	3-10
Configuring Community Strings	3-10
Encryption and Authentication (SNMPv3)	3-11
Configuring Encryption and Authentication	3-11
Setting SNMP Security	3-13
Working with SNMP Traps	3-14
Trap Filtering	3-14
Filtering by Trap Families	3-14
Filtering By Individual Trap	3-14
Authentication Trap	3-15
Trap Management	3-15
Replaying Traps	3-15
Absorbing Traps	3-15
Sending Traps to WebView	3-15
Checking Configuration File Using Traps	3-16
SNMP MIB Information	3-17
MIB Tables	3-17
MIB Table Description	3-17
Industry Standard MIBs	3-18
Enterprise (Proprietary) MIBs	3-22
Verifying the SNMP Configuration	3-26
OpenFlow Specifications	3-27
OpenFlow Agent Overview	3-28
OpenFlow Logical Switch	3-28
OpenFlow Normal Mode	3-28
OpenFlow Hybrid (API) Mode	3-28
Supported OpenFlow Parameters	3-28
Quick Steps to Configure OpenFlow Agent	3-30
Verifying OpenFlow Configuration	3-31
Chapter 4 Configuring Network Time Protocol (NTP)	4-1
In This Chapter	4-1
NTP Specifications	4-2
NTP Defaults Table	4-2
NTP Quick Steps	4-3
NTP Overview	4-5
Stratum	4-6
Using NTP in a Network	4-6
Authentication	4-8
Configuring NTP	4-9
Configuring the OmniSwitch as a Client	4-9
NTP Servers	4-10
Using Authentication	4-12
Verifying NTP Configuration	4-13

Chapter 5	Managing CMM Directory Content	5-1
	In This Chapter	5-1
	CMM Specifications	5-2
	USB Flash Drive Specifications	5-2
	CMM Files	5-3
	CMM Software Directory Structure	5-3
	Where is the Switch Running From?	5-4
	Software Rollback Feature	5-4
	Software Rollback Configuration Scenarios for a Single Switch	5-5
	Redundancy	5-9
	Redundancy Scenarios	5-9
	Managing the Directory Structure	
	(Non-Redundant)	5-13
	Rebooting the Switch	5-13
	Copying the Running Configuration to the Working Directory	5-16
	Rebooting from the Working Directory	5-18
	Copying the Working Directory to the Certified Directory	5-21
	Copying the Certified Directory to the Working Directory	5-22
	Show Currently Used Configuration	5-23
	Show Switch Files	5-24
	Managing Redundancy in a Stack and CMM	5-25
	Rebooting the Switch	5-25
	Copying the Working Directory to the Certified Directory	5-26
	Synchronizing the Primary and Secondary CMMs	5-27
	Swapping the Primary CMM for the Secondary CMM	5-29
	Show Currently Used Configuration	5-30
	NI Module Behavior During Takeover	5-31
	Using the USB Flash Drive	5-32
	Transferring Files Using USB	5-32
	Automatically Upgrading Code Using USB	5-32
	Disaster Recovery Using USB	5-33
	Emergency Restore of the boot.cfg File	5-34
	Can I Restore the boot.file While Running from Certified?	5-34
	Checking the Integrity of the Image	5-35
	Displaying CMM Conditions	5-36
Chapter 6	Using the CLI	6-1
	CLI Specifications	6-2
	CLI Overview	6-3
	Online Configuration	6-3
	Offline Configuration Using Configuration Files	6-3
	Command Entry Rules and Syntax	6-4
	Text Conventions	6-4
	Using “Show” Commands	6-5
	Using the “No” Form	6-5

Using “Alias” Commands	6-5
Partial Keyword Completion	6-6
CLI Auto Completion	6-6
Command Help	6-7
Tutorial for Building a Command Using Help	6-9
CLI Services	6-11
Command Line Editing	6-11
Deleting Characters	6-11
Recalling the Previous Command Line	6-12
Inserting Characters	6-12
Syntax Checking	6-13
Prefix Recognition	6-13
Example for Using Prefix Recognition	6-14
Prefix Prompt	6-15
Command History	6-15
Logging CLI Commands and Entry Results	6-17
Enabling Command Logging	6-17
Disabling Command Logging	6-17
Viewing the Current Command Logging Status	6-18
Viewing Logged CLI Commands and Command Entry Results	6-18
Customizing the Screen Display	6-19
Changing the Screen Size	6-19
Changing the CLI Prompt	6-19
Setting Session Prompt as System Name	6-20
Displaying Table Information	6-20
Filtering Table Information	6-21
Multiple User Sessions	6-22
Listing Other User Sessions	6-22
Listing Your Current Login Session	6-23
Terminating Another Session	6-24
Application Example	6-25
Using a Wildcard to Filter Table Information	6-25
Verifying CLI Usage	6-27

Chapter 7	Working With Configuration Files	7-1
	In This Chapter	7-1
	Configuration File Specifications	7-2
	Tutorial for Creating a Configuration File	7-2
	Quick Steps for Applying Configuration Files	7-4
	Setting a File for Immediate Application	7-4
	Setting an Application Session for a Date and Time	7-4
	Setting an Application Session for a Specified Time Period	7-5
	Configuration Files Overview	7-6
	Applying Configuration Files to the Switch	7-6
	Verifying a Timed Session	7-6
	Canceling a Timed Session	7-7

Configuration File Error Reporting	7-7
Setting the Error File Limit	7-8
Syntax Checking	7-8
Displaying a Text File	7-9
Text Editing on the Switch	7-9
Invoke the “Vi” Editor	7-9
Creating Snapshot Configuration Files	7-10
Snapshot Feature List	7-10
User-Defined Naming Options	7-11
Editing Snapshot Files	7-11
Verifying File Configuration	7-14

Chapter 8 Managing Automatic Remote Configuration Download 8-1

In This Chapter	8-1
Automatic Remote Configuration Specifications	8-2
Automatic Remote Configuration Defaults	8-3
Quick Steps for Automatic Remote Configuration	8-4
Overview	8-5
Basic Operation	8-5
Network Components	8-6
Information Provided by DHCP Server	8-6
Information Provided by Instruction File	8-6
File Servers and Download Process	8-7
LED Status	8-7
Interaction With Other Features	8-8
UDP/DHCP Relay	8-8
QoS	8-8
802.1Q	8-8
LLDP	8-8
Dynamic Link Aggregation (LACP)	8-8
Automatic Remote Configuration Download Process	8-9
Process Illustration	8-10
Additional Process Notes	8-11
Download Component Files	8-12
Instruction File	8-12
Instruction File Syntax	8-13
Instruction File Usage Guidelines	8-14
Firmware Upgrade Files	8-14
Bootup Configuration File	8-14
Bootup Configuration File Usage Guidelines	8-14
Debug Configuration File	8-15
Script File	8-15
Script File Usage Guidelines	8-15
LACP Auto Detection and Automatic Link Aggregate Association	8-16
DHCP Client Auto-Configuration Process	8-17

	DHCP Server Preference	8-18
	Nearest-Edge Mode Operation	8-20
	Zero Touch License Upgrade	8-22
	Troubleshooting	8-23
	Error Resolution	8-23
	Server Connection Failure and File Download Errors	8-23
	Error Description Table	8-24
	Script File Errors	8-24
	Error Description Table	8-25
Chapter 9	Managing Switch User Accounts	9-1
	In This Chapter	9-1
	User Database Specifications	9-2
	User Account Defaults	9-2
	Overview of User Accounts	9-4
	Startup Defaults	9-6
	Quick Steps for Network Administrator User Accounts	9-7
	Quick Steps for Creating Customer Login User Accounts	9-8
	Default User Settings	9-9
	Account and Password Policy Settings	9-10
	How User Settings Are Saved	9-11
	Creating a User	9-12
	Removing a User	9-12
	User-Configured Password	9-13
	Configuring Password Policy Settings	9-14
	Setting a Minimum Password Size	9-15
	Configuring the Username Password Exception	9-15
	Configuring Password Character Requirements	9-15
	Configuring Password Expiration	9-16
	Default Password Expiration	9-16
	Specific User Password Expiration	9-16
	Configuring the Password History	9-17
	Configuring the Minimum Age for a Password	9-17
	Configuring Global User Lockout Settings	9-18
	Configuring the User Lockout Window	9-18
	Configuring the User Lockout Threshold Number	9-19
	Configuring the User Lockout Duration Time	9-19
	Manually Locking and Unlocking User Accounts	9-20
	Configuring Privileges for a User	9-21
	Setting Up SNMP Access for a User Account	9-22
	SNMP Access Without Authentication/Encryption	9-24
	SNMP Access With Authentication/Encryption	9-24
	Removing SNMP Access From a User	9-24
	Setting Up End-User Profiles	9-25
	Creating End-User Profiles	9-26

	Setting Up Port Ranges in a Profile	9-26
	Setting Up VLAN Ranges in a Profile	9-26
	Associating a Profile With a User	9-27
	Removing a Profile From the Configuration	9-27
	Verifying the User Configuration	9-27
Chapter 10	Managing Switch Security	10-1
	In This Chapter	10-1
	Switch Security Specifications	10-2
	Switch Security Defaults	10-2
	Switch Security Overview	10-3
	Authenticated Switch Access	10-4
	AAA Servers—RADIUS or LDAP	10-4
	Authentication-only—ACE/Server	10-4
	Interaction With the User Database	10-5
	ASA and Authenticated VLANs	10-5
	Configuring Authenticated Switch Access	10-6
	Quick Steps for Setting Up ASA	10-7
	Setting Up Management Interfaces for ASA	10-9
	Enabling Switch Access	10-10
	Configuring the Default Setting	10-10
	Using Secure Shell	10-11
	Configuring Accounting for ASA	10-12
	Enabling or Disabling Console Session	10-13
	Authenticated Switch Access - Enhanced Mode	10-14
	Configuring the ASA Mode	10-14
	Configuring the IP Lockout Threshold Value	10-16
	Unlock/Release Banned or Locked IP	10-16
	Configuring Privileges for an Access Type	10-17
	Configuring Management Station	10-18
	Verifying the ASA Configuration	10-19
Chapter 11	Using WebView	11-1
	In This Chapter	11-1
	WebView CLI Defaults	11-2
	Browser Setup	11-2
	WebView CLI Commands	11-3
	Enabling/Disabling WebView	11-3
	Changing the HTTP Port	11-3
	Enabling/Disabling SSL	11-4
	Changing the HTTPS Port	11-4
	Quick Steps for Setting Up WebView	11-5

WebView Overview	11-5
WebView Page Layout	11-5
Banner	11-6
Toolbar	11-6
Feature Options	11-7
View/Configuration Area	11-7
Configuring the Switch With WebView	11-8
Accessing WebView	11-8
Accessing WebView with Internet Explorer Version 7	11-9
Home Page	11-10
Configuration Page	11-12
Global Configuration Page	11-12
Table Configuration Page	11-13
Table Features	11-17
Adjacencies	11-23
OAW-AP Web Management Configuration	11-24
Configuring the Virtual Cluster IP address for OAW-AP	
Web Management using CLI	11-24
Automatic Configuration of Cluster Virtual IP Address	11-24
Enabling Automatic Configuration of Cluster Virtual IP Address	11-25
Configuring the Virtual Cluster IP address for OAW-AP	
Web management using WebView	11-26
Verifying the WLAN Configuration	11-26
Accessing the WLAN Management page from WebView	11-27
WebView Help	11-28
General WebView Help	11-28
Specific-page Help	11-28

Appendix A	Software License and Copyright Statements	A-1
	Alcatel-Lucent License Agreement	A-1
	ALE USA, Inc. SOFTWARE LICENSE AGREEMENT	A-1
	Third Party Licenses and Notices	A-4
	A. Booting and Debugging Non-Proprietary Software	A-4
	B. The OpenLDAP Public License: Version 2.8, 17 August 2003	A-4
	C. Linux	A-5
	D. GNU GENERAL PUBLIC LICENSE: Version 2, June 1991	A-5
	E. University of California	A-10
	F. Carnegie-Mellon University	A-10
	G. Random.c	A-10
	H. Appetite, Inc.	A-11
	I. Agranat	A-11
	J. RSA Security Inc.	A-11
	K. Sun Microsystems, Inc.	A-12
	L. Wind River Systems, Inc.	A-12
	M. Network Time Protocol Version 4	A-12
	N. Remote-ni	A-13
	O. GNU Zip	A-13
	P. FREESCALE SEMICONDUCTOR SOFTWARE LICENSE AGREEMENT	A-13
	Q. Boost C++ Libraries	A-14
	R. U-Boot	A-14

S. Solaris	A-14
T. Internet Protocol Version 6	A-14
U. CURSES	A-15
V. ZModem	A-15
W. Boost Software License	A-15
X. OpenLDAP	A-15
Y. BITMAP.C	A-16
Z. University of Toronto	A-16
AA.Free/OpenBSD	A-16
Appendix B	
SNMP Trap Information	B-1
SNMP Traps Table	B-2
Index	Index-1

About This Guide

This *OmniSwitch 6350, 6450* describes basic attributes of your switch and basic switch administration tasks. The software features described in this manual are shipped standard with your OmniSwitch 6350, 6450 switches. These features are used when readying a switch for integration into a live network environment.

Supported Platforms

This information in this guide applies to the following product:

- OmniSwitch 6350 Series
- OmniSwitch 6450 Series

Unsupported Platforms

The information in this guide does not apply to the following products:

- OmniSwitch 6250 Series
- OmniSwitch 9000 Series
- OmniSwitch 6400 Series
- OmniSwitch 6600 Family
- OmniSwitch 6800 Family
- OmniSwitch 6850 Series
- OmniSwitch 6855 Series
- OmniSwitch (original version with no numeric model name)
- OmniSwitch 7700/7800
- OmniSwitch 8800
- Omni Switch/Router
- OmniStack
- OmniAccess

Who Should Read this Manual?

The audience for this user guide are network administrators and IT support personnel who need to configure, maintain, and monitor switches and routers in a live network. However, anyone wishing to gain knowledge on how fundamental software features are implemented in the OmniSwitch 6350, 6450 switches benefits from the material in this configuration guide.

When Should I Read this Manual?

Read this guide as soon as your switch is up and running and you are ready to familiarize yourself with basic software functions.

You should have already set up a switch password and be familiar with the very basics of the switch software. This manual helps you understand the directory structure, the Command Line Interface (CLI), configuration files, basic security features, and basic administrative functions of the switch. The features and procedures in this guide will help form a foundation that will allow you to configure more advanced switching features later.

What is in this Manual?

This configuration guide includes information about the following features:

- Basic switch administrative features, such as file editing utilities, procedures for loading new software, and setting up system information (name of switch, date, time).
- Configurations files, including snapshots, off-line configuration, time-activated file download.
- The CLI, including on-line configuration, command-building help, syntax error checking, and line editing.
- Basic security features, such as switch access control and customized user accounts.
- SNMP
- Web-based management (WebView)

What is Not in this Manual?

The configuration procedures in this manual primarily use Command Line Interface (CLI) commands in examples. CLI commands are text-based commands used to manage the switch through serial (console port) connections or through Telnet sessions. This guide does include introductory chapters for alternative methods of managing the switch, such as web-based (WebView) and SNMP management. However the primary focus of this guide is managing the switch through the CLI.

Further information on WebView can be found in the context-sensitive on-line help available with that application.

This guide does not include documentation for the OmniVista network management system. However, OmniVista includes a complete context-sensitive on-line help system.

This guide provides overview material on software features, how-to procedures, and tutorials that will enable you to begin configuring your OmniSwitch. However, it is not intended as a comprehensive reference to all CLI commands available in the OmniSwitch. For such a reference to all CLI commands, consult the *OmniSwitch AOS Release 6 CLI Reference Guide*.

How is the Information Organized?

Each chapter in this guide includes sections that will satisfy the information requirements of casual readers, rushed readers, serious detail-oriented readers, advanced users, and beginning users.

Quick Information. Most chapters include a *specifications table* that lists RFCs and IEEE specifications supported by the software feature. In addition, this table includes other pertinent information such as minimum and maximum values and sub-feature support. Some chapters include a *defaults table* that lists the default values for important parameters along with the CLI command used to configure the parameter. Many chapters include *Quick Steps* sections, which are procedures covering the basic steps required to get a software feature up and running.

In-Depth Information. All chapters include *overview sections* on software features as well as on selected topics of that software feature. *Topical sections* may often lead into *procedure sections* that describe how to configure the feature just described. Many chapters include *tutorials* or *application examples* that help convey how CLI commands can be used together to set up a particular feature.

Documentation Roadmap

The OmniSwitch user documentation suite was designed to supply you with information at several critical junctures of the configuration process. The following section outlines a roadmap of the manuals that will help you at each stage of the configuration process. Under each stage, we point you to the manual or manuals that will be most helpful to you.

Stage 1: Gaining Familiarity with Basic Switch Functions

Pertinent Documentation: *Hardware Users Guide*
Switch Management Guide

Once you have your switch up and running, you will want to begin investigating basic aspects of its hardware and software. Information about switch hardware is provided in the *Hardware Guide*. This guide provides specifications, illustrations, and descriptions of all hardware components, such as chassis, power supplies, Chassis Management Modules (CMMs), Network Interface (NI) modules, and cooling fans. It also includes steps for common procedures, such as removing and installing switch components.

The *Switch Management Guide* is the primary users guide for the basic software features on a single switch. This guide contains information on the switch directory structure, basic file and directory utilities, switch access security, SNMP, and web-based management. It is recommended that you read this guide before connecting your switch to the network.

Stage 2: Integrating the Switch Into a Network

Pertinent Documentation: *Network Configuration Guide*

When you are ready to connect your switch to the network, you need to learn how the OmniSwitch implements fundamental software features, such as 802.1Q, VLANs, Spanning Tree, and network routing protocols. The *Network Configuration Guide* contains overview information, procedures, and examples on how standard networking technologies are configured in the OmniSwitch.

Anytime

The *CLI Reference Guide* contains comprehensive information on all CLI commands supported by the switch. This guide includes syntax, default, usage, example, related CLI command, and CLI-to-MIB variable mapping information for all CLI commands supported by the switch. This guide can be consulted anytime during the configuration process to find detailed and specific information on each CLI command.

Related Documentation

User manuals can be downloaded at following

<https://support.esd.alcatel-lucent.com>

The following are the titles and descriptions of all the related OmniSwitch 6350, 6450 user manuals:

- *OmniSwitch 6350 Hardware Users Guide*

Complete technical specifications and procedures for all OmniSwitch 6350 chassis, power supplies, and fans. Also includes comprehensive information on assembling and managing stacked configurations.

- *OmniSwitch 6450 Hardware Users Guide*

Complete technical specifications and procedures for all OmniSwitch 6450 chassis, power supplies, and fans. Also includes comprehensive information on assembling and managing stacked configurations.

- *OmniSwitch AOS Release 6 CLI Reference Guide*

Complete reference to all CLI commands supported on the OmniSwitch 6350, 6450. Includes syntax definitions, default values, examples, usage guidelines and CLI-to-MIB variable mappings.

- *OmniSwitch AOS Release 6 Switch Management Guide*

Includes procedures for readying an individual switch for integration into a network. Topics include the software directory architecture, image rollback protections, authenticated switch access, managing switch files, system configuration, using SNMP, and using web management software (WebView).

- *OmniSwitch AOS Release 6 Network Configuration Guide*

Includes network configuration procedures and descriptive information on all the major software features and protocols included in the base software package. Chapters cover Layer 2 information (Ethernet and VLAN configuration), Layer 3 information (routing protocols, such as RIP), security options (authenticated VLANs), Quality of Service (QoS), and link aggregation.

- *OmniSwitch AOS Release 6 Transceivers Guide*

Includes information on Small Form Factor Pluggable (SFPs) and 10 Gbps Small Form Factor Pluggables (XFPs) transceivers.

- *AOS Release 6.7.2 Release Notes*

Includes critical Open Problem Reports, feature exceptions, and other important information on the features supported in the current release and any limitations to their support.

- *Technical Tips, Field Notices*

Includes information published by Alcatel-Lucent's Customer Support group.

Product Documentation

All products are shipped with a Product Documentation Card that provides details for downloading documentation for all OmniSwitch and other Alcatel-Lucent Enterprise data products. All user guides for the OmniSwitch Series are included on the Alcatel-Lucent Enterprise public website. This website also includes user guides for other Alcatel-Lucent Enterprise products. The latest user guides can be found on our website at:

<https://support.esd.alcatel-lucent.com>

Technical Support

An Alcatel-Lucent Enterprise service agreement brings your company the assurance of 7x24 no-excuses technical support. You will also receive regular software updates to maintain and maximize your Alcatel-Lucent product's features and functionality and on-site hardware replacement through our global network of highly qualified service delivery partners. Additionally, with 24-hour-a-day access to Alcatel-Lucent's Service and Support web page, you'll be able to view and update any case (open or closed) that you have reported to Alcatel-Lucent's technical support, open a new case or access helpful release notes, technical bulletins, and manuals.

For more information on Alcatel-Lucent Enterprise Service Programs:

Web: <https://support.esd.alcatel-lucent.com>

Email: ebg_global_supportcenter@al-enterprise.com.

Phone:

North America: 800-995-2696

Latin America: 877-919-9526

EMEA: +800 00200100 (Toll Free) or +1(650) 385-2193

Asia Pacific: +65 6240 8484

1 Managing System Files

This chapter describes the several methods of transferring software files onto the OmniSwitch and how to register those files for use by the switch. This chapter also describes several basic switch management procedures and discusses the Command Line Interface (CLI) commands used.

- File Management (copy, secure copy, edit, rename, remove, change, and display file attributes)
- Directory Management (create, copy, move, remove, rename, and display directory information)
- System Date and Time (set system clock)

CLI commands are used in the configuration examples; for more details about the syntax of commands, see the *OmniSwitch AOS Release 6 CLI Reference Guide*.

In This Chapter

Configuration procedures described in this chapter include:

- [“Loading Software onto the Switch” on page 1-21](#)
- [“Creating a File Directory on the Switch” on page 1-32](#)
- [“Registering Software Image Files” on page 1-28](#)
- [“Installing Software Licenses” on page 1-38](#)
- [“Setting the System Clock” on page 1-41](#)

For related information about connecting a terminal to the switch, see [“Getting Started”](#) chapter in your *OmniSwitch AOS Release 6350/6450 Hardware Users Guide*. For information about switch command privileges, see [Chapter 10, “Managing Switch Security.”](#)

File Management Specifications

The functionality described in this chapter is supported unless otherwise stated in the following Specifications table or specifically noted within any section of this chapter.

File Transfer Methods	FTP, TFTP, SFTP, Zmodem.
Switch Software Utility	OmniSwitch as an FTP Client, FTP server or TFTP Client.
Configuration Recovery	The flash/certified directory holds configurations that are certified as the default start-up files for the switch. They will be used in the event of a non-specified reload.
Switch /flash Directory	<ul style="list-style-type: none"> • 128 MB flash memory available for switch files and directories • Contains the /certified and /working directories.
File/Directory Name Metrics	<ul style="list-style-type: none"> • 32 characters maximum for directory and file names • 255 character maximum for a fully qualified path
File/Directory Name Characters	Character types are limited to a-z, A-Z, 0-9, dashes (-), dots (.), and underlines (_).
Maximum Number of Files/Directories	Maximum of 244 files and/or directories allowed in the root (flash) directory.
Sub-Directories	Up to seven sub-directories allowed including /flash .
Text Editing	Vi standard UNIX editor. The Ed standard UNIX editor is available in the debug mode.
System Clock	Set local date, time and time zone, Universal Time Coordinate (UTC), Daylight Savings (DST or summertime).
System Date Default Value	THU JAN 01 1970 (Thursday, January 1, 1970)

Switch Administration Overview

The OmniSwitch has a variety of software features designed for different networking environments and applications. Over the life of the switch, it is very likely that your configuration and feature set will change because the needs of your network are likely to expand. Also, software updates become available from Alcatel-Lucent. If you change your configuration to upgrade your network, you must understand how to install switch files and to manage switch directories.

You can use this memory to store files, including executable files (used to operate switch features and applications), configuration files, and log files.

You need to understand the various methods of loading files onto the switch for software upgrades and new features. Once the files are on the switch, the CLI has commands that allow you to load, copy, and delete these files. The CLI also has commands for displaying, creating, and editing ASCII files directly on the switch. You may also want to establish a file directory structure to help organize your files on the switch.

All the files and directories on the switch bear a time stamp. This is useful for switch administration because the time stamp allows you to tell at a glance which files are the most recent. You can set the system clock that controls these time stamps as well as other time based switch functions.

File Transfer

The switch can receive and send files by using industry standard local and remote transfer methods. Each of these methods is defined and explained. Because file transfers can involve logging onto the switch from a remote host, security factors, such as DNS resolver and Authenticated Switch Access requirements should be considered.

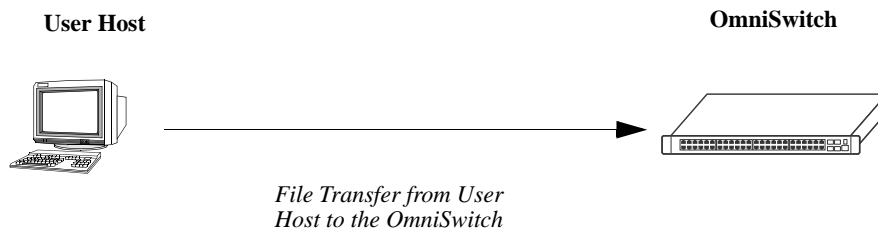

File Transfer to OmniSwitch

It is not enough to simply transfer a file onto the switch. Once files are on the switch, they must be registered in order to become functional. The OmniSwitch has a directory structure that allows you to install new software while maintaining a backup copy of your old configuration. This directory structure is explained in the [“Switch Directories” section on page 1-4](#).

Switch Directories

You can create your own directories in the switch flash directory. This allows you to organize your configuration and text files on the switch. You can also use the `vi` command to create files. This chapter tells you how to make, copy, move, and delete both files and directories.

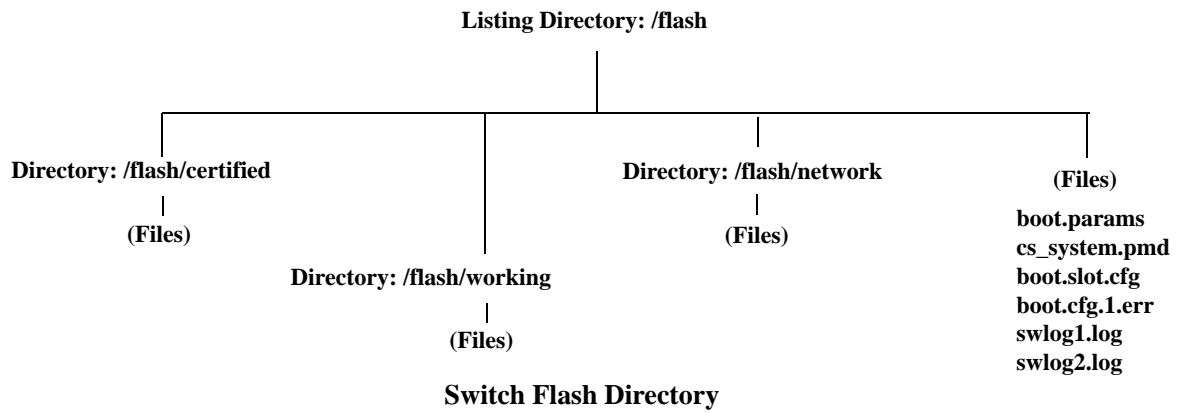

File and Directory Management

A number of CLI commands allow you to manage files on your switch by grouping them into sub-directories within the switch flash directory. These commands perform the same functions as file management software applications (such as Microsoft Explorer) perform on a workstation. For documentation purposes, we have categorized the commands into the following three groups.

- **Directory** commands allow you to create, copy, move, remove, rename, and display directories.
- **File** commands allow you copy, secure copy, edit, rename, remove, change, and display file attributes.
- **Utility** commands display memory and system diagnostic information.

The following illustration represents a *sample* flash directory that contains three directories and six files at the top level. The sample working directory and the certified directory both hold five files. The sample network directory holds one file. This sample flash directory is used in the explanations of the directory, file and utility CLI commands described in the following section. The switch may show files and directories different from the ones shown in this.

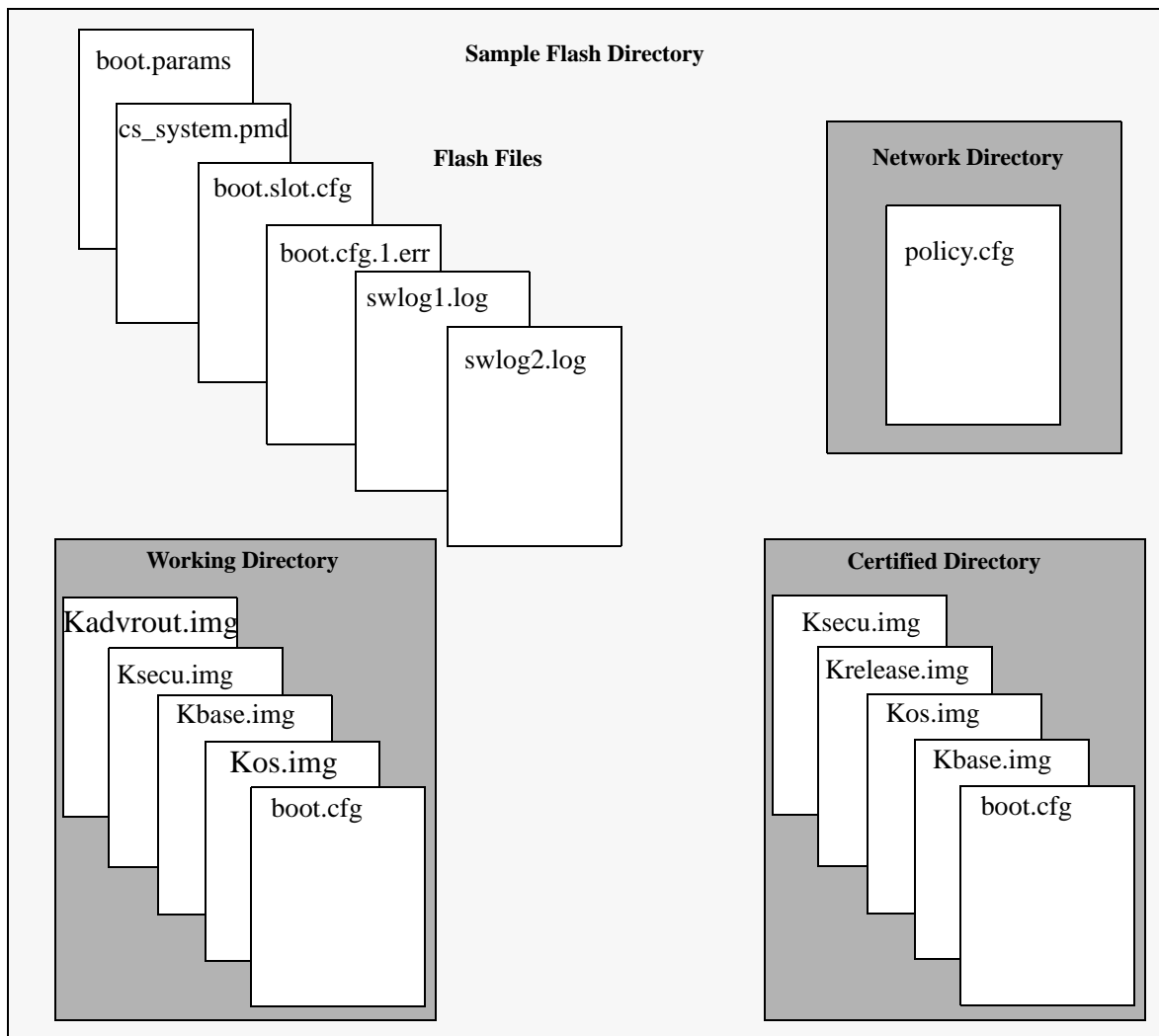

To list all the files and directories in your current directory, use the **ls** command. Here is a sample display of the flash directory.

```
-> ls

Listing Directory /flash:

-rw      315 Jan  5 09:38 boot.params
drw     2048 Jan  5 09:22 certified/
drw     2048 Jan  5 09:22 working/
-rw       12 Dec 18  2030 boot.slot.cfg
drw     2048 Dec 27  2030 switch/
-rw    64000 Jan  5 09:37 swlog1.log
-rw    64000 Dec 27  2030 swlog2.log
-rw       256 Dec 27  2030 random-seed
drw     2048 Dec 18  2030 network/

40208384 bytes free
```

The following information describes the screen displayed by the **ls** command:

- The first column consists of three text characters. The first character indicates whether the row entry is a file (-) or a directory (d). The second and third characters indicate the user read/write permissions.

```
drw      512 Oct 25 14:17 WORKING/
-rw      321 Oct 25 14:39 boot.params
```

Here, the first entry shows a directory (d) for which the user has read and write (rw) permissions. The second entry shows a file (-) for which the user has read and write (rw) permissions.

- The second column indicates the number of bytes of flash memory the row entry occupies.

```
drw      512 Oct 25 14:17 WORKING/
-rw      321 Oct 25 14:39 boot.params
```

Here, the first entry shows that the directory uses 512 bytes of flash memory. The second entry shows that the file occupies 321 bytes of flash memory.

- The third, fourth and fifth columns show the date and time the row entry was created or copied into the flash directory.

```
drw      512 Oct 25 14:17 WORKING/
-rw      321 Oct 25 14:39 boot.params
```

Here, the first entry indicates the file was created or copied on April 22 at 05:23 hours. The second entry indicates that the directory was created or copied on April 19 at 06:12 hours.

- The column on the right lists the file or directory name. Note that directory names end with a slash (/) character.

```
drw      512 Oct 25 14:17 WORKING/
-rw      321 Oct 25 14:39 boot.params
```

Here, the first entry shows a directory named WORKING, the second entry shows a file named boot.params.

- The value shown at the bottom of the display indicates the amount of flash memory remaining for use in this directory (9.47 megabytes in the above example).

Using Wildcards

Wildcards allow you to substitute symbols (* or ?) for text patterns while using file and directory commands. The asterisk (*) takes the place of multiple characters and the question mark character (?) takes the place of single characters. More than one wildcard can be used within a single text string.

Multiple Characters

An asterisk (*) is used as a wildcard for multiple characters in a text pattern. The following command will list all entries in the current directory that end with the **.log** extension:

```
-> ls *.log

Listing Directory /flash:

-rw      64000 Sep 21 19:49 swlog1.log
-rw      64000 Aug 12 19:06 swlog2.log
```

The following command lists all entries in the current directory that contain the **i** character.

```
-> ls *i*

Listing Directory /flash:

drw      2048 Aug 21 17:49 certified/
drw      2048 Aug 12 18:51 working/
-rw          31 Jul 29 2001 policy.cfg
drw      2048 Jul 28 12:17 switch/
```

Single Characters

The question mark (?) is used as a wildcard for a single character in a text pattern. The following command will locate all entries containing **swlog** followed by *any single character* and the **.log** extension.

```
-> ls swlog?.log

Listing Directory /flash:

-rw      64000 Jul 21 19:49 swlog1.log
-rw      64000 Aug 12 19:06 swlog2.log
```

The single and multiple character wildcards can be used in combination. The following command lists all entries containing the letter **i** followed by any two single characters.

```
-> ls *i??

Listing Directory /flash:

drw      2048 Aug 12 18:51 working/
```

Directory Commands

The directory commands are applied to the switch file system and to files contained within the file system. When you first enter the flash directory, your login is located at the top of the directory tree. You may navigate within this directory by using the **pwd** and **cd** commands (discussed below). The location of your login within the directory structure is called your *current directory*. You need to observe your login location because when you issue a command, that command applies only to directories and files in your current directory unless another path is specified.

The following drawing is a logical representation of the OmniSwitch file directory shown in the illustration on [page 1-5](#).

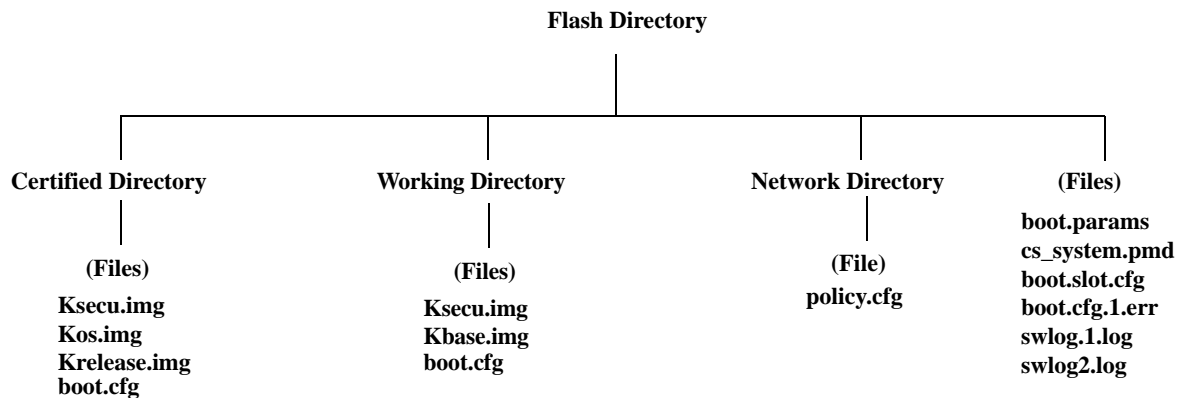

Sample Switch Directory Tree

Determining Your Location in the File Structure

Use the **pwd** command to display the path to your current directory. When you first log into the switch, your current directory is the flash directory. If you enter the **pwd** command, the following will be displayed:

```

-> pwd
/flash

->

```

The display shows the name of the current directory and its path. If your current directory is the certified directory and you enter the **pwd** command, the following will be displayed:

```

-> pwd
/flash/certified

->

```

The display shows the path to your current directory.

Changing Directories

Use the **cd** command to navigate within the file directory structure. The **cd** command allows you to move “up” or “down” the directory tree. To go down, you must specify a directory located in your current directory. The following command example presumes your current directory is the **/flash** file directory as shown in the directory on [page 1-8](#) and that you want to move down the directory tree to the certified directory.

```
->pwd
/flash
->cd certified
->
```

To verify that your current directory has changed to **/flash/certified**, use the **pwd** command and the following will be displayed:

```
->pwd
/flash/certified
```

To move “up” the directory tree, use the **cd** command. Enter **cd..** (**cd** dot dot) without specifying a directory name and your current directory will move up one directory level. If you enter **cd** without the dots, your current directory will move to the top of the tree. The following example shows the **cd** command used where the current directory is **/flash/certified**.

```
->pwd
/flash/certified

-> cd
->
```

To verify that your current directory has moved up the directory tree, use the **pwd** command to display your location. The display shows you have moved up one level from the **/flash/certified** directory and that your current directory is **/flash**.

```
-> pwd
/flash
```

If you use the **cd** command while you are at the top of the directory tree, the **cd** command will have no effect on the location of your login. In other words, if you use **cd** while your current directory is **/flash**, your current directory will remain **/flash** after you execute the **cd** command.

Displaying Directory Contents

The **ls** and **dir** commands have the same function. These two commands display the contents of the current directory. If you use the **ls** or **dir** command while logged into the **/flash** file directory of the switch as shown on [page 1-8](#), the following will be displayed:

```
-> dir

Listing Directory /flash:

drw      512 Oct 25 14:39 certified/
drw      512 Jul 15 14:59 NETWORK/
drw      512 Oct 25 14:17 WORKING/
-rw      321 Oct 25 14:39 boot.params
-rw     163258 Oct  2 11:04 cs_system.pmd
-rw       11 Jul 30 14:09 boot.slot.cfg
-rw      693 Oct  9 11:55 boot.cfg.1.err
-rw       0 Oct 28 11:14 swlog1.log
-rw     64000 Oct 29 09:12 swlog2.log

9467904 bytes free
```

If you specify a path as part of the **ls** or **dir** command, your screen will list the contents of the directory at the specified path.

```
-> ls /flash/certified

Listing Directory /flash/certified:

drw      2048 Oct 12 11:16 ./
drw      2048 Oct 12 15:58 ../
-rw      2636 Oct 12 11:16 boot.cfg
-rw     860086 Oct 26 11:07 Kos.img
-rw     123574 Oct 14 10:54 Ksecu.img
-rw     123574 Oct 14 10:54 Krelease.img
```

If you use the **ls** or **dir** command while logged into the **/flash** file directory, the following will be displayed.

```
-> dir

Listing Directory /flash:

drw      1024 Nov  8 08:30 WORKING/
-rw       276 Nov  8 09:59 boot.params
-rw     4890749 Oct 21 21:43 cs_system.pmd
-rw       256 Nov  8 09:57 random-seed
-rw     64000 Nov  8 09:59 swlog1.log
drw      1024 Nov  8 08:31 certified/
drw      1024 Nov  8 08:29 NETWORK/
drw      1024 Nov  8 08:29 SWITCH/
-rw       222 Nov  8 09:59 boot.cfg.1.err
-rw     524288 Oct 31 10:51 u-boot.bin
-rw     834497 Oct 31 10:50 miniboot.uboot
-rw     64000 Nov  8 10:56 swlog2.log
-rw       719 Nov  6 12:07 test020
-rw     199567 Nov  5 11:16 rule930.txt

63308800 bytes free
```

If you specify a path as part of the **ls** or **dir** command, your screen will list the contents of the directory at the specified path.

```
-> ls /flash/

Listing Directory /flash:

drw      1024 Nov  8 08:30 WORKING/
-rw      276 Nov  8 09:59 boot.params
-rw    4890749 Oct 21 21:43 cs_system.pmd
-rw      256 Nov  8 09:57 random-seed
-rw     64000 Nov  8 09:59 swlog1.log
drw      1024 Nov  8 08:31 certified/
drw      1024 Nov  8 08:29 NETWORK/
drw      1024 Nov  8 08:29 SWITCH/
-rw      222 Nov  8 09:59 boot.cfg.1.err
-rw    524288 Oct 31 10:51 u-boot.bin
-rw    834497 Oct 31 10:50 miniboot.uboot
-rw     64000 Nov  8 10:56 swlog2.log
-rw       719 Nov  6 12:07 test020
-rw    199567 Nov  5 11:16 rule930.txt

        63308800 bytes free
```

Making a New Directory

To make a new directory use the **mkdir** command. You may specify a path for the new directory. Otherwise, the new directory will be created in your current directory. The syntax for this command requires a slash (/) and no space between the path and the new directory name. Also, a slash (/) is required at the beginning of your path specification.

Note. Your login account must have write privileges to execute the **mkdir** command.

The following command makes a new directory in the working directory on an OmniSwitch:

```
-> mkdir /flash/working/newdir1
```

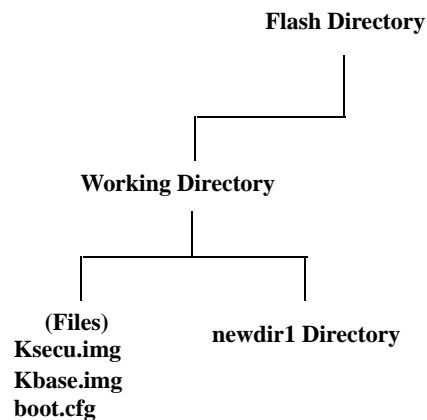

This drawing represents the content of the **/flash/working** directory after the new directory is added.

Displaying Directory Contents Including Subdirectories

The **ls -r** command displays the contents of your current directory in addition to recursively displaying all subdirectories. The following example shows the result of the **ls -r** command where the **/flash/working** directory contains a directory named **newdir1**. Be sure to include a space between **ls** and **-r**.

```
-> ls -r /flash/working
```

Listing Directory /flash/working:

```
drw      2048 Oct 14 17:14 ./
drw      2048 Oct 14 17:12 ../
drw      2048 Oct 14 17:14 newdir1/
-rw      2636 Oct 12 11:16 boot.cfg
-rw     123574 Oct 14 10:54 Kbase.img
-rw     123574 Oct 14 10:54 Ksecu.img
```

Listing Directory /flash/working/newdir1:

```
drw      2048 Oct 14 17:14 ./
drw      2048 Oct 14 17:14 ../
```

Copying an Existing Directory

The **cp -r** command recursively copies directories, as well as any associated subdirectories and files. Before using this command, you should make sure you have enough memory space in your target directory to hold the new material you are copying.

Note. Your login account must have write privileges to execute the **cp -r** command.

In this example, a copy of the working directory and all its contents will be created in the certified directory of an OmniSwitch. The destination directory must exist before the **cp -r** command will work.

```
->cp -r /flash/working flash/certified/working
```

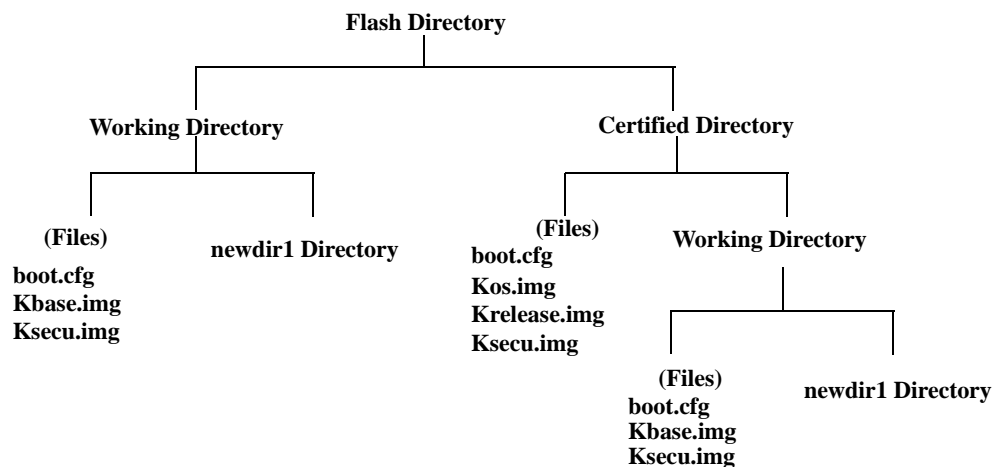

To verify the creation of the new directory, use the `ls -r` command to produce a list of the contents of the certified directory. This list will include the files that were originally in the certified directory plus the newly created copy of the working directory and all its contents.

```
->ls -r /flash/certified

Listing Directory /flash/certified

drw      2048 Oct 12 16:22 ./
drw      2048 Oct 15 10:16 ../
-rw      4347 Oct  2 12:25 boot.cfg
-rw     844217 Oct 25 14:21 Kos.img
-rw      4658 Oct 25 14:21 Krelease.img

Listing Directory /flash/certified/working

drw      2048 Oct 14 17:14 ./
drw      2048 Oct 14 17:12 ../
drw      2048 Oct 14 17:14 newdir1/
-rw      4347 Oct  2 12:25 boot.cfg
-rw     142830 Oct 25 14:17 Ksecu.img
-rw     2743945 Oct 25 14:16 Kbase.img
-rw     844217 Oct 25 14:17 Kos.img

Listing Directory /flash/certified/working/newdir:

drw      2048 Oct 14 17:14 ./
drw      2048 Oct 14 17:14 ../
```

Removing a Directory and its Contents

The `rmdir` command removes the specified directory and all its contents. If the following command is issued from the flash directory shown in the drawing on [page 1-8](#), the working directory would be removed from the certified directory.

```
->rm -r /flash/certified/working
```

Note. Your login account must have write privileges to execute the `rmdir` command.

File Commands

The file commands apply to files located in the **/flash** file directory and its sub-directories.

Note. Each file in any directory must have a unique name. If you attempt to create or copy a file into a directory where a file of the same name already exists, you will overwrite or destroy one of the files.

Creating or Modifying Files

The switch has an editor for creating or modifying files. The editor is invoked by entering the **vi** command and the name of the new file or existing file that you want to modify. For example:

```
-> vi /flash/my_file
```

This command puts the switch in editor mode for **my_file**. If **my_file** does not already exist, the switch will create the file in the flash directory. In the editing mode, the switch uses command keystrokes similar to any vi UNIX text editor. For example, to quit the edit session and save changes to the file, type **ZZ** to return to the CLI prompt.

Copy an Existing File

Use the **cp** command to copy an existing file. You can specify the path and filename for the original file being copied as well as the path and filename for the new copy being created. If no path is specified, the command assumes the current directory. The following syntax copies the **Kos.img** file from the working directory to the certified directory.

```
->cp /flash/working/Kos.img /flash/certified
```

This second example presumes that the user current directory is the **/flash/working** directory. Here, it is not necessary to specify a path for the original file. A copy of **Kos.img** will appear in the **/flash/certified** directory once the following command is executed.

```
->cp Kos.img /flash/certified
```

This third example presumes that the user current directory is the flash directory. To copy a file into the same directory where the file currently exists, the user must specify a new filename. The following command will result in the **Kbase.img** file being copied into the **/flash/working** directory under the new name of **newfile.img**. Both **Kos.img** and its copy **newfile.img** will appear in the **/flash/working** directory.

```
->cp /flash/working/Kbase.img newfile.img
```

In these examples, a new file will be written to the specified or assumed path with the new filename. If you do not specify a new filename, the new file will have the same name as the copied file. If you copy a file to its own directory, you must specify a new filename. In each case, the file being copied will remain in its original location.

Note. You must have write privileges in order to execute the **cp** command.

Secure Copy an Existing File

Use the **scp** command to copy an existing file in a secure manner. You can specify the path and filename for the original file being copied as well as the path and filename for a new copy being created. If no path is specified, the command assumes the current directory. If SCP is not enabled on the switch, use the **scp-sftp** command to enable it. The following syntax copies all of the image files in the working directory from a remote switch 172.17.11.13 to the local working directory:

```
-> scp admin@172.17.11.13:/flash/working/*.img /flash/working
admin's password for keyboard-interactive method:
```

This second example helps copy all the image files from the user current working directory to the remote switch working directory. A copy of all the image files will appear in the **/flash/working** directory of the remote switch 172.17.11.13, once the following command is executed.

```
-> scp /flash/working/*.img admin@172.17.11.13:/flash/working
admin's password for keyboard-interactive method:
```

Note. The **scp** command prompts you to enter the admin password. On entering the admin password, the names and the path of the files being copied will be displayed. SCP is not supported between OmniSwitch and Windows in the current release.

You must have write privileges in order to execute the **scp** command.

Move an Existing File or Directory

The **move** and **mv** commands have the same function and use the same syntax. Use these commands to move an existing file or directory to another location. You can specify the path and name for the file or directory being moved. If no path is specified, the command assumes the current path. You can also specify a path and a new name for the file or directory being moved. If no name is specified, the existing name will be used.

Note. Your login account must have write privileges to use the **move** or **mv** command.

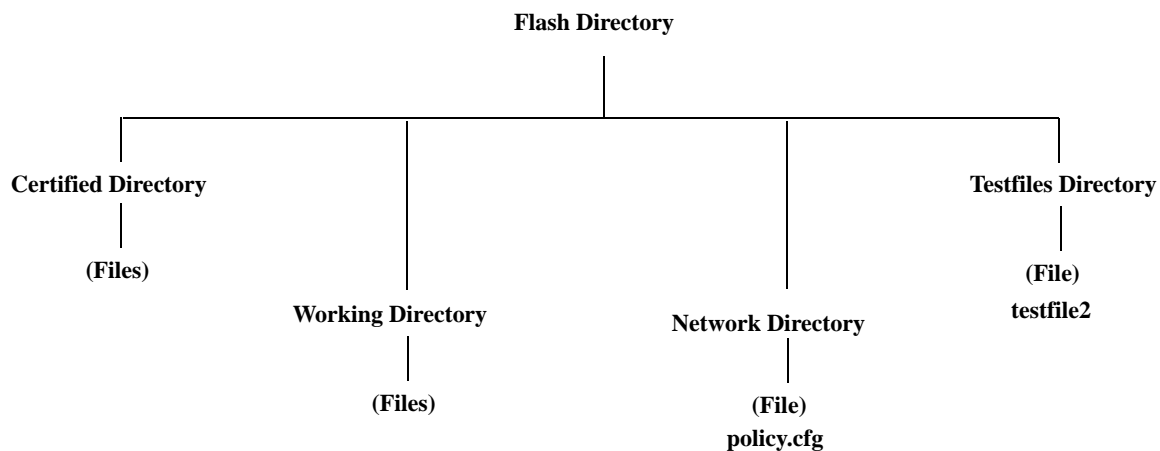

In this first example, the user current directory is the flash directory. The following command syntax moves the **testfile2** file from the user created testfiles directory into the working directory as shown in the illustration above. The screen displays a warning that the file is being renamed (or in this case, redirected).

```
-> move /flash/testfiles/testfile2 /flash/working/testfile2
WARNING:renaming file /flash/testfiles/testfile2 -> /flash/working/testfile2
```

In the next example, the user current directory is the **/flash/testfiles** directory as shown in the illustration, so it is not necessary to specify a path for the file being copied. However, the command syntax specifies a path to the destination directory. The screen displays a warning that the file is being renamed.

```
-> move testfile2 /flash/working/newtestfile2
WARNING:renaming file /flash/working/newtestfile2 -> /flash/working/newtestfile2
```

In this third example, the user current directory is the flash directory. Here, it is not necessary to specify a path for the destination file but a path must be specified for the original file. The screen displays a warning that the file is being renamed.

```
-> move /flash/testfiles/testfile2 newfile2
WARNING: renaming file /flash/testfiles/testfile2 -> /flash/testfiles/newfile2
```

In each of the above examples, a new file will be written to the specified or assumed path with the new filename. In each case, the file being copied will be removed from its original location.

Change File Attribute and Permissions

The **chmod** and **attrib** commands have the same function and use the same syntax. Use these commands to change read-write privileges for the specified file. The following syntax sets the privilege for the **config1.txt** file to read-write. In this example, the user current directory is the **/flash** file directory.

Note. You must have read-write privileges to a file to change that file privileges.

To set the permission for the **config1.txt** file to read-only, use the following syntax.

```
-> chmod -w /flash/config1.txt
```

To set the permission for the **config1.txt** file to read/write, use the following syntax.

```
-> chmod +w /flash/config1.txt
```

Delete an Existing File

The delete command deletes an existing file. If you use the **delete** command from the directory containing the file, you do not need to specify a path. If you are in another directory, you must specify the path and name for the file being deleted. The user of this command must have write privileges for any file being deleted.

```
-> delete /flash/config.txt
```

Managing Files on Switches

On OmniSwitch stackable switches, you can copy a file from a non-primary switch to the primary switch in a stack using the **rcp** command. To use this command, enter **rcp** followed by the slot number of the non-primary switch, the path and file name of the source file on the non-primary switch, and the destination file name on the primary switch.

For example, to copy the **boot.params** file to the **/flash** directory on Switch 4 in a stack to the primary switch and name it **boot.params.bak**, enter:

```
-> rcp 4:/flash/boot.params boot.params.bak
```

On OmniSwitch chassis-based switches, you can copy a file from a secondary management module to a primary management module or from a primary management module to a secondary management module with the **rcp** command. To use this command enter **rcp** followed the secondary management module of the switch, the path and file name of the source file on the secondary management module of the switch, and the destination file name on the primary management module of the switch.

For example, to copy the **boot.params** file to the **/flash** directory on primary management module in a switch and name it **boot.params.bak** enter:

```
-> rcp cmm-b: /flash/boot.params boot.params.bak
```

To delete a file on a secondary management module of the non-primary switch, use the **rrm** command. To use this command, enter **rrm** followed by the path and file name of the file on the secondary management module of the non-primary switch to be deleted.

For example, to delete the **boot.params** file in the **/flash** directory on a secondary management module of the non-primary switch, enter:

```
-> rrm 4 /flash/boot.params
```

To list the directory contents of a secondary management module of the non-primary switch, use the **rls** command by entering **rls**, followed by the path name of the directory you want to display. (As an option, you can also specify a specific file name to be displayed.)

For example, to display the contents of the **/flash** directory on a secondary management module non-primary switch, enter:

```
-> rls 4 /flash
```

A screen similar to the following will be displayed:

```
-rw      327  Sep 13 16:46  boot.params
drw     1024  Sep 13 16:46  certified/
drw     1024  Sep 13 16:45  working/
-rw    64000  Sep 13 16:46  swlog1.log
-rw    64000  Sep  8 21:24  swlog2.log
drw     1024  Sep 13 16:45  switch/
drw     1024  Sep 10 17:34  network/
-rw       256  Sep 13 16:41  random-seed
drw     1024  Jun 22  1986  tk.dir/
```

Utility Commands

The utility commands include **freespace**, **fsck**, and **newfs**. These commands are used to check memory and delete groups of files.

Displaying Free Memory Space

The **freespace** command displays the amount of free memory space available for use in the switch file system. You may issue this command from any location in the switch directory tree.

```
-> freespace
/flash 16480256 bytes free
```

Performing a File System Check

The **fsck** command performs a file system check and can repair any errors found. It displays diagnostic information in the event of file corruption. Note that the **fsck** command only applies to the primary and secondary CMM in an OmniSwitch chassis-based switch or the primary and secondary switch in an OmniSwitch stack.

There are two options available with the **fsck** command: **no-repair** and **repair**. Specifying the **no-repair** option performs only the file system check on the **/flash** directory, whereas, specifying the **repair** option performs the file system check on the **/flash** directory and also repairs any errors found on the file system. If none of the options are specified, then the **no-repair** option is applied by default.

If you want to repair any errors found automatically while performing the file system check, you must specify the flash directory as follows:

```
-> fsck /flash repair
```

The screen displays the following output:

```
/flash/ - disk check in progress ...
/flash/ - Volume is OK
Change volume Id from 0x0 to 0xef2e3c

      total # of clusters: 29,758
      # of free clusters: 18,886
      # of bad clusters: 0
      total free space: 77,357,056
max contiguous free space: 55,451,648 bytes
      # of files: 59
      # of folders: 5
total bytes in files: 44,357,695
      # of lost chains: 0
total bytes in lost chains: 0
```

While performing the repair operation, the switch will display the errors found and specify those errors that have been repaired. If there are no errors found, then just the file system information is displayed.

Deleting the Entire File System

The **newfs** command deletes the flash file system and all the files and directories contained in it. This command is used when you want to reload all files in the file system.

Caution. This command will delete all of the switch system files. All configurations programmed into the switch will be lost. Do not use this command unless you are prepared to reload *all* files.

Process Self-test Function Commands

In the Authenticated Switch Access - Enhanced Mode, an option is provided to check the hardware and software status during boot up. The following commands can be used to perform a self-test for the hardware components and software processes sanity as and when necessary.

Note. This functionality is applicable only in ASA enhanced mode. For more information on ASA mode commands, refer to the “AAA Commands” chapter of the *OmniSwitch AOS Release 6 CLI Reference Guide*.

To display the major hardware components status, use the **show system hardware-self-test** command. This self test checks the hardware status during boot up.

```
-> show system hardware-self-test
Checking CPU status -> Ok
Checking Memory status -> Ok
Checking Flash Status -> Ok
Checking NI Module status -> Ok
Checking Power Supply status -> Ok
Checking Lanpower Status -> Ok
```

To display the major software process status, use the **show system process-self-test** command:

```
-> show system process-self-test
Checking Chassis Supervision Process .....OK
Checking Configuration Manager Process .....OK
Checking Network Process .....OK
Checking AAA Process .....OK
Checking 802.1x Process .....OK
Checking QoS Process .....OK
Checking VLAN Manager Process .....OK
Checking IP Services Process .....OK
Checking H/W Driver Process .....OK
Checking IPV6 Process .....OK
Checking Layer2 / Switching Process .....OK
Checking Layer3 / Routing Process .....OK
Checking NiSUP Process .....OK
```



Loading Software onto the Switch

There are three common methods for loading software to and from your switch. The method you use depends on your workstation software, your hardware configuration, and the location and condition of your switch. These methods are discussed here.

- **FTP Server**—You can use the switch as an FTP server. If you have FTP client software on your workstation, you can transfer a file to the switch via FTP. This is normally done to load or upgrade the switch software or configurations. For details see [“Using the Switch as an FTP Server” on page 1-21](#).
- **TFTP Client**—You can use the TFTP client functionality on an OmniSwitch 6350, 6450 to transfer software to/from a TFTP server. For details see [“Using TFTP to Transfer Files” on page 1-26](#)
- **FTP Client**—You can use the switch as an FTP client by connecting a terminal to the switch console port and using standard FTP commands. This feature is useful in cases where you do not have access to a workstation with an FTP client. For details see [“Using the Switch as an FTP Client” on page 1-22](#).
- **USB Flash Drive**—You can copy files to and from an Alcatel-Lucent certified USB flash drive connected to the CMM. The switch can also boot from the image files stored on the USB drive using the disaster recovery feature. For details see [“Using the USB Flash Drive” on page 5-33](#).
- **Zmodem**—You can load software directly through the serial port with any terminal emulator that supports the Zmodem protocol. Note that a Zmodem transfer of large files may take several minutes to complete. For details see [“Using Zmodem” on page 1-26](#).

Using the Switch as an FTP Server

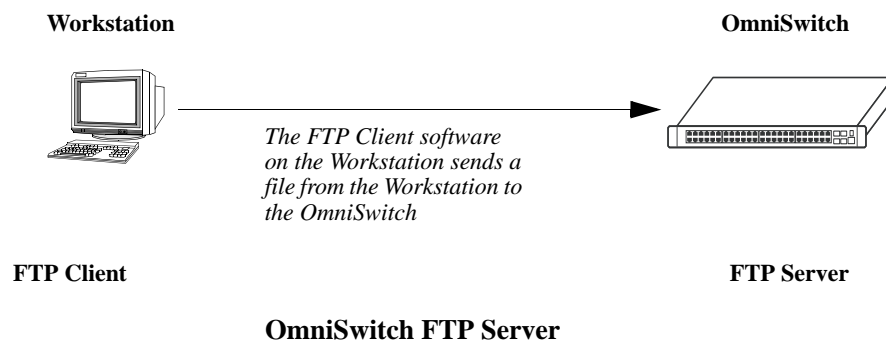
The switch can act as an FTP server for receiving files transferred from your workstation. You can transfer software files to the switch by using standard FTP client software located on a host workstation. This is normally done to load or upgrade the switch software.



The following describes how to transfer files where the switch is acting as an FTP server.

- 1 **Log into the switch.** Use your workstation FTP client software just as you would with any FTP application. To log in to the switch, start your FTP client. Where the FTP client asks for “Name”, enter the IP address of your switch. Where the FTP client asks for “User ID”, enter the username of your login account on the switch. Where the FTP client asks for “Password”, enter your switch password.

Note. If you are using Authenticated Switch Access (ASA), the port interface must be authenticated for FTP use and the username profile must have permission to use FTP. Otherwise the switch will not accept an FTP login. For information about ASA, refer to [Chapter 10, “Managing Switch Security.”](#)

2 Specify the transfer mode. If you are transferring a switch image file, you must specify the binary transfer mode on your FTP client. If you are transferring a configuration file, you must specify the ASCII transfer mode.

3 Transfer the file. Use the FTP “put” command or click the client download button to send the file to the switch.

When you use FTP to transfer a file to the switch, the file is automatically placed in the switch **/flash/working** directory. For details on using CLI commands to managing files once they are on the switch see [“File and Directory Management” on page 1-5.](#)

Note. You must use the binary mode (bin) to transfer files via FTP.

Using the Switch as an FTP Client

Using the switch as an FTP client is useful in cases where you do not have access to a workstation with an FTP client. You can establish an FTP session locally by connecting a terminal to the switch console port. You can also establish an FTP session to a remote switch by using a Telnet session. Once you are logged into the switch as an FTP client, you can use standard FTP commands.

Note. If you are using Authenticated Switch Access (ASA), the port interface must be authenticated for FTP and Telnet use. The login profile must also have permission to use FTP. Otherwise the switch will not accept an FTP login. For information about ASA and user privileges, refer to [Chapter 10, “Managing Switch Security.”](#)

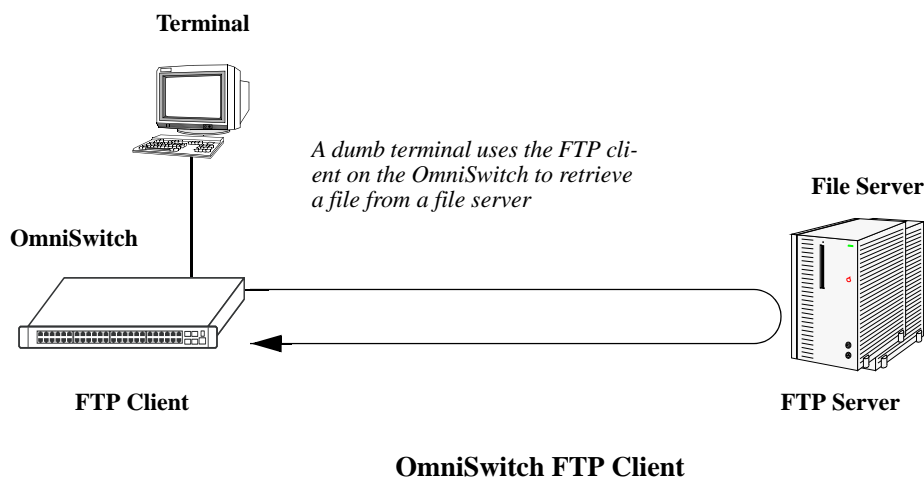

Use the switch **ftp** command to start its FTP client.

- 1 Establish a connection to the switch as explained in “[Getting Started](#)” chapter in your *OmniSwitch AOS Release 6350/6450 Hardware Users Guide*.
- 2 Log on to the switch and enter the **ftp** command to start the FTP client. Next, enter a valid host name or IP address. (For information about enabling the DNS resolver for host names, please refer to [Chapter 2, “Logging Into the Switch.”](#)) A screen similar to the following is displayed:

```
-> ftp 198.23.9.101
Connecting to [198.23.9.101]...connected
220 cosmo FTP server (UNIX(r) System V Release 4.1) ready
Name :
```

Note. You can only use a host name instead of an IP address if the DNS resolver has been configured and enabled. If not, you must specify an IP address.

You can use the **ftp6** command followed by the IPv6 address or the hostname of the FTPv6 server to start an FTPv6 session over an IPv6 environment. For example:

```
-> ftp6 fe80::a00:20ff:fea8:8961 intf1
Connecting to [fe80::a00:20ff:fea8:8961]...connected
220 cosmo FTP server (UNIX(r) System V Release 4.1) ready
Name :
```

Note. While using FTPv6 sessions, it is mandatory to specify the name of the particular IPv6 interface, if the FTPv6 server has been specified using its link-local address.

- 3 Set the client to binary mode with the **bin** command. Enter a valid user name and password for the host you specified with the **ftp** command. A screen similar to the following is displayed:

```
Name: Jsmith
331 Password required for Jsmith
Password: *****
230 User Jsmith logged in.
```

- 4 After logging in, you will receive the **ftp->** prompt. You may enter a question mark (?) to view available FTP commands as shown here.

```
ftp->?

Supported commands:
ascii      binary    bye       cd         delete
dir        get       help      hash      ls
put        pwd      quit      remotehelp user
lpwd      mput     mget     prompt    !ls
lcd        user
```

These are industry standard FTP commands. Their definitions are given in the following table:

ascii	Set transfer type to ASCII (7-bit).
binary	Set transfer type to binary (8-bit).
bye	Close session gracefully.
cd	Change to a new directory on the remote machine.

delete	Delete a file on the remote machine.
dir	Obtain a long listing on the remote machine.
get	Retrieve a file from the remote machine.
hash	Print the hash symbol (#) for every block of data transferred. (This command toggles hash enabling and disabling.)
help	Displays a list of FTP commands and their definitions.
ls	Display summary listing of the current directory on the remote host.
put	Send a file to the remote machine.
pwd	Display the current working directory on the remote host.
quit	Close session gracefully.
remotehelp	List the commands that the remote FTP server supports.
user	Send new user information.
lpwd	Display the current working directory on the local host.
mput	Allows for the transfer of multiple files out of the local machine.
mget	Allows for the transfer of multiple files into the local machine.
prompt	Toggles the query for use with the mput and mget commands.
lls	Lists the contents (files and directories) of the local directory.
lcd	Change to a new local directory
user	Sends new user information.

If you lose communications while running FTP, you may receive a message similar to the following:

```
Waiting for reply (Hit ^C to abort).....
```

In this case you can press **Ctrl-C** to abort the session or wait until the communication failure is resolved and the FTP transfer can continue.

Note. You must use the binary mode (bin) to transfer files via FTP.

Using Secure Shell FTP

1 Log on to the OmniSwitch and issue the **sftp** CLI command. The command syntax requires you to identify the IP address for the device you are connecting to. The following command establishes a Secure Shell FTP interface from the local OmniSwitch to IP address 10.222.30.125.

```
-> sftp 10.222.30.125
login as:
```

Note. If SFTP is not enabled on the switch, use the **scp-sftp** command to enable it.

You can use the **sftp6** command followed by the IPv6 address or hostname of the SFTPv6 server to start an SFTPv6 session over an IPv6 environment. For example:

```
-> sftp6 fe80::a00:20ff:fea8:8961 int1
login as:
```

Note. While using SFTPV6 sessions, it is mandatory to specify the name of the particular IPv6 interface, if the SFTPV6 server has been specified using its link-local address.

2 You must have a login and password that is recognized by the IP address you specify. When you enter your login, the device you are logging in to, will request your password as shown here.

```
-> sftp 10.222.30.125
login as: rrlogin2
rrlogin2's password for keyboard-interactive method:
```

3 After logging in, you will receive the **sftp>** prompt. You may enter a question mark (?) to view available Secure Shell FTP commands and their definitions as shown here.

```
sftp>?
```

Available commands:

cd path	Change remote directory to 'path'
lcd path	Change local directory to 'path'
chmod mode path	Change permissions of file 'path' to 'mode'
help	Display this help text
get remote-path [local-path]	Download file
lls [path]	Display local directory listing
ln oldpath newpath	Symlink remote file
mkdir path	Create local directory
lpwd	Print local working directory
ls [path]	Display remote directory listing
mkdir path	Create remote directory
put local-path [remote-path]	Upload file
pwd	Display remote working directory
exit	Quit sftp
quit	Quit sftp
rename oldpath newpath	Rename remote file
rmdir path	Remove remote directory
rm path	Delete remote file
symlink oldpath newpath	Symlink remote file
version	Show SFTP version
?	Synonym for help

Note. Although Secure Shell FTP has commands similar to the industry standard FTP, the underlying protocol is different.

Closing a Secure Shell FTP Session

To terminate the Secure Shell FTP session, issue the **exit** command. The following will display:

```
-> exit
Connection to 11.333.30.135 closed.
```

This display indicates the Secure Shell FTP session with IP address 11.333.20.135 is closed. The user is now logged into the OmniSwitch as a local device with no active remote connection.

Using TFTP to Transfer Files

Trivial File Transfer Protocol (TFTP), a client-server protocol, can be used to transfer files between the TFTP server and client. TFTP client functionality on the OmniSwitch is used to download files from or upload files to the TFTP server within a LAN using the **tftp** command.

The following is an example of how to start a TFTP session to download a file from a TFTP server:

```
-> tftp 10.211.17.1 get source-file boot.cfg destination-file /flash/working/  
boot.cfg ascii
```

When you enter the above command the following actions are performed:

- Establishes a TFTP session with the TFTP server 10.211.17.1.
- Downloads the boot.cfg file using the ASCII file transfer mode.
- Saves the downloaded file contents to the boot.cfg file in the working directory of the TFTP client.

You can specify a path for the specified file and if the file name is specified without a path then the current path (**/flash**) is used by default. If a destination filename is not specified, then the source filename is used by default. A TFTP client supports two modes of file transfer: Binary mode and ASCII mode. However, files are transferred using the Binary mode by default.

A TFTP server does not prompt for a user to login and only one active TFTP session is allowed at any point of time.

Note. When downloading a file to the switch, the file size must not exceed the available flash space.

Using Zmodem

A Zmodem application has been included with your switch software so that new programs and archives can be uploaded through the switch serial console port. There are generally two situations that would require you to use the switch console serial port to load software by using Zmodem.

- Your system is having problems and the FTP transfer method does not work.
- The switch Ethernet Management port is either not functioning or not configured.

To use Zmodem, you must have a terminal emulator that supports the Zmodem protocol. There are many Zmodem products available that operate differently. You should consult the user manual that came with your terminal emulation software for details.

Note. If a file you are transferring already exists in the switch flash memory, you must remove the file before transferring the new file via Zmodem.

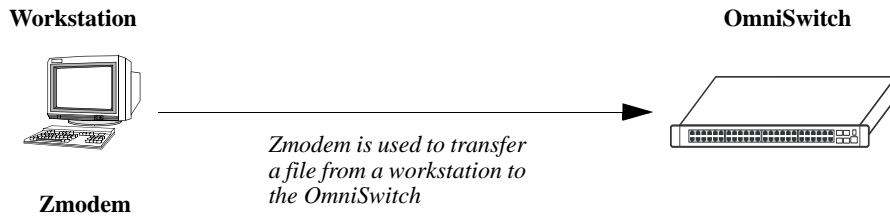

Zmodem File Transfer

To transfer a file via Zmodem, complete the following steps:

- 1 Connect your terminal emulation device containing the Zmodem protocol to the switch console port.
- 2 Start the Zmodem process on your switch by executing the **rz** command.

```
-> rz
```

A screen similar to the following will appear.

```
Upload directory: /flash
rz ready to receive file, please start upload (or send 5 CTRL-X to abort).

**B000000023be50
```

- 3 Transfer the files by using your terminal emulation software. The following will be displayed.

```
ZMODEM file transfer successful,

Hit <RETURN> to exit...
```

When the transfer is complete, you can use the **ls** command to verify that the new files were loaded successfully. To abort a Zmodem session enter **Ctrl-X** five times in succession.

Note. Files transferred via Zmodem are loaded into the flash directory. Before the new files can be used by the switch, you must transfer them to the switch **/flash/working** directory and reboot the switch.

Registering Software Image Files

New software transferred to the switch must go through a registration process before it can be used by the switch. The registration process includes two tasks:

- Transfer the new software file(s) to the switch **/flash/working** directory via remote connection.
- Restart the switch to register the software.

Directories on the Switch

When you log into the switch, your current directory is the flash directory. For a factory default switch, the flash directory contains three sub-directories and several files. It is important to understand the relationship of these directories before you load software or edit any of the files. The three directories are described here:

- **Certified directory**—This directory contains configuration files that are certified as the default start-up files for the switch. These are the trusted configuration and binary image files. They will be used in the event of a non-specified reload. Do not attempt to edit these files. The path to this directory is **/flash/certified**.
- **Working directory**—The working directory is a repository for configuration files that you are working on. If you are working on configuration files to develop a custom switch application, you may want to test them before certifying them as the switch default. To do this, you can boot from the files in the working directory while preserving the files in the certified directory. When the files in the working directory are tested and working properly, you may certify them as the switch default files. The files are then copied into the certified directory to replace the old ones. The path to this directory is **/flash/working**.
- **Network directory**—This directory holds files that may be required by servers used for authentication. Other files can be put into this directory if desired. The path to this directory is **/flash/network**.

Note. The upgrade procedure of the image now works in the “Certified” directory and modification of the configuration is reflected correctly in the configuration files of the switch. When you upload a new image into the “Certified” directory and issue a “copy certified working” command, the system is fully synchronized including the running configuration.

For more information on switch directories refer to the “Managing CMM Directory Content” chapter of this manual.

Available Image Files

The following table lists the image files for the OmniSwitch 6450 Series switches. Most of the files listed here are part of the base switch configuration. Files that support an optional switch feature are noted in the table.

Archive File Name	Base or Optional Software	Description
KFbase.img	Base Software	CMM Base
KFeni.img	Base Software	NI image for all Ethernet-type NIs
KFos.img	Base Software	CMM Operating System
KFsecu.img	Base Software	CMM Security

The following table lists the image files for the OmniSwitch 6350 Series switches. Most of the files listed here are part of the base switch configuration. Files that support an optional switch feature are noted in the table.

Archive File Name	Base or Optional Software	Description
KF3base.img	Base Software	CMM Base
KF3eni.img	Base Software	NI image for all Ethernet-type NIs
KF3os.img	Base Software	CMM Operating System
KF3secu.img	Base Software	CMM Security

Note. Some switches may also have image files in flash memory. These files can result from the manufacturing process and are not needed for the switch to function. Therefore, they can be safely deleted.

CodeGuardian

Alcatel-Lucent Enterprise and LGS Innovations have combined to provide the first network equipment to be hardened by an independent group. CodeGuardian promotes security and assurance at the network device level using independent verification and validation of source code, software diversification to prevent exploitation and secure delivery of software to customers.

CodeGuardian employs multiple techniques to identify vulnerabilities such as software architecture reviews, source code analysis (using both manual techniques and automated tools), vulnerability scanning tools and techniques, as well as analysis of known vulnerabilities in third party code.

Software diversification

Software diversification randomizes the executable program so that various instances of the same software, while functionally identical, are arranged differently. The CodeGuardian solution rearranges internal software while maintaining the same functionality and performance and modifies the deliverable application to limit or prevent/impede software exploitation.

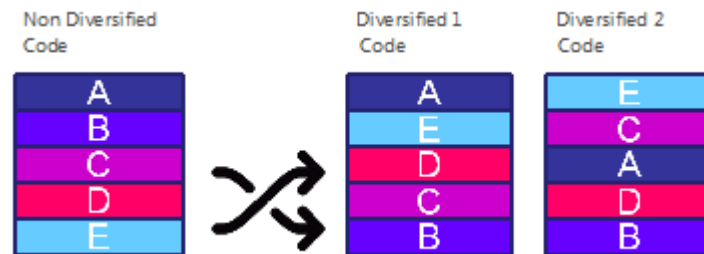

CodeGuardian AOS Releases

Chassis	Standard AOS Release	AOS CodeGuardian Release	LGS AOS CodeGuardian Release
OmniSwitch 6450	6.7.2.R01	6.7.2.RX1	6.7.2.LX1

- X=Diversified image 1-5
- ALE will have 5 different diversified images per AOS release (R11 through R51)
- Our partner LGS will have 5 different diversified images per AOS release (L11 through L51)

Application Examples for File Management

The following sections provide detailed examples of managing files and directories on the switch.

Transferring a File to the Switch Using FTP

In this example, the user is adding a security feature to an OmniSwitch 6450 Series switch. To do this, the user must load the **KFsecu.img** image file onto the switch and then register the file by rebooting the switch. The following steps describe how to transfer the file from the user workstation to the switch by using an FTP client on the workstation:

- 1 Load the **KFsecu.img** file onto a workstation that contains an FTP client.

You will normally receive the file from the Internet, via E-mail, or on CD media. Place the file on your workstation where it can be easily downloaded.

- 2 Run the FTP client software on your workstation.

Most workstations have an FTP client installed. Refer to your manufacturer instructions for details on running the FTP application.

- 3 Log in to the switch from your FTP client.

Where the FTP client asks for Name, enter the IP address of your switch. Where the FTP client asks for User ID, enter "admin". Where the FTP client asks for Password, enter "switch" or your custom configured password.

- 4 Transfer the file from the workstation to the switch by using the FTP client.

If you have a GUI FTP client, select the **KFsecu.img** file on your desktop and click the download button. If you have a text only FTP client, use the FTP "put" command to move the file from your desktop to the switch. In either case, you must specify a binary file transfer because the **KFsecu.img** file is a binary file. Once the transfer is complete, the file will appear in the switch **/flash/working** directory.

- 5 Close the FTP session with the switch.

- 6 To verify that the **KFsecu.img** file is in the **/flash/working** directory on the switch. Log onto the switch and list the files in the **/flash/working** directory.

```
-> ls /flash/working
```

```
Listing Directory /flash/working:
```

```
drw      2048 Aug 4 10:45 ./
drw      2048 Aug 5 14:05 ../
-rw     670979 Aug 5 14:44 KFsecu.img
-rw    2877570 Aug 4 10:33 KFbase.img
-rw    217119 Aug 4 10:33 KFdiag.img
-rw    727663 Aug 4 10:33 KFeNi.img
-rw      5519 Aug 4 10:34 KFrelease.img
-rw       880 Sep 31 13:05 boot.cfg
```

This list verifies that the file is located on the switch in the **/flash/working** directory.

- 7 Reboot the switch to register the security file **KFsecu.img**.

The features and services supported by the **Ksecu.img** image file are now available on the switch.

Creating a File Directory on the Switch

In this example, the user wants to store several test files on the switch for use at a later date. The user has loaded the files into the switch **/flash/working** directory by using FTP. Rather than leaving the files in the working directory, the user may want to create a new directory. The following steps describe how to create a directory on the switch, how to transfer files into the directory, and how to list the files.

- 1 Log onto the switch and use the **mkdir** command to create a new directory called “resources”.

```
-> mkdir resources
->
```

- 2 Verify that the new directory was created using the **ls** command. The “resources” directory is listed.

```
-> ls
Listing Directory /flash:

-rw      308 Aug 12 13:33 boot.params
drw     2048 Aug 14 10:45 certified/
drw     2048 Aug 15 16:24 working/
-rw    64000 Aug 15 16:19 swlog1.log
-rw    64000 Aug 15 14:05 swlog2.log
drw     2048 Sep 24 07:57 switch/
-rw       30 Aug 19 2023 policy.cfg
drw     2048 Aug 25 16:25 resources/
-rw       0 Sep 24 08:00 boot.cfg
```

- 3 Use the **ls** command to list the contents of the **/flash/working** directory.

```
-> ls /flash/working
Listing Directory /flash/working:

drw     2048 Aug 5 17:03 ./
drw     2048 Aug 5 16:25 ../
-rw     880 Sep 31 13:05 boot.cfg
-rw       6 Aug 5 17:03 test1.txt
-rw       6 Aug 5 17:03 test2.txt
-rw       6 Aug 5 17:03 test3.txt
```

- 4 Use the **mv** command to move the test files from **/flash/working** to **/flash/resources**.

```
-> mv test1.txt /flash/resources
-> mv test2.txt /flash/resources
-> mv test3.txt /flash/resources
```

- 5 Use the **ls** command to verify that the files are now located in the **/flash/resources** directory.

```
-> ls /flash/resources
Listing Directory /flash/resources:

drw      2048 Jul  5 17:20 ./
drw      2048 Jul  5 16:25 ../
-rw           6 Jul  5 17:03 test1.txt
-rw           6 Jul  5 17:03 test2.txt
-rw           6 Jul  5 17:03 test3.txt

17995776 bytes free
```

FTP Client Application Example

The following example shows how to transfer a file named **rrtext.txt** from the switch **/flash/working** directory to another host by using the switch as an FTP client.

- 1 Log into the switch. Use the **ls** command to verify that your current directory is **/flash**.

```
-> ls

Listing Directory /flash:

-rw      272 Jun 12 15:57 boot.params
drw     2048 Jun 12 17:52 certified/
drw     2048 Jun 13 12:32 working/
drw     2048 Jul 12 16:22 switch/
-rw    10000 Jun 12 15:58 swlog1.log
-rw    10000 Jun 12 17:50 swlog2.log
-rw      445 Jun 21 11:43 aaasnap
-rw      7298 Jul 24 16:51 websnap1024
-rw   2662306 Jun 28 16:44 cs_system.pmd
-rw      543 Jun 28 12:02 aaapublic
drw     2048 Jun 28 17:50 newdir/
-rw     1452 Jun 29 12:50 nssnap76
-rw     1452 Jun 29 12:42 iesnap76

16480256 bytes free
```

- 2 Use the **cd** command to change your current directory to **/flash/working**. Use the **ls** or **pwd** command to verify.

```
-> cd working
-> ls

Listing Directory /flash/working:

drw      2048 Aug  3 12:32 ./
drw      2048 Aug 14 10:58 ../
-rw       450 Aug 13 10:02 rrtest1.txt
```

- 3 Enter the FTP mode by using the **ftp** command followed by the IP address or the name of the host you are connecting to. (If you enter a host name, please refer to “Using Zmodem” on page 1-26.)

```
->ftp 10.255.11.101
220 Connecting to [10.255.11.101]...connected.
Cosmo Windows FTP server ready
Name: Myhost1
```

Note. You can only use a host name instead of an IP address if the DNS resolver has been configured and enabled. If not, you must specify an IP address.

You can use the **ftp6** command followed by the IPv6 address or hostname of the FTPv6 server to start an FTPv6 session over an IPv6 environment. For example:

```
-> ftp6 fe80::a00:20ff:fea8:8961 intf1
220 Connecting to [fe80::a00:20ff:fea8:8961]...connected.
Cosmo Windows FTP server ready
Name: Myhost1
```

Note. FTPv6 sessions are supported. It is mandatory to specify the name of the particular IPv6 interface, if the FTPv6 server has been specified using its link-local address.

- 4 Enter a valid user name and password for the host you specified with the **ftp** command. A screen similar to the following is displayed:

```
Name (d) : Jsmith
331 Password required for Jsmith
Password: *****
230 User Jsmith logged in.
```

- 5 Use the FTP “put” command to transfer the file from your switch to the host as shown here.

```
ftp> put rrttest.txt
```

The following will be displayed:

```
200 Port set okay
150 Opening BINARY mode data connection
Transferred 20 octets in 1 seconds.
226 Transfer complete
ftp>
```

- 6 To exit the switch FTP client mode, use the “quit” FTP command. Your current directory on the switch is **/flash/working**, which is the location from which you initiated the FTP client session. Use the **pwd** CLI command to verify your current directory.

```
ftp> quit

221 Bye
-> pwd
/flash/working
```

Creating a File Directory Using Secure Shell FTP

The following example describes the steps necessary to create a directory on a remote OmniSwitch and to transfer a file into the new directory by using Secure Shell FTP.

- 1 Log on to the switch and issue the **sftp** CLI command with the IP address for the device you are connecting to. The following command establishes a Secure Shell FTP interface from the local OmniSwitch to another OmniSwitch at IP address 10.222.30.125.

```
-> sftp 10.222.30.125
login as:
```

Note. If SFTP is not enabled, use the **scp-sftp** command to enable it.

You can use the **sftp6** command followed by the IPv6 address or hostname of the SFTPv6 server to start an SFTPv6 session over an IPv6 environment. For example:

```
-> sftp6 fe80::a00:20ff:fea8:8961 int1
login as:
```

Note. SFTPv6 sessions are supported. It is mandatory to specify the name of the particular IPv6 interface, if the SFTPv6 server has been specified using its link-local address.

- 2 You must have a login and password that is recognized by the IP address you are logging in to. When you enter your login, the device will request your password. Here, the login “rrlogin2” is used, the system requests a password.

```
-> sftp 10.222.30.125
login as: rrlogin2
rrlogin2's password for keyboard-interactive method:
```

Once the correct password is given and the login is completed, the **sftp>** prompt is displayed. This indicates that you are in the Secure Shell FTP mode and must, therefore, use the Secure Shell FTP commands as listed on [page 1-25](#).

- 3 Use the **ls** command to display the contents of the target OmniSwitch directory.

```
sftp> ls
 287 boot.params
 2048 certified
 2048 working
64000 swlog1.log
64000 swlog2.log30 policy.cfg
 2048 network
206093 cs_system.pmd
 2048 LPS
 256 random-seed
```

- 4 Use the **mkdir** command to create a new directory entitled “newssdir” in the target OmniSwitch. Remember you must specify the path for the new directory as follows:

```
sftp> mkdir /flash/newssdir
```

- 5 Use the **ls** command again to list the contents of the current (flash) directory. Note that the “newssdir” directory appears toward the bottom of the following list.

```
sftp> ls
```

```
287 boot.params
2048 certified
2048 working
64000 swlog1.log
64000 swlog2.log30 policy.cfg
2048 network
206093 cs_system.pmd
2048 LPS
2048 newssdir
256 random-seed
```

Transfer a File Using Secure Shell FTP

To demonstrate how to transfer a file by using the Secure Shell FTP, this application example continues from the previous example where a new directory named “newssdir” was created on a remote OmniSwitch.

1 Use the Secure Shell FTP **put** command to transfer the file “testfile1.rr” from the local OmniSwitch to the “newssdir” directory on the remote OmniSwitch. You must specify the local path (where the file originates) and the remote path (where the file is going) in the command syntax. The following command is used:

```
sftp> put /flash/testfile1.rr /flash/newssdir
```

The following will be displayed to indicate that the file was successfully transferred to the **/flash/newssdir** on the target OmniSwitch.

```
Uploading /flash/testfile1.rr to /flash/newssdir/testfile1.rr
```

2 To verify that the file was transferred to the correct destination, use the Secure Shell FTP **cd** command to move your login to the newssdir directory. Then, use the **ls** command to list the contents of the directory. The copied file is listed in the correct directory as shown here.

```
sftp> cd newssdir
sftp> ls
2048 .
2048 ..
31 testfile1.rr
```

Closing a Secure Shell FTP Session

To terminate the Secure Shell FTP session, issue the **exit** command. The following will be displayed:

```
-> exit
Connection to 11.333.30.135 closed.
```

This display indicates the Secure Shell FTP session with IP address 11.333.20.135 is closed. The user is now logged into the OmniSwitch as a local device with no active remote connection.

Verifying Directory Contents

To display a list of files, the following CLI commands may be used.

ls	Displays the contents of a specified directory or the current working directory.
dir	Displays the contents of a specified directory or the current working directory.
rls	Displays the content of a non primary switch in a stack.

For more information about these commands, see the *OmniSwitch AOS Release 6 CLI Reference Guide*.

Installing Software Licenses

Some features require a software license and are restricted only to a licensed user. To activate licensed features, a license serial number must be purchased along with an authorization code from Alcatel-Lucent. The authorization code can then be used to generate a license file.

To install the license file on the switch and to activate the licensed features, perform the following steps:

1 Log on to <https://service.esd.alcatel-lucent.com/portal/page/portal/EService/LicenseGeneration> and provide the serial number and MAC address of the switch along with the authorization code.

A license file, for example *lmLicense.txt*, is generated.

2 Save the generated (*lmLicense.txt*) file in the **/flash** directory (or any other directory) of the primary CMM.

3 To install the license on the switch, use the **license apply** command with the generated file name or the license key and reboot the switch. For example:

```
-> license apply file /flash/lmLicense.txt
```

4 To verify the installation, use the **show license info** command.

5 To deactivate a license use the **license remove** command as shown below:

```
-> license remove feature gig ni 1
```

6 To temporarily activate a license use the **license unlock** command as shown below:

```
-> license unlock feature gig ni 1
```

Note. For multiple entries of serial numbers, MAC addresses, and authorization codes, use a CSV formatted file and upload the file on to the website. A single license file is generated for all the switches.

Activation or unlock of license can be performed for the first time using the configuration file. For any subsequent unlocks the **boot.cfg** file must be removed and the switch must be rebooted.

Once the license is applied it is written to the EEPROM and the license file is no longer needed.

Licensed Features

License	Features	Installation Notes
Metro	Ethernet-service OAM (802.1ag, Y-1731, 802.3ah) CPE test head G.8032 IPMC VLAN Dying Gasp SAA MVR Mac Forced Forwarding PPPoE <i>Note: Metro license features are not supported on OmniSwitch 6350.</i>	<p>Switch/Stack must rebooted after installing licenses.</p> <p>Allows SMB models to run Metro features.</p> <p>Metro licenses are installed on the units in a stack only if the keys for all the units are available; all units must have a metro license.</p> <p>If a unit is inserted in the stack without metro license and primary unit has a metro license, new added unit will be put into Pass Thru. Unit in Pass thru can be recovered by installing the metro license.</p> <p>If the unit is inserted in the stack with metro license and primary unit does not have metro license, newly added unit will be put into Pass Thru. Unit in Pass thru can be recovered by removing the Metro license.</p> <p>If unit is inserted in the stack with metro license and primary unit has metro license, newly added unit will not be put into Pass thru.</p> <p>When removing license from primary element it will be removed for all stack elements.</p>
GIG	Enables gigabit interfaces on “lite” models.	<p>No reboot required.</p> <p>Copper ports will be upgraded to provide gigabit capacity.</p> <p>Individual units in a stack can be upgraded.</p>

License	Features	Installation Notes
10GIG	Enables 10-Gigabit non-combo SFP+ ports. <i>Note: 10GIG is not supported on OmniSwitch 6350.</i>	No reboot required. Non-combo SFP+ ports will be upgraded to provide 10G capacity. Individual units can be upgraded.
Temporary	Unlocks any licensed feature for a period of 15 days.	No license file required, can be enabled with CLI. Can only be unlocked if no boot.cfg file exists. Can be re-installed after expiration as long as no boot.cfg file exists.

Setting the System Clock

The switch clock displays time by using a 24-hour clock format. It can also be set for use in any time zone. Daylight Savings Time (DST) is supported for a number of standard time zones. DST parameters can be programmed to support non-standard time zones and time off-set applications.

All switch files and directories listed in the flash directory bear a time stamp. This feature is useful for file management purposes.

Setting Date and Time

You can set the local date, time zone, and time for your switch or you can also set the switch to run on Universal Time Coordinate (UTC or GMT). If applicable, you can also configure Daylight Savings Time (DST or Summertime) parameters.

Note. If you have multiple switches in a stack, you must set the date and time on both the primary and the secondary switch. Otherwise, if you experience a fail-over situation, the secondary switch time and date will not match. You can use the [takeover](#) command to switch between primary and secondary switches to set time and date. For more information on redundancy, refer to [Chapter 5, “Managing CMM Directory Content.”](#)

Date

To display the current system date for your switch, use the [system date](#) command. If you do not specify a new date in the command line, the switch will display the current system date.

To modify the switch current system date, enter the new date with the command syntax. The following command will set the switch system date to June 23, 2002.

```
-> system date 06/23/2002
```

When you specify the date you must use the *mm/dd/yyyy* syntax where *mm* is the month, *dd* is the day and *yyyy* is the year. Months are specified as numbers from 01 to 12. Days are specified as numbers from 1 to 31. You must use two digits to define the month and the day. You must use four digits to specify the year.

Time Zone

To determine the current time zone or to specify a new time zone for your switch, use the [system timezone](#) command. This specifies the time zone for the switch and sets the system clock to run on UTC time (or Greenwich Mean Time). The following is displayed for the Pacific standard time zone:

```
-> system timezone
PST: (Coordinated Universal Time) UTC-8 hours
```

To set a new time zone for the system clock, use the [system timezone](#) command along with the appropriate time zone abbreviation. Refer to the table in [“Enabling DST” on page 1-44](#) for time zone abbreviations. The following command sets the system clock to run on Pacific standard time:

```
-> system timezone pst
PST: (Coordinated Universal Time) UTC-8 hours
```

You may set the switch system clock to a time that is offset from standard UTC time. For example, you can set a time that is offset from UTC by increments of 15, 30, or 45 minutes. You must indicate by a plus (+) or minus (-) character whether the time should be added to or subtracted from the system time. To set a time that offsets UTC by adding 5 hours and 45 minutes, use the following command:

```
-> system timezone +05:45
```

Note that four digits must be used to specify an offset for minutes, and the minutes must be specified in 15, 30, or 45 minute increments. To specify the number of hours offset from UTC (such as ten hours) use the following command syntax:

```
-> system timezone +10
```

Values to specify hours for offset range from -13 through +12.

Time

To display the current local time for your switch, use the **system time** command. If you do not specify a new time in the command line, the current system time is displayed as shown:

```
-> system time
17:08:51 (PST)
```

To modify the switch current system time, enter the **system time** command. When you specify the time you must use the *hh:mm:ss* syntax where *hh* is the hour based on a 24 hour clock. The *mm* syntax represents minutes and *ss* represents seconds. You must use two digits to specify the minutes and two digits to specify the seconds. The following command will set the switch system time to 10:45:00 a.m:

```
-> system time 10:45:00
->
```

The following command will set the switch system time to 3:14:00 p.m:

```
-> system time 15:41:00
->
```

Daylight Savings Time Configuration

The switch can be set to change the system clock automatically to adjust for Daylight Savings Time (DST). There are two situations that apply depending on the time zone selected for your switch.

If the time zone set for your switch shows DST parameters in the table on [page 1-44](#), you need to only enable DST on your switch by using the following command:

```
-> system daylight savings time enable
```

If the time zone set for your switch *does not* show DST parameters in the table on [page 1-44](#), you must specify the start, end, and change parameters for DST by using the **system daylight savings time** command. The following information is needed to specify DST:

- The day of the week and month of the year when DST will begin.
- The position of that day in the month (e.g., first, second, third, fourth, or last Sunday of the month).
- The hour and minute of the day at which DST will begin.
- The day of the week and month of the year when DST will end.
- The position of that day in the month (e.g., first, second, third, fourth, or last Sunday of the month).
- The hour and minute of the day at which DST will end.
- The number of hours the switch clock will be offset for DST (one hour in most cases).

To set the switch DST parameters so that the clock will move back *one hour* on the *fourth Sunday of September at 11:00 p.m.* and move forward on the *fourth Sunday of March at 11:00 a.m.*, the following command should be used:

```
-> system daylight savings time start fourth sun in Sept at 23:00 end fourth sun  
in march at 11:00 by 1
```

For more details on syntax for this command, please refer to the *OmniSwitch AOS Release 6 CLI Reference Guide*. You can also use the question mark (?) character in the command syntax to invoke the CLI help feature as described in the “Using the CLI” chapter of this manual.

Note. By default, Daylight Savings Time is disabled.

Enabling DST

When Daylight Savings Time (DST) is enabled, the switch clock will automatically set the default DST parameters for the time zone specified on the switch or for the custom parameters you can specify with the [system daylight savings time](#) command. In this case, it is not necessary to change the time setting on the switch when your time zone changes to and from DST. To verify the DST parameters for your switch, use the [system daylight savings time](#) command. A screen similar to the following will be displayed:

```
-> system daylight savings time
Daylight Savings Time (DST) is DISABLED.
PST: (Coordinated Universal Time) UTC-8 hours
Daylight Savings Time (DST):
    DST begins on the first sunday in april (4/7) at 2:00
    DST ends on the last sunday in october (10/27) at 2:00
    DST will change the time by +/- 1:00 hour(s)
```

The second line in the above display indicates the Enabled/Disabled status of the DST setting on the switch. The last three lines describe the date and time parameters for the selected time zone or the custom parameters set with the CLI. To enable daylight savings time use the following command:

```
-> system daylight savings time enable
```

Note. If your time zone shows “No default” in the “Time Zone and DST Information Table”, refer to [“Daylight Savings Time Configuration” on page 1-43](#) for information on configuring and enabling DST.

The following table shows a list of supported time zone abbreviations and DST parameters.

Time Zone and DST Information Table

Abbreviation	Name	Hours from UTC	DST Start	DST End	DST Change
nzst	New Zealand	+12:00	1st Sunday in Oct. at 2:00 a.m.	3rd Sunday in Mar. at 3:00 a.m.	1:00
zp11	No standard name	+11:00	No default	No default	No default
aest	Australia East	+10:00	Last Sunday in Oct. at 2:00 a.m.	Last Sunday in Mar. at 3:00 a.m.	1:00
gst	Guam	+10:00	No default	No default	No default
acst	Australia Central Time	+09:30	Last Sunday in Oct. at 2:00 a.m.	Last Sunday in Mar. at 3:00 a.m.	1:00
jst	Japan	+09:00	No default	No default	No default
kst	Korea	+09:00	No default	No default	No default
awst	Australia West	+08:00	No default	No default	No default
zp8	China; Manila, Philippines	+08:00	No default	No default	No default
zp7	Bangkok	+07:00	No default	No default	No default
zp6	No standard name	+06:00	No default	No default	No default
zp5	No standard name	+05:00	No default	No default	No default
zp4	No standard name	+04:00	No default	No default	No default
msk	Moscow	+03:00	Last Sunday in Mar. at 2:00 a.m.	Last Sunday in Oct. at 3:00 a.m.	1:00
eet	Eastern Europe	+02:00	Last Sunday in Mar. at 2:00 a.m.	Last Sunday in Oct. at 3:00 a.m.	1:00

Time Zone and DST Information Table (continued)

Abbreviation	Name	Hours from UTC	DST Start	DST End	DST Change
cet	Central Europe	+01:00	Last Sunday in Mar. at 2:00 a.m.	Last Sunday in Oct. at 3:00 a.m.	1:00
met	Middle Europe	+01:00	Last Sunday in Mar. at 2:00 a.m.	Last Sunday in Oct. at 3:00 a.m.	1:00
bst	British Standard Time	+00:00	Last Sunday in Mar. at 1:00 a.m.	Last Sunday in Oct. at 3:00 a.m.	1:00
wet	Western Europe	+00:00	Last Sunday in Mar. at 1:00 a.m.	Last Sunday in Oct. at 3:00 a.m.	1:00
gmt	Greenwich Mean Time	+00:00	No default	No default	No default
wat	West Africa	-01:00	No default	No default	No default
zm2	No standard name	-02:00	No default	No default	No default
zm3	No standard name	-03:00	No default	No default	No default
nst	Newfoundland	-03:30	1st Sunday in Apr. at 2:00 a.m.	Last Sunday in Oct. at 2:00 a.m.	1:00
ast	Atlantic Standard Time	-04:00	2nd Sunday in Mar. at 2:00 a.m.	1st Sunday in Nov. at 2:00 a.m.	1:00
est	Eastern Standard Time	-05:00	2nd Sunday in Mar. at 2:00 a.m.	1st Sunday in Nov. at 2:00 a.m.	1:00
cst	Central Standard Time	-06:00	2nd Sunday in Mar. at 2:00 a.m.	1st Sunday in Nov. at 2:00 a.m.	1:00
mst	Mountain Standard Time	-07:00	2nd Sunday in Mar. at 2:00 a.m.	1st Sunday in Nov. at 2:00 a.m.	1:00
pst	Pacific Standard Time	-08:00	2nd Sunday in Mar. at 2:00 a.m.	1st Sunday in Nov. at 2:00 a.m.	1:00
astcam	Atlantic Standard Time Central America	-04:00	1st Sunday in Apr. at 2:00 a.m.	Last Sunday in Oct. at 2:00 a.m.	1:00
estcam	Eastern Standard Time Central America	-05:00	1st Sunday in Apr. at 2:00 a.m.	Last Sunday in Oct. at 2:00 a.m.	1:00
cstcam	Central Standard Time Central America	-06:00	1st Sunday in Apr. at 2:00 a.m.	Last Sunday in Oct. at 2:00 a.m.	1:00
mstcam	Mountain Standard Time Central America	-07:00	1st Sunday in Apr. at 2:00 a.m.	Last Sunday in Oct. at 2:00 a.m.	1:00
pstcam	Pacific Standard Time Central America	-08:00	1st Sunday in Apr. at 2:00 a.m.	Last Sunday in Oct. at 2:00 a.m.	1:00
akst	Alaska	-09:00	1st Sunday in Apr. at 2:00 a.m.	Last Sunday in Oct. at 2:00 a.m.	1:00
hst	Hawaii	-10:00	No default	No default	No default
zm11	No standard name	-11:00	No default	No default	No default

2 Logging Into the Switch

Logging into the switch may be done locally or remotely. Management tools include: the Command Line Interface (CLI), which may be accessed locally through the console port, or remotely through Telnet; WebView, which requires an HTTP client (browser) on a remote workstation; and SNMP, which requires an SNMP manager (such as Alcatel-Lucent OmniVista or HP OpenView) on the remote workstation. Secure sessions are available using the Secure Shell interface; file transfers are done through FTP or Secure Shell FTP.

In This Chapter

This chapter describes the basics of logging into the switch to manage the switch through the CLI. It also includes the information about using Telnet, FTP, and Secure Shell in both IPv4 and IPv6 environments for logging into the switch as well as information about using the switch to start a Telnet or Secure Shell session on another device. It also includes information about managing sessions and specifying a DNS resolver. For more details about the syntax of referenced commands, see the *OmniSwitch AOS Release 6 CLI Reference Guide*.

Configuration procedures described in this chapter include:

- [“Quick Steps for Logging Into the Switch” on page 2-5](#)
- [“Using Telnet” on page 2-8](#)
- [“Using FTP” on page 2-10](#)
- [“Using Secure Shell” on page 2-12](#)
- [“Modifying the Login Banner” on page 2-22](#)
- [“Configuring Login Parameters” on page 2-24](#)
- [“Enabling the DNS Resolver” on page 2-25](#)

Management access is disabled (except through the console port) unless specifically enabled by a network administrator. For more information about management access and methods, use the table here as a guide:

For more information about...	See...
Enabling or “unlocking” management interfaces on the switch	Chapter 10, “Managing Switch Security”
Authenticating users to manage the switch	Chapter 10, “Managing Switch Security”
Creating user accounts directly on the switch	Chapter 9, “Managing Switch User Accounts”
Using the CLI	Chapter 6, “Using the CLI”
Using WebView to manage the switch	Chapter 11, “Using WebView”
Using SNMP to manage the switch	Chapter 3, “Using SNMP and OpenFlow”

Login Specifications

Platforms Supported	OmniSwitch 6350, 6450
Telnet clients supported	Any standard Telnet client
FTP clients supported	Any standard FTP client
HTTP (WebView) clients supported	<ul style="list-style-type: none"> – Internet Explorer for Windows NT, Windows XP, and Windows 2000, version 6.0 – Netscape for Windows NT, Windows XP, and Windows 2000, version 7.1 – Netscape for Sun OS 2.8, version 4.79 – Netscape for HP-UX 11.0, version 4.79
Secure Shell clients supported	Any standard Secure Shell client (Secure Shell Version 2)
Secure Shell public key authentication	Password DSA Public Key RSA Public Key
SNMP clients supported	Any standard SNMP manager (such as HP Open-View)

Login Defaults

Access to managing the switch is always available for the **admin** user through the console port, even if management access to the console port is disabled.

Parameter Description	Command	Default
Session login attempts allowed before the TCP connection is closed.	session login-attempt	3 attempts
Time-out period allowed for session login before the TCP connection is closed.	session login-timeout	55 seconds
Inactivity time-out period. The length of time the switch can remain idle during a login session before the switch will close the session.	session timeout	4 minutes

The following table describes the maximum number of sessions allowed on an OmniSwitch:

Session	OmniSwitch 6350/ OmniSwitch 6450
Telnet (v4 or v6)	6
FTP (v4 or v6)	4

Session	OmniSwitch 6350/ OmniSwitch 6450
SSH + SFTP (v4 or v6 secure sessions)	8
HTTP	4
Total Sessions	20
SNMP	50

Quick Steps for Logging Into the Switch

The following procedure assumes that you have set up the switch as described in the *OmniSwitch AOS Release 6350/6450 Hardware Users Guide*. Setup includes:

- Connecting to the switch through the console port.
- Setting up the Ethernet Management Port (EMP) through the switch's boot prompt.
- Enabling (or "unlocking") management interfaces types (Telnet, FTP, HTTP, SNMP, and Secure Shell) through the **aaa authentication** command for the interface you are using. Note that Telnet, FTP, and Secure Shell are used to log into the switch's Command Line Interface (CLI). For detailed information about enabling session types, see [Chapter 10, "Managing Switch Security"](#)

1 If you are connected to the switch through the console port, your terminal automatically displays the switch login prompt. If you are connected remotely, you must enter the switch IP address in your Telnet, FTP, or Secure Shell client (typically the IP or IPv6 address of the EMP). The login prompt then displays.

2 At the login prompt, enter the **admin** username. At the password prompt, enter the **switch** password. (Alternately, you may enter any valid username and password.) The switch's default welcome banner is displayed, followed by the CLI prompt.

```
Welcome to the Alcatel-Lucent OmniSwitch 6450
Software Version 6.7.1.20.R02 Development, March 21, 2016.
```

```
Copyright (c), ALE USA Inc., 2016. All Rights reserved.
```

```
OmniSwitch(TM) is a trademark of Alcatel-Lucent Enterprise registered
in the United States Patent and Trademark Office.
```

You are now logged into the CLI. For information about changing the welcome banner, see ["Modifying the Login Banner" on page 2-22](#).

For information about changing the login prompt, see [Chapter 6, "Using the CLI."](#)

For information about setting up additional user accounts locally on the switch, see [Chapter 9, "Managing Switch User Accounts."](#)

Overview of Switch Login Components

Switch access components include access methods (or interfaces) and user accounts stored on the local user database in the switch and/or on external authentication servers. Each access method, except the console port, must be enabled or “unlocked” on the switch before users can access the switch through that interface.

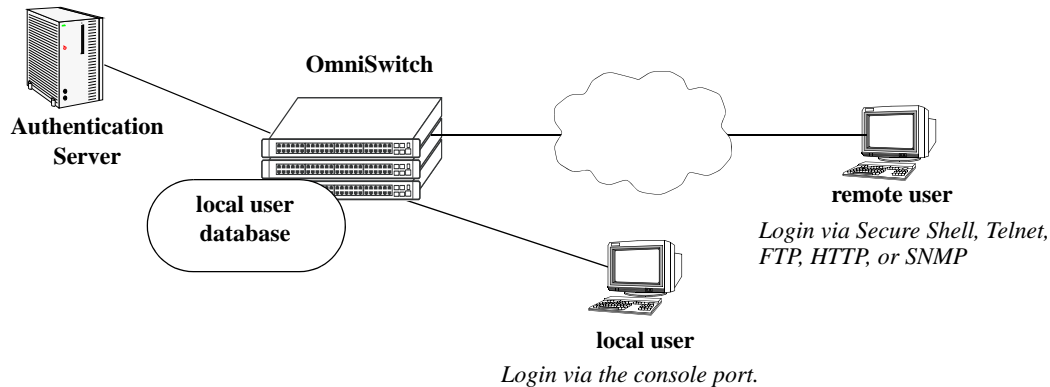

Switch Login Components

Management Interfaces

Logging into the switch may be done locally or remotely. Remote connections may be secure or insecure, depending on the method. Management interfaces are enabled using the **aaa authentication** command. This command also requires specifying the external servers and/or local user database that is used to authenticate users. The process of authenticating users to manage the switch is called Authenticated Switch Access (ASA). Authenticated Switch Access is described in detail in [Chapter 10, “Managing Switch Security”](#)

An overview of management methods is listed here:

Logging Into the CLI

- **Console port**—A direct connection to the switch through the console port. The console port is always enabled for the default user account. For more information about connecting to the console port, see *OmniSwitch AOS Release 6350/6450 Hardware Users Guide*.
- **Telnet**—Any standard Telnet client may be used for remote login to the switch. This method is not secure. For more information about using Telnet to access the switch, see [“Using Telnet” on page 2-8](#).
- **FTP**—Any standard FTP client may be used for remote login to the switch. This method is not secure. See [“Using FTP” on page 2-10](#).
- **Secure Shell**—Any standard Secure Shell client may be used for remote login to the switch. See [“Using Secure Shell” on page 2-12](#).

Using the WebView Management Tool

- **HTTP**—The switch has a Web browser management interface for users logging in through HTTP. This management tool is called WebView. For more information about using WebView, see [Chapter 11, “Using WebView.”](#)

Using SNMP to Manage the Switch

- **SNMP**—Any standard SNMP browser may be used for logging into the switch. See [Chapter 3, “Using SNMP and OpenFlow.”](#)

User Accounts

User accounts may be configured and stored directly on the switch, and user accounts may also be configured and stored on an external authentication server or servers.

The accounts include a username and password. In addition, they also specify the user’s privileges or end-user profile, depending on the type of user account. In either case, the user is given read-only or read-write access to particular commands.

- **Local User Database**

See [Chapter 9, “Managing Switch User Accounts,”](#) for information about creating accounts on the switch.

- **External Authentication Servers**

The switch may be set up to communicate with external authentication servers that contain user information. The user information includes usernames and passwords; it may also include privilege information or reference an end-user profile name.

For information about setting up the switch to communicate with external authentication servers, see the *OmniSwitch AOS Release 6 Network Configuration Guide*.

Using Telnet

Telnet may be used to log into the switch from a remote station. All of the standard Telnet commands are supported by software in the switch. When Telnet is used to log in, the switch acts as a Telnet server. If a Telnet session is initiated from the switch itself during a login session, then the switch acts as a Telnet client.

Logging Into the Switch Through Telnet

Before you can log into the OmniSwitch using a Telnet interface, the **telnet** option of the **aaa authentication** command must be enabled. Once enabled, any standard Telnet client may be used to log into the switch. To log into the switch, open your Telnet application and enter the switch's IP address (the IP address is the same as the one configured for the EMP). The switch's welcome banner and login prompt is displayed.

Note. A Telnet connection is not secure. Secure Shell is recommended instead of Telnet or FTP as a secure method of accessing the switch.

Starting a Telnet Session from the Switch

At any time during a login session on the switch, you can initiate a Telnet session to another switch (or some other device) by using the **telnet** CLI command and the relevant IP address or hostname. You can also establish a Telnetv6 session by using the **telnet6** command and the relevant IPv6 address or hostname.

The following shows an example of telnetting to another OmniSwitch with an IP address of 10.255.10.123:

```
-> telnet 10.255.10.123
Trying 10.255.10.123...
Connected to 10.255.10.123.
Escape character is '^]'.
login :
```

The following is an example of telnetting to another OmniSwitch with an IPv6 address of fe80::a00:20ff:fea8:8961:

```
-> telnet6 fe80::a00:20ff:fea8:8961 intf1
Trying fe80::a00:20ff:fea8:8961...
Connected to fe80::a00:20ff:fea8:8961.
Escape character is '^]'.
login :
```

Note. It is mandatory to specify the name of the particular IPv6 interface, if the target has been specified using the link-local address.

Here, you must enter a valid username and password. Once login is complete, the OmniSwitch welcome banner is displayed as follows:

```
login : admin
password :
```

```
Welcome to the Alcatel-Lucent OmniSwitch 6450
Software Version 6.7.1.20.R02 Development, March 21, 2016.
```

```
Copyright(c), ALE USA Inc., 2016. All Rights reserved.
```

```
OmniSwitch(TM) is a trademark of Alcatel-Lucent Enterprise registered
in the United States Patent and Trademark Office.
```

Using FTP

The OmniSwitch can function as an FTP server. Any standard FTP client may be used.

Note. An FTP connection is not secure. Secure Shell is recommended instead of FTP or Telnet as a secure method of accessing the switch.

Using FTP to Log Into the Switch

You can access the OmniSwitch with a standard FTP application. To log in to the switch, start your FTP client. Where the FTP client asks for “Name”, enter the IP address of your switch. Where the FTP client asks for “User ID”, enter the username of your login account on the switch. Where the FTP client asks for “Password”, enter your switch password.

You can use the switch as an FTP client in a case where you do not have access to a workstation with an FTP client. You can establish an FTP session locally by connecting a terminal to the switch console port. You can also establish an FTP session to a remote switch by using a Telnet session. Once you are logged into the switch as an FTP client, you can use standard FTP commands.

You can use the switch **ftp** command to start an FTP session followed by the relevant IP address or host-name, and the **ftp6** command to start an FTPv6 session followed by relevant IPv6 address or hostname over an IPv6 environment. You have to specify the name of the particular IPv6 interface, if the target has been specified using the link-local address.

Note. If you are using Authenticated Switch Access (ASA), the port interface must be authenticated for FTP use and the username profile must have permission to use FTP. Otherwise the switch does not accept an FTP login. For information about ASA, refer to [Chapter 10, “Managing Switch Security.”](#)

The following is an example of how to start an FTP session to an OmniSwitch with an IP address of 198.23.9.101.

```
->ftp 198.23.9.101
Connecting to [198.23.9.101]...connected
220 cosmo FTP server (UNIX(r) System V Release 4.1) ready
Name:
```

You need to enter a valid user name and password for the host you specified with the **ftp** command, after which you will get a screen similar to the following display:

```
Name:Jsmith
331 Password required for Jsmith
Password: *****
230 User Jsmith logged in.
```

The following is an example of how to start an FTPv6 session to an OmniSwitch with an IPv6 address of fe80::a00:20ff:fea8:8961.

```
-> ftp6 fe80::a00:20ff:fea8:8961 intf1
Connecting to [fe80::a00:20ff:fea8:8961]...connected
220 cosmo FTP server (UNIX(r) System V Release 4.1) ready
Name:
```

You have to enter a valid user name and password for the host you specified with the **ftp6** command, after which you will get a screen similar to the following display:

```
Name:Jsmith
331 Password required for Jsmith
Password: *****
230 User Jsmith logged in.
```

Note. It is mandatory to specify the name of the particular IPv6 interface, if the target has been specified using the link-local address.

After logging in, you see the **ftp->** prompt, where you can execute the FTP commands that are supported on the switch. For further information refer to the *OmniSwitch AOS Release 6 CLI Reference Guide*.

Note. You must use the binary mode (bin) to transfer image files through FTP.

Using Secure Shell

The OmniSwitch Secure Shell feature provides a secure mechanism that allows you to log in to a remote switch, to execute commands on a remote device, and to move files from one device to another. Secure Shell provides secure, encrypted communications even when your transmission is between two untrusted hosts or over an unsecure network. Secure Shell protects against a variety of security risks including the following:

- IP spoofing
- IP source routing
- DNS spoofing
- Interception of clear-text passwords and other data by intermediate hosts
- Manipulation of data by users on intermediate hosts

Note. The OmniSwitch supports Secure Shell Version 2 only.

Secure Shell Components

The OmniSwitch includes both client and server components of the Secure Shell interface and the Secure Shell FTP file transfer protocol. SFTP is a subsystem of the Secure Shell protocol. All Secure Shell FTP data are encrypted through a Secure Shell channel.

Since Secure Shell provides a secure session, the Secure Shell interface and SFTP are recommended instead of the Telnet program or the FTP protocol for communications over TCP/IP for sending file transfers. Both Telnet and FTP are available on the OmniSwitch but they do not support encrypted passwords.

Note. Secure Shell may only be used to log into the switch to manage the switch. It cannot be used for Layer 2 authentication *through* the switch.

Secure Shell Interface

The Secure Shell interface is invoked when you enter the **ssh** command, and the Secure Shellv6 interface is invoked by using the **ssh6** command in an IPv6 environment. After the authentication process between the client and the server is complete, the remote Secure Shell interface runs in the same way as Telnet. Refer to [“Starting a Secure Shell Session” on page 2-18](#) to for detailed information.

Configuring the SSH TCP port number

The TCP port number for SSH can be configured using the **ssh** command. For example:

```
-> ssh tcp-port 2048
```

Secure Shell File Transfer Protocol

Secure Shell FTP is the standard file transfer protocol used with Secure Shell version 2. Secure Shell FTP is an interactive file transfer program (similar to the industry standard FTP) which performs all file transfer operations over a Secure Shell connection.

You can invoke the Secure Shell FTP session by using the **sftp** command, and the SFTPV6 session by using the **sftp6** command in an IPv6 environment. Once the authentication phase is complete, the Secure Shell FTP subsystem runs. Secure Shell FTP connects and logs into the specified host, then enters an interactive command mode. Refer to [“Starting a Secure Shell Session” on page 2-18](#) for detailed information.

Secure Shell Application Overview

Secure Shell is an access protocol used to establish secured access to your OmniSwitch. The Secure Shell protocol can be used to manage an OmniSwitch directly or it can provide a secure mechanism for managing network servers through the OmniSwitch.

The drawing below illustrates the Secure Shell being used as an access protocol replacing Telnet to manage the OmniSwitch. Here, the user terminal is connected through the network to the switch.

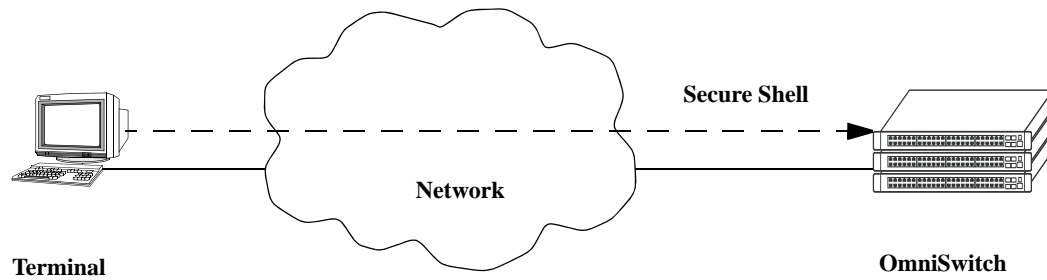

Secure Shell Used as an Access Protocol

The drawing below shows a slightly different application. Here, a terminal connected to a single OmniSwitch, which acts as a Secure Shell client is an entry point to the network. In this scenario, the client portion of the Secure Shell software is used on the connecting OmniSwitch and the server portion of Secure Shell is used on the switches or servers being managed.

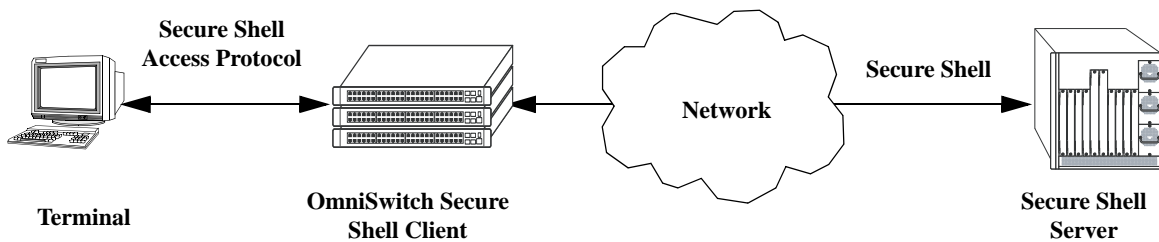

OmniSwitch as a Secure Shell Client

Secure Shell Authentication

Secure Shell authentication is accomplished in several phases using industry standard algorithms and exchange mechanisms. The authentication phase is identical for Secure Shell and Secure Shell FTP. The following sections describe the process in detail.

Protocol Identification

When the Secure Shell client in the OmniSwitch connects to a Secure Shell server, the server accepts the connection and responds by sending back an identification string. The client will parse the server's identification string and send an identification string of its own. The purpose of the identification strings is to validate that the attempted connection was made to the correct port number. The strings also declare the protocol and software version numbers. This information is needed on both the client and server sides for debugging purposes.

At this point, the protocol identification strings are in human-readable form. Later in the authentication process, the client and the server switch to a packet-based binary protocol, which is machine readable only.

Algorithm and Key Exchange

The OmniSwitch Secure Shell server is identified by one or several host-specific keys. Both the client and server process the key exchange to choose a common algorithm for encryption, signature, and compression. This key exchange is included in the Secure Shell transport layer protocol. It uses a key agreement to produce a shared secret that cannot be determined by either the client or the server alone. The key exchange is combined with a signature and the host key to provide host authentication. Once the exchange is completed, the client and the server turn encryption on using the selected algorithm and key. The following elements are supported:

Host Key Types	DSA / RSA
Encryption Algorithms	aes128-ctr,aes192-ctr,aes256-ctr arcfour256,arcfour128 aes128-cbc,3des-cbc,blowfish-cbc,cast128-cbc aes192-cbc,aes256-cbc,arcfour,rijndael-cbc@lysator.liu.se
Data Integrity Algorithms	hmac-md5,hmac-sha1,umac-64@openssh.com,hmac-ripemd160 hmac-ripemd160@openssh.com hmac-sha1-96,hmac-sha2-256,hmac-md5-96
Compression Algorithms	None Supported
Key Exchange Algorithms	diffie-hellman-group-exchange-sha256 diffie-hellman-group-exchange-sha1 diffie-hellman-group14-sha1 diffie-hellman-group1-sha1
Default key location	/flash/network
Default key names	ssh_host_dsa_key.pub (DSA public key) ssh_host_dsa_key (DSA private key) ssh_host_rsa_key.pub (RSA public key) ssh_host_rsa_key (RSA private key)

Note. The OmniSwitch generates a DSA and RSA host keys at initial startup. The key on the switch is made up of two file names contained in the directory above. There is a public key and a private key. To generate a different key, use the Secure Shell tools available on your Unix or Windows system and copy

the files to the specified directory on your switch. The new key takes effect after the OmniSwitch is rebooted.

Authentication Phase

When the client tries to authenticate, the server determines the process used by telling the client which authentication methods can be used. The client has the freedom to attempt several methods listed by the server. The server disconnects itself from the client if a certain number of failed authentications are attempted or if a time-out period expires. Authentication is performed independent of whether the Secure Shell interface or the SFTP file transfer protocol is implemented.

Connection Phase

After successful authentication, both the client and the server process the Secure Shell connection protocol. The OmniSwitch supports one channel for each Secure Shell connection. This channel can be used for a Secure Shell session or a Secure Shell FTP session.

Using Secure Shell DSA Public Key Authentication

The following procedure is used to set up Secure Shell (SSH) DSA public key authentication (PKA) between an OmniSwitch and a client device:

Note. Note that if PKA fails, the user is prompted for a password. This is the password that was specified when the user name was created on the OmniSwitch. Additionally, a similar procedure can be used for RSA.

- 1 Use the PuTTYgen SSH software on the client device to generate a type SSH2 DSA private and public key pair.
- 2 Do not save the public key on the client device using PutTTYgen. Instead, copy the key from the PuTTYgen public key window and paste the key into a text file with the filename **userid_dsa.pub**. Specify a valid OmniSwitch user login name for the *userid* portion of the filename. For example, the following public key filename is for OmniSwitch user Thomas:

thomas_dsa.pub
- 3 Use PuTTYgen to save the private key on the client device.
- 4 Verify that the *userid* specified as part of the filename in Step 2 is a valid user name on the OmniSwitch. If the username does not already exist in the switch configuration, create the user name with the appropriate privileges.
- 5 FTP in ASCII mode the **userid_dsa.pub** file from the client device to the **flash/network/pub** directory on the OmniSwitch. Create the **flash/network/pub** directory first if it does not already exist.
- 6 Using PuTTY software on the client device, access SSH, then Auth, and then select the private key generated in Step 1 to start the authentication process.
- 7 To enforce Secure Shell PKA on a switch use the **ssh enforce pubkey-auth** command.

Note. If a public key file (that is, **thomas_dsa.pub**) exists in the **flash/network/pub** directory on the switch, PKA is still used even if this method of authentication was disabled using the **ssh enforce pubkey-auth** command. Rename, move, or delete the public key file to ensure that PKA is disabled on the switch.

Starting a Secure Shell Session

To start a Secure Shell session, issue the **ssh** command and identify the IP address or hostname for the device you are connecting to.

You can use the **ssh6** command to start an SSHv6 session followed by the relevant IPv6 address or the hostname, over an IPv6 environment.

Note. You can only use a host name instead of an IP address if the DNS resolver has been configured and enabled. If not, you must specify an IP address. See [Chapter 1, “Managing System Files,”](#) for details.

Note. Use of the **cmdtool** OpenWindows support facility is not recommended over Secure Shell connections with an external server.

The following command establishes a Secure Shell interface from the local OmniSwitch to IP address 11.133.30.135:

```
-> ssh 11.133.30.135
login as:
```

Note. If Secure Shell is not enabled on a switch, use the **ssh enable** command to enable it.

You can establish eight SSH sessions towards an OmniSwitch when it acts as Server. A maximum of three SSH sessions are allowed in a minute (utilities such as keyscan is also considered as a valid session). More than three sessions in a minute result in an SSH attack. A minute after an attack, only one SSH session per minute is allowed. If there is no SSH session created for the next three minutes after an attack, a maximum of three SSH sessions are allowed for a minute again.

You must have a login and password that is recognized by the IP address you specify. When you enter your login, the device you are logging in to, requests your password as shown here:

```
-> ssh 11.133.30.135
login as: rrlogin1
rrlogin1's password for keyboard-interactive method:
```

Once the Secure Shell session is established, you can use the remote device specified by the IP address on a secure connection from your OmniSwitch.

Note. The login parameters for Secure Shell session login parameters can be affected by the [session login-attempt](#) and [session login-timeout](#) CLI commands.

The following drawing shows an OmniSwitch, using IP address 11.233.10.145, establishing a Secure Shell session across a network to another OmniSwitch, using IP address 11.133.30.135. To establish this session from the console in the figure below, you would use the CLI commands shown in the examples above. Once you issue the correct password, you are logged into the OmniSwitch at IP address 11.133.30.135.

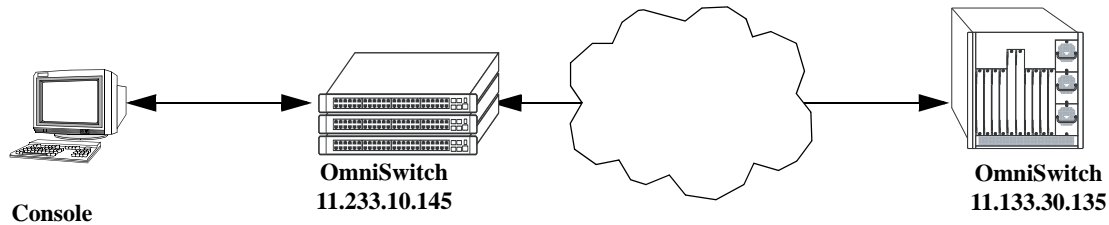

Secure Shell Session between Two OmniSwitches

To view the parameters of the Secure Shell session, issue the **who** command. The following is displayed:

```
-> who

Session number = 0
  User name   = (at login),
  Access type = console,
  Access port = Local,
  IP address  = 0.0.0.0,
  Read-only domains = None,
  Read-only families = ,
  Read-Write domains = None,
  Read-Write families = ,
  End-User profile =
Session number = 1
  User name   = rrlogin1,
  Access type = ssh,
  Access port = NI,
  IP address  = 11.233.10.145,
  Read-only domains = None,
  Read-only families = ,
  Read-Write domains = All ,
  Read-Write families = ,
  End-User profile =
```

This display shows two sessions currently running on the remote OmniSwitch at IP address 11.133.30.135. **Session number 0** is identified as the console session. **Session number 1** indicates the **User name** is rrlogin1, the **IP address** is 11.233.10.145, and the **Access type** is “ssh” which indicates a Secure Shell session.

Note. You can use the **ssh6** command followed by the IPv6 address or the hostname of the SSHv6 server to start an SSHv6 session. It is mandatory to specify the name of the particular IPv6 interface, if the SSHv6 server has been specified using its link-local address.

Closing a Secure Shell Session

To terminate the Secure Shell session, issue the **exit** command. The following is displayed:

```
-> exit
Connection to 11.133.30.135 closed.
```

Using the example shown above, this display indicates the Secure Shell session between the two switches is closed. At this point, the user is logged into the local OmniSwitch at IP address 11.233.10.145.

Note. Establishing and closing the Secure Shellv6 connection is similar to that of the Secure Shell connection.

Log Into the Switch with Secure Shell FTP

To open a Secure Shell FTP session from a local OmniSwitch to a remote device, issue the **sftp** command and identify the IP address or hostname for the device you are connecting to.

You can use the **sftp6** command to start an Secure Shell FTPv6 session followed by the relevant IPv6 address or hostname, over an IPv6 environment.

The following example describes how a Secure Shell interface is established from the local OmniSwitch to IP address 10.222.30.125:

1 Log on to the OmniSwitch and issue the **sftp** CLI command. The command syntax requires you to identify the IP address or hostname for the device to which you are connecting. The following command establishes a Secure Shell FTP interface from the local OmniSwitch to IP address 10.222.30.125.

```
-> sftp 10.222.30.125
login as:
```

Note. If SFTP is not enabled, use the **scp-sftp** command to enable it.

2 You must have a login and password that is recognized by the IP address you specify. When you enter your login, the device you are logging in to, requests your password as shown here.

```
-> sftp 10.222.30.125
login as: rrlogin2
rrlogin2's password for keyboard-interactive method:
```

Note. You can use the **sftp6** command followed by the IPv6 address or hostname of the SFTPv6 server to start an SFTPv6 session. It is mandatory to specify the name of the particular IPv6 interface, if the SFTPv6 server has been specified using its link-local address. After logging in, you see the **sftp>** prompt. You may enter a question mark (?) to view available Secure Shell FTP commands and their definitions as shown here.

```
sftp>?

Available commands:
cd path           Change remote directory to 'path'
lcd path          Change local directory to 'path'
chmod mode path   Change permissions of file 'path' to 'mode'
help              Display this help text
get remote-path [local-path] Download file
lls [path]]       Display local directory listing
ln oldpath newpath Symlink remote file
mkdir path        Create local directory
lpwd              Print local working directory
ls [path]         Display remote directory listing
mkdir path        Create remote directory
put local-path [remote-path] Upload file
pwd               Display remote working directory
exit              Quit sftp
quit              Quit sftp
rename oldpath newpath Rename remote file
rmdir path        Remove remote directory
rm path           Delete remote file
symlink oldpath newpath Symlink remote file
version           Show SFTP version
?                 Synonym for help
```

Note. Although Secure Shell FTP has commands similar to the industry standard FTP, the underlying protocol is different. See [Chapter 1, “Managing System Files,”](#) for a Secure Shell FTP application example.

Closing a Secure Shell FTP Session

To terminate the Secure Shell FTP session, issue the **exit** command. The following is displayed:

```
-> exit
Connection to 11.133.30.135 closed.
```

This display indicates the Secure Shell FTP session with IP address 11.133.20.135 is closed. The user is now logged into the OmniSwitch as a local device with no active remote connection.

Note. Establishing and closing the Secure Shell FTPv6 connection is similar to that of the Secure Shell FTP connection.

Modifying the Login Banner

The Login Banner feature allows you to change the banner that displays whenever someone logs into the switch. This feature can be used to display messages about user authorization and security. You can display the same banner for all login sessions or you can implement different banners for different login sessions. You can display a different banner for logins initiated by FTP sessions than for logins initiated by a direct console or a Telnet connection. The default login message looks similar to the following:

```
login : user123
password :

Welcome to the Alcatel-Lucent OmniSwitch 6450
Software Version 6.7.1.20.R02 Development, March 21, 2016.

Copyright(c), ALE USA Inc., 2016. All Rights reserved.

OmniSwitch(TM) is a trademark of Alcatel-Lucent Enterprise registered
in the United States Patent and Trademark Office.
```

Here is an example of a banner that has been changed:

```
login : user123
password :

Welcome to the Alcatel-Lucent OmniSwitch 6450
Software Version 6.7.1.20.R02 Development, March 21, 2016.

Copyright(c), ALE USA Inc., 2016. All Rights reserved.

OmniSwitch(TM) is a trademark of Alcatel-Lucent Enterprise registered
in the United States Patent and Trademark Office.

***** LOGIN ALERT *****
This switch is a secure device. Unauthorized
use of this switch will go on your permanent record.
```

Two steps are required to change the login banner. These steps are listed here:

- Create a text file that contains the banner you want to display in the switch's **/flash/switch** directory.
- Enable the text file by entering the **session banner** CLI command followed by the filename.

To create the text file containing the banner text, you may use the **vi** text editor in the switch. (See [Chapter 1, "Managing System Files,"](#) for information about creating files directly on the switch.) This method allows you to create the file in the **/flash** directory without leaving the CLI console session. You can also create the text file using a text editing software package (such as MS Wordpad) and transfer the file to the switch's **/flash** directory. For more information about file transfers, see [Chapter 1, "Managing System Files,"](#)

If you want the login banner in the text file to apply to FTP switch sessions, execute the following CLI command where the text filename is **firstbanner.txt**.

```
-> session banner ftp /flash/firstbanner.txt
```

If you want the login banner in the text file to apply to CLI switch sessions, execute the following CLI command where the text filename is **secondbanner.txt**.

```
-> session banner cli /flash/secondbanner.txt
```

If you want the login banner in the text file to apply to HTTP switch sessions, execute the following CLI command where the text filename is **thirdbanner.txt**.

```
-> session banner http /flash/thirdbanner.txt
```

The banner files must contain only ASCII characters and should bear the **.txt** extension. The switch does not reproduce graphics or formatting contained in the file.

Modifying the Text Display Before Login

By default, the switch does not display any text before the login prompt for any CLI session.

At initial bootup, the switch creates a **pre_banner.txt** file in the **/flash** directory. The file is empty and may be edited to include text that you want to display before the login prompt.

For example:

```
Please supply your user name and password at the prompts.
```

```
login : user123  
password :
```

In this example, the **pre_banner.txt** file has been modified with a text editor to include the **Please supply your user name and password at the prompts** message.

The pre-banner text cannot be configured for FTP sessions.

To remove a text display before the login prompt, delete the **pre_banner.txt** file (it is recreated at the next bootup and will be empty), or modify the **pre_banner.txt** file.

Configuring Login Parameters

You can set the number of times a user may attempt unsuccessfully to log in to the switch's CLI by using the **session login-attempt** command as follows:

```
-> session login-attempt 5
```

In this example, the user may attempt to log in to the CLI five (5) times unsuccessfully. If the user attempts to log in the sixth time, the switch will break the TCP connection.

You may also set the length of time allowed for a successful login by using the **session login-timeout** command as follows:

```
-> session login-timeout 20
```

In this example, the user must complete the login process within 20 seconds. This means that the time between a user entering a login name and the switch processing a valid password must not exceed 20 seconds. If the time-out period exceeds, the switch will break the TCP connection.

Configuring the Inactivity Timer

You can set the amount of time that a user must be inactive before the session times out. By default, the time-out for each session type is 4 minutes. To change the setting, enter the **session timeout** command with the type of session (**cli**, **http**, or **ftp**) and the desired number of minutes. In the following example, the CLI time-out is changed from the default to 8 minutes.

```
-> session timeout cli 8
```

This command changes the inactivity timer for new CLI sessions to 8 minutes. *Current CLI sessions are not affected.* In this example, current CLI sessions will be timed out after 4 minutes. (CLI sessions are initiated through Telnet, Secure Shell, or through the switch console port.)

For information about connecting to the CLI through Telnet or Secure Shell, see [“Using Telnet” on page 2-8](#) and [“Using Secure Shell” on page 2-12](#). For information about connecting to the CLI through the console port, see your *Getting Started Guide*. For information about using the CLI in general, see [Chapter 6, “Using the CLI.”](#)

The **ftp** option sets the time-out for FTP sessions. For example, to change the FTP time-out to 5 minutes, enter the following command:

```
-> session timeout ftp 5
```

This command changes the time-out for new FTP sessions to 5 minutes. Current FTP sessions are not affected. For more information about FTP sessions, see [“Using FTP” on page 2-10](#).

The **http** option sets the time-out for WebView sessions. For example, to change the WebView inactivity timer to 10 minutes, enter the following command:

```
-> session timeout http 10
```

In this example, any new WebView session will have a time-out of 10 minutes. Current WebView sessions are not affected. For more information about WebView sessions, see [Chapter 11, “Using WebView.”](#)

Enabling the DNS Resolver

A Domain Name System (DNS) resolver is an optional internet service that translates host names into IP addresses. Every time you enter a host name when logging into the switch, a DNS service must look up the name on a server and resolve the name to an IP address. You can configure up to three IPv4 domain name servers and three IPv6 domain name servers that is queried in turn to resolve the host name. If all servers are queried and none can resolve the host name to an IP address, the DNS fails. If the DNS fails, you must either enter an IP or IPv6 address in place of the host name or specify the necessary lookup tables on one of the specified servers.

Note. You do not need to enable the DNS resolver service unless you want to communicate with the switch by using a host name. If you use an IP or IPv6 address rather than a host name, the DNS resolver service is not needed.

You must perform three steps on the switch to enable the DNS resolver service.

- 1 Set the default domain name for DNS lookups with the **ip domain-name** CLI command.

```
-> ip domain-name mycompany1.com
```

- 2 Use the **ip domain-lookup** CLI command to enable the DNS resolver service.

```
-> ip domain-lookup
```

You can disable the DNS resolver by using the **no ip domain-lookup** command. For more information, refer to the *OmniSwitch AOS Release 6 CLI Reference Guide*.

- 3 Specify the IP addresses of up to three servers with the **ip name-server** CLI command. These servers will be queried when a host lookup is requested.

```
-> ip name-server 189.202.191.14 189.202.191.15 189.255.19.1
```

You can also specify IPv6 DNS servers to query on a host lookup. The following example describes the steps to enable the IPv6 DNS resolver service on the switch.

- 1 Set the default domain name for IPv6 DNS lookups with the **ip domain-name** CLI command.

```
-> ip domain-name mycompany1.com
```

- 2 Use the **ip domain-lookup** CLI command to enable the IPv6 DNS resolver service.

```
-> ip domain-lookup
```

You can disable the IPv6 DNS resolver by using the **no** form of the **ip domain-lookup** command. For more information, refer to the *OmniSwitch AOS Release 6 CLI Reference Guide*.

- 3 Specify the IPv6 addresses of up to three servers with the **ipv6 name-server** CLI command. These IPv6 servers will be queried when a host lookup is requested.

```
-> ipv6 name-server fe2d::2c f302::3de1:1 f1bc::202:fd40:f3
```

Note. You cannot use multicast, loopback, link-local and unspecified IPv6 addresses for specifying IPv6 DNS servers.

Verifying Login Settings

To display information about login sessions, use the following CLI commands:

who	Displays all active login sessions (for example, console, Telnet, FTP, HTTP, Secure Shell, Secure Shell FTP).
whoami	Displays the current user session.
show session config	Displays session configuration information (for example, default prompt, banner file name, inactivity timer, login timer, login attempts).
show dns	Displays the current DNS resolver configuration and status.

For more information about these commands, refer to the *OmniSwitch AOS Release 6 CLI Reference Guide*.

3 Using SNMP and OpenFlow

The Simple Network Management Protocol (SNMP) is an application-layer protocol that allows communication between SNMP managers and SNMP agents on an IPv4 as well as on an IPv6 network. Network administrators use SNMP to monitor network performance and to manage network resources.

OpenFlow is a communications interface defined between the control and forwarding layers that is used in a Software Defined Network (SDN). OpenFlow separates the control plane and the data plane in the switch. Traditionally, switches and routers have made decisions on where packets should travel based on rules local to the device.

In This Chapter

This chapter describes SNMP and OpenFlow and how to use them through the Command Line Interface (CLI). CLI commands are used in the configuration examples; for more details about the syntax of commands, see the *OmniSwitch AOS Release 6 CLI Reference Guide*.

Configuration procedures described in this chapter include:

- [“Setting Up An SNMP Management Station”](#) on page 3-4
- [“Setting Up Trap Filters”](#) on page 3-5
- [“Using SNMP For Switch Security”](#) on page 3-10
- [“Working with SNMP Traps”](#) on page 3-14
- [“OpenFlow Specifications”](#) on page 3-27
- [“Quick Steps to Configure OpenFlow Agent”](#) on page 3-30
- [“Verifying OpenFlow Configuration”](#) on page 3-31

This chapter also includes lists of Industry Standard and Enterprise (Proprietary) MIBs used to manage the OmniSwitch.

SNMP Specifications

The following table lists specifications for the SNMP protocol.

RFCs Supported for SNMPv2	1902 through 1907 - SNMPv2c Management Framework 1908 - Coexistence and transitions relating to SNMPv1 and SNMPv2c
RFCs Supported for SNMPv3	2570 – Version 3 of the Internet Standard Network Management Framework 2571 – Architecture for Describing SNMP Management Frameworks 2572 – Message Processing and Dispatching for SNMP 2573 – SNMPv3 Applications 2574 – User-based Security Model (USM) for version 3 SNMP 2575 – View-based Access Control Model (VACM) for SNMP 2576 – Coexistence between SNMP versions
Platforms Supported	OmniSwitch 6350, 6450
SNMPv1, SNMPv2, SNMPv3	The SNMPv3 protocol is ascending compatible with SNMPv1 and v2 and supports all the SNMPv1 and SNMPv2 PDUs
SNMPv1 and SNMPv2 Authentication	Community Strings
SNMPv1, SNMPv2 Encryption	None
SNMPv1 and SNMPv2 Security requests accepted by the switch	Sets and Gets
SNMPv3 Authentication	SHA, MD5
SNMPv3 Encryption	DES
SNMPv3 Security requests accepted by the switch.	Non-authenticated Sets, Non-authenticated Gets and Get-Nexts, Authenticated Sets, Authenticated Gets and Get-Nexts, Encrypted Sets, Encrypted Gets and Get-Nexts
SNMP traps	Refer to the table on page 3-10 for a complete list of traps and their definitions.
Maximum number of SNMP sessions that can be established on an OmniSwitch.	50

SNMP Defaults

The following table describes the default values of the SNMP protocol parameters.

Parameter Description	Command	Default Value/Comments
SNMP Management Station	snmp station	UDP port 162, SNMPv3, Enabled
Community Strings	snmp community map	Enabled
SNMP Security setting	snmp security	Privacy all (highest) security
Trap filtering	snmp trap filter	Disabled
Trap Absorption	snmp trap absorption	Enabled
Enables the forwarding of traps to WebView.	snmp trap to webview	Enabled
Enables or disables SNMP authentication failure trap forwarding.	snmp authentication trap	Disabled

Quick Steps for Setting Up An SNMP Management Station

An SNMP Network Management Station (NMS) is a workstation configured to receive SNMP traps from the switch. To set up an SNMP NMS by using the switch's CLI, proceed as follows:

- 1 Specify the user account name and the authentication type for that user. For example:

```
-> user NMSuserV3MD5DES md5+des password *****
```

- 2 Specify the UDP destination port number (in this case 8010), the IP address of the management station (199.199.100.200), a user account name (NMSuserV3MD5DES), and the SNMP version number (v3). For example:

```
-> snmp station 199.199.100.200 8010 NMSuserV3MD5DES v3 enable
```

Use the same command as above for specifying the IPv6 address of the management station. For example:

```
-> snmp station 300::1 enable
```

Note. *Optional.* To verify the SNMP Management Station, enter the **show snmp station** command. The display is similar to the one shown here:

```
-> show snmp station
ipAddress/udpPort      status  protocol user
-----+-----+-----
199.199.100.200/8010   enable  v3      NMSuserV3MD5DES
199.199.101.201/111   disable v2      NMSuserV3MD5
199.199.102.202/8002   enable  v1      NMSuserV3SHADES

-> show snmp station
ipAddress/udpPort      status  protocol user
-----+-----+-----
172.21.160.32/4000     enable  v3      abc
172.21.160.12/5000     enable  v3      user1
0300:0000:0000:0000:0211:d8ff:fe47:470b/4001  enable  v3      user2
0300:0000:0000:0000:0211:d8ff:fe47:470c/5001  enable  v2      abc
```

For more information about this display, see the “SNMP Commands” chapter in the *OmniSwitch AOS Release 6 CLI Reference Guide*.

Quick Steps for Setting Up Trap Filters

You can filter traps by limiting user access to trap command families. You can also filter according to individual traps.

Filtering by Trap Families

The following example creates a new user account. This account is granted read-only privileges to three CLI command families (snmp, chassis, and interface). Read-only privileges is withheld from all other command families.

- 1 Set up a user account named “usermark2” by executing the **user** CLI command.

```
-> user usermark2 password *****
```

- 2 Remove all read-only privileges from the user account.

```
-> user usermark2 read-only none
```

- 3 Add read-only privileges for the snmp, chassis, and interface command families.

```
-> user usermark2 read-only snmp chassis interface
```

Note. *Optional.* To verify the user account, enter the **show user** command. A partial display is shown here:

```
-> show user
User name = usermark2
Read right      = 0x0000a200 0x00000000,
Write right     = 0x00000000 0x00000000,
Read for domains = ,
Read for families = snmp chassis interface ,
Write for domains = None ,
Snmp authentication = NONE, Snmp encryption = NONE
```

The usermark2 account has read-only privileges for the snmp, chassis, and interface command families.

- 4 Set up an SNMP station with the user account “usermark2” defined above.

```
-> snmp station 210.1.2.1 usermark2 v3 enable
```

Note. *Optional.* To verify the SNMP Management Station, enter the **show snmp station** command. The display is similar to the one shown here:

```
-> show snmp station
ipAddress/udpPort      status  protocol  user
-----+-----+-----+-----
210.1.2.1/162         enable  v3        usermark2
```

The usermark2 account is established on the SNMP station at IP address 210.1.2.1.

Filtering by Individual Traps

The following example enables trap filtering for the coldstart, warmstart, linkup, and linkdown traps. The identification numbers for these traps are 0, 1, 2, and 3. When trap filtering is enabled, these traps are filtered. This means that the switch does *not* pass them through to the SNMP management station. All other traps are passed through.

- 1 Specify the IP address for the SNMP management station and the trap identification numbers.

```
-> show snmp trap filter 210.1.2.1 0 1 2 3
-> snmp trap filter 300::1 1 3 4
```

Note. *Optional.* You can verify which traps will *not* pass through the filter by entering the [snmp trap filter](#) command. The display is similar to the one shown here:

```
-> show snmp trap filter
ipAddress      trapId list
-----+-----
210.1.2.1      0  1  2  3
```

The SNMP management station with the IP address of 210.1.2.1 will *not* receive trap numbers 0, 1, 2, and 3.

For trap numbers refer to the [“Using SNMP For Switch Security”](#) on page 3-10. For more information on the CLI commands and the displays in these examples, refer to the *OmniSwitch AOS Release 6 CLI Reference Guide*.

SNMP Overview

SNMP provides an industry standard communications model used by network administrators to manage and monitor their network devices. The SNMP model defines two components, the SNMP Manager and the SNMP Agent.

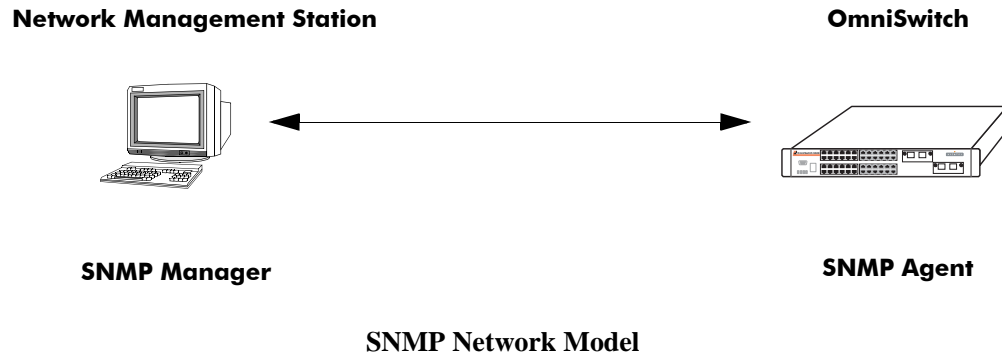

- The *SNMP Manager* resides on a workstation hosting the management application. It can query agents by using SNMP operations. An SNMP manager is commonly called a Network Management System (NMS). NMS refers to a system made up of a network device (such as a workstation) and the NMS software. It provides an interface that allows users to request data or see alarms resulting from traps or informs. It can also store data that can be used for network analysis.
- The *SNMP Agent* is the software entity that resides within the switch on the network. It maintains the management data about a particular network device and reports this data, as needed, to the managing systems. The agent also responds to requests for data from the SNMP Manager.

Along with the SNMP agent, the switch also contains *Management Information Bases (MIBs)*. MIBs are databases of managed objects, written in the SNMP module language, which can be monitored by the NMS. The SNMP agent contains MIB variables, which have values the NMS can request or change using Get, GetNext, GetBulk, or Set operations. The agent can also send unsolicited messages (traps or informs) to the NMS to notify the manager of network conditions.

SNMP Operations

Devices on the network are managed through transactions between the NMS and the SNMP agent residing on the network device (that is, switch). SNMP provides two kinds of management transactions, manager-request/agent-response and unsolicited notifications (traps or informs) from the agent to the manager.

In a manager-request/agent-response transaction, the SNMP manager sends a request packet, referred to as a Protocol Data Unit (PDU), to the SNMP agent in the switch. The SNMP agent complies with the request and sends a response PDU to the manager. The types of management requests are Get, GetNext, and GetBulk requests. These transactions are used to request information from the switch (Get, GetNext, or GetBulk) or to change the value of an object instance on the switch (Set).

In an unsolicited notification, the SNMP agent in the switch sends a trap PDU to the SNMP manager to inform it that an event has occurred. The SNMP manager normally does not send confirmation to the agent acknowledging receipt of a trap.

Using SNMP for Switch Management

The Alcatel-Lucent switch can be configured using the Command Line Interface (CLI), SNMP, or the WebView device management tool. When configuring the switch by using SNMP, an NMS application (such as [Alcatel-Lucent's OmniVista](#) or HP OpenView) is used.

Although MIB browsers vary depending on which software package is used, they all have a few things in common. The browser must compile the Alcatel-Lucent switch MIBs before it can be used to manage the switch by issuing requests and reading statistics. Each MIB must be checked for dependencies and the MIBs must be compiled in the proper order. Once the browser is properly installed and the MIBs are compiled, the browser software can be used to manage the switch. The MIB browser you use depends on the design and management requirements of your network.

Detailed information on working with MIB browsers is beyond the scope of this manual. However, you must know the configuration requirements of your MIB browser or other NMS installation before you can define the system to the switch as an SNMP station.

Setting Up an SNMP Management Station

An SNMP management station is a workstation configured to receive SNMP traps from the switch. You must identify this station to the switch by using the `snmp station` CLI command.

The following information is needed to define an SNMP management station.

- The IP address of the SNMP management station device.
- The UDP destination port number on the management station. This identifies the port to which the switch sends traps.
- The SNMP version used by the switch to send traps.
- A user account name that the management station recognizes.

Procedures for configuring a management station can be found in [“Quick Steps for Setting Up An SNMP Management Station” on page 3-4](#)

SNMP Versions

The SNMP agent in the switch can communicate with multiple managers. You can configure the switch to communicate with different management stations by using different versions of SNMP. The switch supports three versions of SNMP—v1, v2, and v3.

SNMPv1

SNMPv1 is the original implementation of the SNMP protocol and network management model. It is characterized by the Get, Set, GetNext, and Trap protocol operations.

SNMPv1 uses a rudimentary security system where each PDU contains information called a *community string*. The community string acts like a combination username and password. When you configure a device for SNMP management you normally specify one community string that provides read-write access to objects within the device and another community string that limits access to read-only. If the community string in a data unit matches one of these strings, the request is granted. If not, the request is denied.

The community string security standard offers minimal security and is generally insufficient for networks where the need for security is high. Although SNMPv1 lacks bulk message retrieval capabilities and security features, it is widely used and is a de facto standard in the Internet environment.

SNMPv2

SNMPv2 is a later version of the SNMP protocol. It uses the same Get, Set, GetNext, and Trap operations as SNMPv1 and supports the same community-based security standard. SNMPv1 is incompatible with SNMPv2 in certain applications due to the following enhancements:

- Management Information Structure

SNMPv2 includes new macros for defining object groups, traps compliance characteristics, and capability characteristics.

- Protocol Operations

SNMPv2 has two new PDUs not supported by SNMPv1. The GetBulkRequest PDU enables the manager to retrieve large blocks of data efficiently. In particular, it is well suited to retrieving multiple rows in a table. The InformRequest PDU enables one manager to send trap information to another manager.

SNMPv3

SNMPv3 supports the View-Based Access Control Model (VACM) and User-Based Security Model (USM) security models along with these added security features:

- Message integrity—Ensuring that a packet has not been tampered with in transit.
- Time Frame Protection—Limiting requests to specified time frames. The user can specify a time frame so that any PDU bearing an out of date timestamp is ignored.
- Encryption—Scrambling the contents of a packet to prevent it from being learned by an unauthorized source.
- Authentication—Determining that the message is from a valid source holding the correct privileges.

Using SNMP For Switch Security

Community Strings (SNMPv1 and SNMPv2)

The switch supports the SNMPv1 and SNMPv2c community strings security standard. When a community string is carried over an incoming SNMP request, the community string must match up with a user account name as listed in the community string database on the switch. Otherwise, the SNMP request is not processed by the SNMP agent in the switch.

Configuring Community Strings

To use SNMPv1 and v2 community strings, each user account name must be mapped to an SNMP community string. Follow these steps:

- 1 Create a user account on the switch and define its password. Enter the following CLI syntax to create the account “community_user1”.

```
-> user community_user1 password ***** no auth read-only all
```

Note. A community string inherits the security privileges of the user account that creates it.

A user account can be created locally on the switch by using CLI commands. For detailed information on setting up user accounts, refer to the “Using Switch Security” chapter of this manual.

- 2 Map the user account to a community string.

A community string works like a password so it is defined by the user. It can be any text string up to 32 characters in length. If spaces are part of the text, the string must be enclosed in quotation marks (“ ”). The following CLI command maps the username “community_user1” to the community string “comstring2”.

```
-> snmp community map comstring2 user community_user1 enable
```

- 3 Verify that the community string mapping mode is enabled.

By default, the community strings database is enabled. (If community string mapping is not enabled, the community string configuration is not checked by the switch.) If the community string mapping mode is disabled, use the following command to enable it.

```
-> snmp community map mode enable
```

Note. *Optional.* To verify that the community string is properly mapped to the username, enter the **show snmp community map** command. The display is similar to the one shown here:

```
->show snmp community map
Community mode : enabled

status  community string                                user name
-----+-----+-----+-----+-----
enabled comstring2                                     community_user1
```

This display also verifies that the community map mode is enabled.

Encryption and Authentication (SNMPv3)

Two important processes are used to verify that the message contents have not been altered and that the source of the message is authentic. These processes are *encryption* and *authentication*.

A typical data *encryption process* requires an encryption algorithm on both ends of the transmission and a secret key (like a code or a password). The sending device encrypts or “scrambles” the message by running it through an encryption algorithm along with the key. The message is then transmitted over the network in its encrypted state. The receiving device then takes the transmitted message and “un-scrambles” it by running it through a decryption algorithm. The receiving device cannot un-scramble the coded message without the key.

The switch uses the Data Encryption Standard (DES) encryption scheme in its SNMPv3 implementation. For DES, the data is encrypted in 64-bit blocks by using a 56-bit key. The algorithm transforms a 64-bit input into a 64-bit output. The same steps with the same key are used to reverse the encryption.

The *authentication process* ensures that the switch receives accurate messages from authorized sources. Authentication is accomplished between the switch and the SNMP management station through the use of a username and password identified via the [snmp station](#) CLI syntax. The username and password are used by the SNMP management station along with an authentication algorithm (SHA or MD5) to compute a hash that is transmitted in the PDU. The switch receives the PDU and computes the hash to verify that the management station knows the password. The switch also verifies the checksum contained in the PDU.

Authentication and encryption are combined when the PDU is first authenticated by either the SHA or MD5 method. Then the message is encrypted using the DES encryption scheme. The encryption key is derived from the authentication key, which is used to decrypt the PDU on the switch’s side.

Configuring Encryption and Authentication

Setting Authentication for a User Account

User account names and passwords must be a minimum of 8 characters in length when authentication and encryption are used. SNMP authentication types SHA and MD5 are available with DES and AES encryption. Specify the required authentication algorithm and the encryption standard to be used for authenticating and encrypting in the command syntax.

The following syntax sets authentication type MD5 with DES encryption for user account “user_auth1”.

```
-> user user_auth1 password pass1pass1 md5+des
```

Note. *Optional.* To verify the authentication and encryption type for the user, enter the [show user](#) command. The following is a partial display.

```
-> show user
User name = user_auth1,
Password expiration      = None,
Password allow to be modified date    = None,
Account lockout         = None,
Password bad attempts   = 0,
Read Only for domains   = None,
Read/Write for domains  = None,
Snmpp allowed          = YES,
Snmpp authentication    = MD5,
Snmpp encryption       = DES,
Console-Only           = Disabled
```

The user's SNMP authentication is shown as MD5 and SNMP encryption is shown as DES.

Separate Auth Key and Encryption Key for SNMPv3 User Access

The switch supports SNMPv3 users with both hashing and encryption such as SHA+DES, MD5+DES, or SHA+AES. Two different passwords are supported for a separate Auth Key and Priv Key using the **priv-password** parameter, for example:

```
-> user snmpv3user password pass1pass1 priv-password priv1priv1 read-write all
sha+aes
```

The privacy password can be entered in a masked format rather than as clear text format. While creating a user, **prompt-priv-passwd** option can be used with the 'user' command to configure the privacy password for the user. When this option is selected, a password prompt appears and the password can be provided. Password needs to be re-entered, and only if both the passwords match, command is accepted.

Password provided in this mode is not displayed on the CLI as text.

For example,

```
-> user snmpv3user password pass1pass1 prompt-priv-passwd
Enter privacy password:  *****
Re-enter privacy password: *****
```

Setting SNMP Security

By default, the switch is set to “privacy all”, which means the switch accepts only authenticated and encrypted v3 Sets, Gets, and Get-Nexts. You can configure different levels of SNMP security by entering **snmp security** followed by the command parameter for the desired security level. For example, the following syntax sets the SNMP security level as “authentication all” as defined in the table below:

```
-> snmp security authentication all
```

The command parameters shown in the following table define security from the lowest level (no security) to the highest level (traps only) as shown.

Security Level	SNMP requests accepted by the switch
no security	All SNMP requests are accepted.
authentication set	SNMPv1, v2 Gets Non-authenticated v3 Gets and Get-Nexts Authenticated v3 Sets, Gets, and Get-Nexts Encrypted v3 Sets, Gets, and Get-Nexts
authentication all	Authenticated v3 Sets, Gets, and Get-Nexts Encrypted v3 Sets, Gets, and Get-Nexts
privacy set	Authenticated v3 Gets and Get-Nexts Encrypted v3 Sets, Gets, and Get-Nexts
privacy all	Encrypted v3 Sets, Gets, and Get-Nexts
traps only	All SNMP requests are rejected.

Working with SNMP Traps

The SNMP agent in the switch has the ability to send traps to the management station. It is not required that the management station request them. Traps are messages alerting the SNMP manager to a condition on the network. A trap message is sent through a PDU issued from the switch's network management agent. It is sent to alert the management station to some event or condition on the switch.

Traps can indicate improper user authentication, restarts, the loss of a connection, or other significant events. You can configure the switch so that traps are forwarded to or suppressed from transmission to the management station under different circumstances. A trap informs the management station when the switch configuration is saved using CLI/SNMP/WEB.

Trap Filtering

You can filter SNMP traps in at least two ways. You can filter traps by limiting user access to trap families or you can filter according to individual traps.

Filtering by Trap Families

Access to SNMP traps can be restricted by withholding access privileges for user accounts to certain command families or domains. (Designation of particular command families for user access is sometimes referred to as *partition management*.)

SNMP traps are divided into functional families as shown in the [“Using SNMP For Switch Security” on page 3-10](#). These families correspond to switch CLI command families. When read-only privileges for a user account are restricted for a command family, that user account is also restricted from reading traps associated with that family.

Procedures for filtering traps according to command families can be found in the Quick Steps for [“Filtering by Trap Families” on page 3-5](#). For a list of trap names, command families, and their descriptions refer to the [“Using SNMP For Switch Security” on page 3-10](#).

Filtering By Individual Trap

You can configure the switch to filter out individual traps by using the **snmp trap filter** command. This command allows you to suppress specified traps from the management station. The following information is needed to suppress specific traps:

- The IP address of the SNMP management station that will receive the traps.
- The ID number of the individual traps to be suppressed.

Procedures for filtering individual traps can be found in the Quick Steps for [“Filtering by Individual Traps” on page 3-6](#). For a list of trap names, ID numbers, and their descriptions refer to the table [“Using SNMP For Switch Security” on page 3-10](#).

Authentication Trap

The authentication trap is sent when an SNMP authentication failure is detected. This trap is a signal to the management station that the switch received a message from an unauthorized protocol entity. This normally means that a network entity attempted an operation on the switch for which it had insufficient authorization. When the SNMP authentication trap is enabled, the switch forwards a trap to the management station. The following command enables the authentication trap:

```
-> snmp authentication trap enable
```

The trap is suppressed if the SNMP authentication trap is disabled.

Trap Management

Several CLI commands allow you to control trap forwarding from the agent in the switch to the SNMP management station.

Replaying Traps

The switch normally stores all traps that have been sent out to the SNMP management stations. You can list the last stored traps by using the **show snmp trap replay** command. This command lists the traps along with their sequence number. The sequence number is a record of the order in which the traps were previously sent out.

You can replay traps that have been stored on the switch for testing or troubleshooting purposes. This is useful in the event when any traps are lost in the network. To replay stored traps, use the **snmp trap replay** command followed by the IP address for an SNMP management station. This command replays (or re-sends) all stored traps from the switch to the specified management station on demand.

If you do not want to replay all of the stored traps, you can specify the sequence number from which the trap replay starts. The switch starts the replay with a trap sequence number greater than or equal to the sequence number given in the CLI command. The number of traps replayed depends on the number of traps stored for this station.

Absorbing Traps

The switch can send the same traps to the management station many, many times. You can suppress the transmission of identical repetitive traps by issuing the **snmp trap absorption** command. When trap absorption is enabled, traps that are identical to traps previously sent are suppressed and therefore not forwarded to the SNMP management station. The following command enables SNMP trap absorption:

```
-> snmp trap absorption enable
```

To view or verify the status of the Trap Absorption service, use the **show snmp trap config** command.

Sending Traps to WebView

When WebView forwarding is enabled, all traps sent by switch applications are also forwarded to WebView. The following command allows a WebView session to retrieve the trap history log:

```
-> snmp trap to webview enable
```

Checking Configuration File Using Traps

If there are any configuration changes, a trap is sent to Service Aware Manager (SAM) to enforce a poll when configuration file is saved. The running configuration is not saved in the configuration file (**boot.cfg**) until the user commits the changes using the **write memory** command or **copy running-config working** command. The configuration changes that are not committed are not detected by the switch until these commands are applied.

Related traps are raised on the following commands:

- write memory
- write memory flash-synchro
- copy running-config working

SNMP MIB Information

MIB Tables

You can display MIB tables and their corresponding command families by using the **show snmp mib family** command. The MIB table identifies the MIP identification number, the MIB table name and the command family. If a command family is not valid for the entire MIB table, the command family is displayed on a per-object basis.

For a list and description of system MIBs, refer to “[Industry Standard MIBs](#)” on page 3-18 and “[Enterprise \(Proprietary\) MIBs](#)” on page 3-22. For a list and description of traps, refer to the “[Using SNMP For Switch Security](#)” on page 3-10.

The following is a partial display.

```
-> show snmp mib family
MIP ID      MIB TABLE NAME                                FAMILY
-----+-----+-----+-----+-----+-----
6145      esmConfTrap                                    NO SNMP ACCESS
6146      alcetherStatsTable                            interface
6147      dot3ControlTable                             interface
6148      dot3PauseTable                               interface
6149      dot3StatsTable                               interface
6150      esmConfTable                                 interface
...
...
77828     healthModuleTable                             rmon
77829     healthPortTable                              rmon
77830     healthThreshInfo                             rmon
...
...
87042     vacmContextTable                             snmp
87043     vacmSecurityToGroupTable                     snmp
87044     vacmAccessTable                             snmp
87045     vacmViewTreeFamilyTable                     snmp
```

MIB Table Description

If the user account has no restrictions, the display shown by the **show snmp mib family** command can be very long. For documentation purposes, a partial list is shown above and three entry examples are defined.

- The first entry in the MIB Table shows an MIP identification number of 6145. The MIB table name is esmConfTrap. This table is found in the AlcatelIND1Port MIB, which defines managed objects for the ESM Driver subsystem.
- For MIP Id number 77828, the MIB table name is healthModuleTable. This table is found in the AlcatelIND1Health MIB, which defines managed objects for the health monitoring subsystem.
- For MIB Id number 87042, the MIB table name is vacmContextTable. This table is found in the SNMP-VIEW-BASED-ACM MIB, which serves as the view-based access control model (VACM) for the SNMP.

Industry Standard MIBs

The following table lists the supported industry standard MIBs.

MIB Name	Description	Dependencies
BRIDGE-MIB, RFC 1493	The Bridge MIB for managing MAC bridges based on the IEEE 802.1D standard between Local Area Network (LAN) segments.	SNMPv2-SMI, RFC1215-MIB
EE8023-LAG-MIB, IEEE 802.3ad	Link Aggregation module for managing IEEE Standard 802.3ad.	SNMPv2-SMI, SNMPv2-TC, SNMPv2-CONF, IF-MIB, Q-BRIDGE-MIB
ENTITY-MIB, RFC 2737	Entity MIB (Version 2). Standardized set of managed objects representing logical and physical entities and relationships between them.	SNMPv2-SMI, SNMPv2-TC, SNMPv2-CONF, SNMP- FRAMEWORK- MIB
EtherLike-MIB, RFC 2665	Definitions of Managed Objects for the Ethernet-like Interface Types.	SNMPv2-SMI, SNMPv2-CONF, IF-MIB
HCCNUM-TC, RFC 2856:	An MIB module containing textual conventions for high-capacity data types. This module addresses an immediate need for data types not directly supported in the SMIV2. This short-term solution is meant to be deprecated as a long-term solution is deployed.	SNMPv2-SMI, SNMPv2-TC
IANAifType-MIB	This MIB module defines the IANAifType Textual Convention, and thus the enumerated values of the ifType object defined in the MIB-II Table.	SNMPv2-SMI, SNMPv2-TC
IANA-RTPROTO-MIB	This MIB module defines the IANAipRouteProtocol and IANAipMRouteProtocol textual conventions for use in MIBs which need to identify unicast or multi-cast routing mechanisms.	SNMPv2-SMI, SNMPv2-TC
IEEE8021-PAE-MIB	This MIB modules defines 802.1X ports used for port-based access control.	SNMPv2-SMI, SNMPv2-TC, SNMPv2-CONF, SNMP- FRAMEWORK- MIB IF-MIB
IF-MIB, RFC 2863	The Interfaces Group MIB. Contains generic information about the physical interfaces of the entity.	SNMPv2-SMI, SNMPv2-TC, SNMPv2-CONF, SNMPv2-MIB, IANAifType-MIB

MIB Name	Description	Dependencies
IGMP-STD-MIB, RFC 2933	Internet Group Management Protocol MIB.	SNMPv2-SMI, SNMPv2-TC, SNMPv2-CONF, IF-MIB
INET-ADDRESS-MIB, RFC 2851	Textual Conventions for Internet Network Addresses.	SNMPv2-SMI, SNMPv2-TC
IP-BRIDGE-MIB, RFC 2674	The Bridge MIB Extension module for managing Priority and Multicast Filtering, defined by IEEE 802.1D.	SNMPv2-SMI, SNMPv2-TC, SNMPv2-CONF, BRIDGE-MIB
IP-FORWARD-MIB, RFC 2096	IP Forwarding Table MIB	SNMPv2-SMI, SNMPv2-TC, IP-MIB, SNMPv2-CONF
IP-MIB, RFC 2011	SNMPv2 Management Information Base for the Internet Protocol by using SMIv2. Includes Internet-work Control Message Protocol (ICMP).	SNMPv2-SMI, SNMPv2-TC, SNMPv2-CONF
IPv6-TC, RFC 2465	This MIB defines the management information for IPv6; Textual conventions and general group	SNMPv2-SMI, SNMPv2-TC
IPv6-ICMP-MIB, RFC 2466	Management Information base for IPv6 Group.	SNMPv2-SMI, SNMPv2-CONF, IPv6-MIB
IPv6-TCP-MIB, RFC 2452	Management Information Base for the Transmission Control Protocol.	SNMPv2-SMI, SNMPv2-TC, SNMPv2-CONF
IPv6-UDP-MIB, RFC 2454	Management Information Base for User Datagram Protocol	SNMPv2-SMI, SNMPv2-CONF, IPv6-TC
MAU-MIB, RFC 2668	Management Information for IEEE 802.3 Medium Attachment Units.	SNMPv2-SMI, SNMPv2-TC, SNMPv2-CONF
PIM-MIB, RFC 2934	Protocol Independent Multicast MIB for IPv4	SNMPv2-SMI, SNMPv2-TC, SNMPv2-CONF, IF-MIB, IPMROUTE-STD-MIB
Q-BRIDGE-MIB, RFC 2674	The Bridge MIB Extension module for managing Priority and Multicast Filtering, defined by IEEE 802.1D.	SNMPv2-SMI, SNMPv2-TC, SNMPv2-CONF, SNMP-FRAMEWORK-MIB, BRIDGE-MIB, P-BRIDGE-MIB

MIB Name	Description	Dependencies
RIPv2-MIB, RFC 1724	Routing Information Protocol (RIP) Version 2 MIB Extension.	SNMPv2-SMI, SNMPv2-TC, SNMPv2-CONF
RMON-MIB, RFC 2819	Remote Network Monitoring (RMON) Management Information Base.	SNMPv2-SMI, SNMPv2-TC, SNMPv2-CONF
RS-232-MIB, RFC 1659	Definitions of Managed Objects for RS-232-like Hardware Devices by using SMIv2.	SNMPv2-SMI, SNMPv2-CONF, IF-MIB
SNMP-COMMUNITY MIB, RFC 2576	This MIB module defines objects to help support coexistence between SNMPv1, SNMPv2c, and SNMPv3.	SNMPv2-SMI, SNMP-FRAME- WORK-MIB, SNMP-TARGET- MIB, SNMPv2-CONF
SNMP-FRAMEWORK MIB, RFC 2571	An Architecture for Describing SNMP Management Frameworks.	SNMPv2-SMI, SNMPv2-TC, SNMPv2-CONF
SNMP-MPD-MIB, RFC 2572	Message Processing And Dispatching For The Simple Network Management Protocol (SNMP).	SNMPv2-SMI, SNMPv2-CONF
SNMP-NOTIFICATION MIB, RFC 2573	SNMP Applications, Notifications SNMP Entity Remote Configuration.	SNMPv2-SMI, SNMPv2-TC, SNMPv2-CONF, SNMP- FRAMEWORK- MIB, SNMP-TARGET- MIB
SNMP-PROXY-MIB, RFC 2573	SNMP Applications, Proxy SNMP Entity Remote Configuration.	SNMPv2-SMI, SNMPv2-TC, SNMPv2-CONF, SNMP- FRAMEWORK- MIB, SNMP-TARGET MIB
SNMP-TARGET-MIB, RFC 2573	SNMP Applications, Proxy SNMP Entity Remote Configuration.	SNMPv2-SMI, SNMPv2-TC, SNMPv2-CONF, SNMP- FRAMEWORK- MIB

MIB Name	Description	Dependencies
SNMP-USER-BASED-SM-MIB, RFC 2574	User-based Security Model (USM) for version 3 of the Simple Network Management Protocol (SNMPv3).	SNMPv2-SMI, SNMPv2-TC, SNMPv2-CONF, SNMP-FRAMEWORK-MIB
SNMPv2-MIB, RFC 1907	Management Information Base for Version 2 of the Simple Network Management Protocol (SNMPv2).	SNMPv2-SMI, SNMPv2-TC, SNMPv2-CONF
SNMP-VIEW-BASED-ACM-MIB, RFC 2575	View-based Access Control Model (VACM) for the Simple Network Management Protocol (SNMP).	SNMPv2-SMI, SNMPv2-TC, SNMPv2-CONF, SNMP-FRAMEWORK-MIB
TCP-MIB, RFC 2012	SNMPv2 Management Information Base for the Transmission Control Protocol by using SMIv2.	SNMPv2-SMI, SNMPv2-CONF
TUNNEL-MIB, RFC 2667	IP Tunnel MIB	SNMPv2-SMI, SNMPv2-TC, SNMPv2-CONF, IF-MIB
UDP-MIB, RFC 2013	SNMPv2 Management Information Base for the User Datagram Protocol by using SMIv2.	SNMPv2-SMI, SNMPv2-CONF

Enterprise (Proprietary) MIBs

The following table lists the supported enterprise proprietary MIBs.

Note. The ALCATEL-IND1-BASE* MIB is required for *all* MIBs listed in this table.

MIB Name	Description	Dependencies*
ALCATEL-IND1-AAA-MIB	Definitions of managed objects for the Authentication, Authorization, and Accounting (AAA) subsystem.	SNMPv2-SMI, SNMPv2-TC, SNMP-v2-CONF
ALCATEL-IND1-BASE	This module provides base definitions for modules developed to manage Alcatel-Lucent Internetworking networking infrastructure products.	SNMPv2-SMI
ALCATEL-IND1-CHASSIS-MIB	Definitions of managed objects for the Chassis Management subsystem.	SNMPv2-SMI, SNMPv2-TC, SNMPv2-CONF, SNMP-FRAMEWORK-MIB, ENTITY-MIB
ALCATEL-IND1-CONFIG-MGR-MIB	Definitions of managed objects for the Configuration Manager subsystem.	SNMPv2-SMI, SNMPv2-TC, SNMPv2-CONF
ALCATEL-IND1-DEVICES	Definitions of chassis and modules.	SNMP-SMI
ALCATEL-IND1-DOT1Q-MIB	Definitions of managed objects for the IEEE 802.1Q subsystem.	SNMPv2-SMI, SNMPv2-TC, SNMPv2-CONF
ALCATEL-IND1-DOT1X-MIB	Definitions of managed objects for the IEEE 802.1X subsystem.	SNMPv2-SMI, SNMPv2-TC
ALCATEL-IND1-DRCTM-MIB	Definitions of managed objects for the Dynamic Routing and Control (DRC) subsystems.	SNMPv2-SMI, SNMPv2-CONF
ALCATEL-IND1-GROUP-MOBILITY-MIB	Definitions of managed objects for Group Mobility.	SNMPv2-TC, SNMPv2-SMI, SNMPv2-CONF
ALCATEL-IND1-HEALTH-MIB	Definitions of managed objects for the Health Monitoring subsystem.	SNMPv2-SMI, SNMPv2-CONF
ALCATEL-IND1-IGMP-MIB	Definitions of managed objects for the IPv4 Multicast MIB.	SNMPv2-TC, SNMPv2-SMI, SNMPv2-CONF, INET-ADDRESS-MIB, IF-MIB

MIB Name	Description	Dependencies*
ALCATEL-IND1-INTERSWITCH-PROTOCOL-MIB	Definitions of managed objects for the Interswitch Protocol (that is, GMAP, XMAP) subsystem.	SNMPv2-SMI, SNMPv2-TC, SNMPv2-CONF, IF-MIB
ALCATEL-IND1-IP-MIB	Definitions of managed objects for the IP Stack subsystem.	SNMPv2-SMI, SNMPv2-TC, SNMPv2-CONF, IP-MIB
ALCATEL-IND1-IPMRM-MIB	Definitions of managed objects for IP Multicast Route Manager (IPMRM) global configuration parameters	SNMPv2-SMI, SNMPv2-CONF
ALCATEL-IND1-IPMS-MIB	Definitions of managed objects for the IP Multicast Switching (IPMS) subsystem.	SNMPv2-SMI, SNMPv2-TC, SNMPv2-CONF, IF-MIB
ALCATEL-IND1-IPRM-MIB	Definitions of managed objects for the IP Routing Manager (IPRM) subsystem.	SNMPv2-SMI, SNMPv2-TC, SNMPv2-CONF, IANA-RTPROTO-MIB
ALCATEL-IND1-IPv6-MIB	Definitions of managed objects for the IPv6 subsystem.	SNMPv2-SMI, SNMPv2-TC, SNMPv2-CONF, IPv7-TC, IPv6-MIB
ALCATEL-IND1-LAG-MIB	Definitions of managed objects for the IEEE 802.3ad Link Aggregation (LAG) subsystem.	SNMPv2-SMI, SNMPv2-TC, SNMPv2-CONF, IEEE8023-LAG-MIB, IF-MIB, Q-BRIDGE-MIB
ALCATEL-IND1-LPS-MIB	Definitions of the MIB module for the address learning MIB addresses entity.	SNMPv2-SMI, SNMPv2-TC, IF-MIB, Q-BRIDGE-MIB, ALCATEL-IND1-SYSTEM-MIB, SNMPv2-CONF
ALCATEL-IND1-MAC-ADDRESS-MIB	Definitions of managed objects for the Source Learning MAC Address subsystem.	SNMPv2-SMI, SNMPv2-TC, SNMPv2-CONF, IF-MIB, Q-Bridge-MIB

MIB Name	Description	Dependencies*
ALCATEL-IND1-MAC-SERVER-MIB	Definitions of managed objects for the Chassis Supervision MAC Server subsystem.	SNMPv2-SMI, SNMPv2-TC, SNMPv2-CONF, ENTITY-MIB, ALCATEL-IND1-CHASSIS-MIB
ALCATEL-IND1-MLD-MIB	Definitions of the Multicast Listener Discovery (MLD) subsystem.	SNMPv2-SMI, SNMPv2-TC, SNMPv2-CONF, INET-ADDRESS-MIB, IF-MIB
ALCATEL-IND1-NTP-MIB	Definitions of the Network Time Protocol (NTP) subsystem.	SNMPv2-SMI, SNMPv2-TC
ALCATEL-IND1-PARTITIONED-MGR-MIB	Definitions of the user Partitioned Manager subsystem.	SNMPv2-SMI, SNMPv2-TC, SNMPv2-CONF, Q-BRIDGE-MIB, SNMP-FRAMEWORK-MIB, SNMPv2-TC
ALCATEL-IND1-PCAM-MIB	Definition of managed objects for the Coronado Layer3 Hardware Routing Engine (HRE).	SNMPv2-SMI, SNMPv2-TC, SNMPv2-CONF
ALCATEL-IND1-PIM-MIB	Definitions of managed objects for the Protocol Independent Multicast Sparse Mode (PIM-SM) and Protocol Independent Multicast Dense Mode (PIM-DM) subsystem.	SNMPv2-SMI, SNMPv2-TC, SNMPv2-CONF, ALCATEL-IND1-BASE
ALCATEL-IND1-POLICY-MIB	Definitions of managed objects for the Policy Manager subsystem.	SNMPv2-SMI, SNMPv2-TC, SNMPv2-CONF
ALCATEL-IND1-PORT-MIB	Definitions of managed objects for the Port Manager subsystem.	SNMPv2-SMI, SNMPv2-CONF, IF-MIB
ALCATEL-IND1-PORT-MIRRORING-MONITORING-MIB	Definitions of managed objects for the Port Mirroring and Monitoring subsystem.	SNMPv2-SMI, SNMPv2-TC, SNMPv2-CONF
ALCATEL-IND1-QOS-MIB	Definitions of managed objects for the Quality of Service (QoS) subsystem.	SNMPv2-SMI, SNMPv2-TC
ALCATEL-IND1-RDP-MIB	Definitions of managed objects for the Router Discovery Protocol (RDP) subsystem.	SNMPv2-SMI, SNMPv2-TC, SNMPv2-CONF

MIB Name	Description	Dependencies*
ALCATEL-IND1-RIP-MIB	Definitions of managed objects for the Routing Information Protocol (RIP) subsystem.	SNMPv2-SMI, SNMPv2-TC, SNMPv2-CONF
ALCATEL-IND1-RIPNG-MIB	Definitions of managed objects for the Routing Information Protocol (RIPng) subsystem.	SNMPv2-SMI, SNMPv2-TC, SNMPv2-CONF IPv6-TC
ALCATEL-IND1-SESSION-MGR-MIB	Definitions of managed objects for the User Session Manager subsystem.	SNMPv2-SMI, SNMPv2-TC, SNMPv2-CONF
ALCATEL-IND1-SNMP-AGENT-MIB	Definitions of managed objects for the Simple Network Management Protocol (SNMP) Agent subsystem.	SNMPv2-SMI, SNMPv2-TC, SNMPv2-CONF
ALCATEL-IND1-STACK-MANAGER	Definitions of the managed objects for Stack Manager Chassis, Stack Manager Statistics, and Stack Manager Traps.	SNMPv2-SMI, SNMPv2-TC, SNMPv2-CONF
ALCATEL-IND1-SYSTEM-MIB	Definitions of managed objects for the System Services subsystem.	SNMPv2-SMI, SNMPv2-TC, SNMPv2-CONF
ALCATEL-IND1-TP-DEVICES	Definitions of managed objects for the OmniAccess 4000.	SNMPv2-SMI, ALCATEL-IND1 BASE
ALCATEL-IND1-TRAP-MGR-MIB	Definitions of managed objects for the SNMP Notification (that is, Trap) Manager subsystem.	SNMPv2-SMI, SNMP-v2-TC, SNMPv2-CONF
ALCATEL-IND1-UDP-RELAY-MIB	Definitions of managed objects for the User Datagram Protocol (UDP) Relay subsystem.	SNMPv2-SMI, SNMPv2-CONF
ALCATEL-IND1-VLAN-MGR-MIB	Definitions of managed objects for the VLAN Manager subsystem.	SNMPv2-SMI, SNMPv2-TC, SNMPv2-CONF
ALCATEL-IND1-VLAN-STP-MIB	Definitions of managed objects for the VLAN Spanning Tree Protocol (STP) subsystem.	SNMPv2-SMI, SNMPv2-CONF, BRIDGE-MIB
ALCATEL-IND1-WEB-MGT-MIB	Definitions of managed objects for the Web Based Management subsystem.	SNMPv2-SMI, SNMPv2-TC, SNMPv2-CONF, INET-ADDRESS-MIB

Verifying the SNMP Configuration

To display information about SNMP management stations, trap management, community strings, and security, use the **show** commands listed in the following table.

show snmp station	Displays current SNMP station information including IP address, UDP Port number, Enabled/Disabled status, SNMP version, and user account names.
show snmp community map	Shows the local community strings database including status, community string text, and user account name.
show snmp security	Displays current SNMP security status.
show snmp statistics	Displays SNMP statistics. Each MIB object is listed along with its status.
show snmp mib family	Displays SNMP MIB information. Information includes MIB ID number, MIB table name, and command family.
show snmp trap replay	Displays SNMP trap replay information. This includes the IP address of the SNMP station manager that replayed each trap and the number of the oldest replayed trap.
show snmp trap filter	Displays the current SNMP trap filter status. This includes the IP address of the SNMP station that recorded the traps and the identification list for the traps being filtered.
show snmp authentication trap	Displays the current authentication failure trap forwarding status (that is, enable or disable).
show snmp trap config	Displays SNMP trap information including trap ID numbers, trap names, command families, and absorption rate. This command also displays the Enabled/Disabled status of SNMP absorption and the Traps to WebView service.

For more information about the resulting displays from these commands, see the *OmniSwitch AOS Release 6 CLI Reference Guide*.

OpenFlow Specifications

Platforms Supported	OmniSwitch 6450 (stack or standalone)
Modes Supported	Normal Hybrid (API)
Versions Supported	1.0 1.3.1
Maximum number of logical switches	3
Maximum number of controllers per logical switch	3
Maximum number of logical switches in Hybrid mode	1

OpenFlow Agent Overview

OpenFlow is a communications interface defined between the control and forwarding layers that is used in a Software Defined Network (SDN). OpenFlow essentially separates the control plane and the data plane in the switch. Traditionally, switches and routers have made decisions on where packets should travel based on rules local to the device. With OpenFlow, only the data plane exists on the switch itself, and all control decisions are communicated to the switch from a central Controller. If the device receives a packet for which it has no flow information, it sends the packet to the Controller for inspection, and the Controller determines where that packet should be sent based on QoS-type rules configured by the user (drop the packets to create a firewall, pass the packets to a specific port to perform load balancing, prioritize packets, etc).

The OmniSwitch can operate in AOS or OpenFlow mode, including a modified OpenFlow mode known as Hybrid mode. AOS will designate the ports managed/controlled by AOS or by OpenFlow on a per-port basis. By default, ports are managed/controlled by AOS.

The following are the key components available for OpenFlow support.

OpenFlow Logical Switch

An OpenFlow logical switch consists of a portion of the switch's resources that are managed by an OpenFlow Controller (or set of Controllers) via the OpenFlow Agent. Up to 3 logical switches can be configured on an OmniSwitch, with each switch supporting up to three controllers. A logical switch has a VLAN, physical ports, and/or link aggregate ports assigned to it. All packets received on these ports are forwarded directly to the Openflow agent. Spanning tree and source learning do not operate on OpenFlow assigned ports.

OpenFlow Normal Mode

In Normal mode, the logical switch operates as per the OpenFlow standards. In normal mode, on OpenFlow enabled ports, most AOS commands will be disabled except for some port specific commands such as those for link aggregation, UDLD, DDM,LLDP and QoS per port configuration.

OpenFlow Hybrid (API) Mode

In Hybrid mode, logical switch acts as an interface through which the Controller may insert flows. These flows are treated as QoS policy entries and offer the same functionality. A Hybrid logical switch operates on all ports, link aggregates, and VLANs not assigned to other OpenFlow logical switches. Only one logical switch can be configured in Hybrid mode.

Supported OpenFlow Parameters

The following OpenFlow tables, match fields, groups and actions are supported.

Flow Definitions:

- Exact Match
- Wildcard
- MAC Table

Match Fields:

- Ingress Port

- Ethernet Destination Address
- Ethernet Source Address
- VLAN Tag / VLAN Priority
- Ethernet Type
- IPv4 or IPv6 Protocol Number
- IPv4 Source Address / ARP Sender Protocol Address
- IPv4 Destination Address / ARP Target Protocol Address
- TCP / UDP Source & Destination Ports
- ICMP Type / Code
- ARP Operation Code

Group

Groups are a way of combining a set of activities into one action. For example, a Group could be used to represent an IP next hop with all of the associated activities (MAC change, VLAN update, and so on). The collection of actions is stored in a bucket. Each group includes a collection of buckets and the different types identify policies on how to select which bucket(s) to use.

- ALL - The actions of all buckets are executed. This will be used to implement broadcast or multicast activities. The packet is effectively cloned for each bucket; one packet is processed for each bucket of the group.
- INDIRECT - This is an ALL type group with a single bucket. Allows multiple flow entries or groups to point to a common group identifier, supporting faster, more efficient convergence (for example, next hops for IP forwarding). This group type is effectively identical to an all group with one bucket.

Note.

- Packet modification actions are supported by both ALL and INDIRECT group type.

- Groups are supported only in Openflow 1.3.1 version.

Actions Fields:

- Output - To physical, reserved or linkagg port
- Drop - Drop the packet
- Group - Process packets according to specified group
- Set Field - Set fields in the packet (only for single egress port). VLAN priority can only be set for tagged packets.
- Change-TTL - Modify the values of the IPv4 TTL
- Push VLAN – The VLAN header tag is pushed as the outer header. (**Note:** Every Push VLAN action must be followed by a Set VLAN action.)

Quick Steps to Configure OpenFlow Agent

Follow the steps in this section for a quick tutorial on how to configure an OpenFlow Agent on the OmniSwitch. A logical switch in Hybrid mode does not have a VLAN or interface configured.

1 Create the logical switch and configure the mode

```
-> openflow logical-switch vswitch1 mode normal version 1.3.1 vlan 5
-> openflow logical-switch vswitch2 mode api
```

2 Assign a controller to the logical switch

```
-> openflow logical-switch vswitch1 controller 1.1.1.1
-> openflow logical-switch vswitch2 controller 2.2.2.2
```

3 Assign interfaces to the logical switch

```
-> openflow logical-switch vswitch1 interfaces port 1/3
```

4 Verify the configuration

```
-> show openflow logical-switch
```

Logical Switch	Admin State	Mode	Versions	VLAN	Ctrlrs	Intf	Flows
vswitch1	Ena	Norm	1.3.1	5	1	1	5
vswitch2	Ena	API	1.0 1.3.1	N/A	1	56	0

```
-> show openflow logical-switch controllers
```

Logical Switch	Controller	Role	Admin State	Oper State
vswitch1	1.1.1.1:6633	Equal	Ena	Connect
vswitch2	2.2.2.2:6633	Equal	Ena	Backoff

```
-> show openflow logical-switch interfaces
```

Logical Switch	Interface	Mode
vswitch1	1/3	Norm
vswitch2	1/1	API
vswitch2	1/2	API
vswitch2	1/4	API
vswitch2	1/5	API
vswitch2	1/6	API
vswitch2	1/7	API

(output truncated)

Verifying OpenFlow Configuration

To display information about the Openflow configuration use the following show command:

show openflow	Displays global OpenFlow configuration.
show openflow logical-switch	Displays logical switch configuration.
show openflow logical-switch stats	Displays logical switch statistics.

4 Configuring Network Time Protocol (NTP)

Network Time Protocol (NTP) is used to synchronize the time of a computer client or server to another server or reference time source, such as a radio or satellite receiver. It provides client time accuracies within a millisecond on LANs, and up to a few tens of milliseconds on WANs relative to a primary server synchronized to Universal Coordinated Time (UTC) (through a Global Positioning Service receiver, for example).

In This Chapter

This chapter describes the basic components of the OmniSwitch implementation of Network Time Protocol and how to configure it through Command Line Interface (CLI). CLI commands are used in the configuration examples; for more details about the syntax of commands, see the *OmniSwitch AOS Release 6 CLI Reference Guide*.

Configuration procedures described in this chapter include:

- Enabling the NTP client and selecting the NTP mode. See [“Configuring the OmniSwitch as a Client” on page 4-9](#).
- Selecting an NTP server for the NTP client and modifying settings for communicating with the server. See [“NTP Servers” on page 4-10](#).
- Enabling authentication in NTP negotiations. See [“Using Authentication” on page 4-12](#).

NTP Specifications

RFCs supported	1305–Network Time Protocol
Platforms Supported	OmniSwitch 6350, 6450
Maximum number of NTP servers per client	12

NTP Defaults Table

The following table shows the default settings of the configurable NTP parameters:

NTP Defaults

Parameter Description	Command	Default Value/Comments
Specifies an NTP server from which this switch receives updates	ntp server	version: 4 minpoll: 6 prefer: no key: 0
Used to activate client	ntp client	disabled
Used to activate NTP client broadcast mode	ntp broadcast	disabled
Used to set the advertised broadcast delay, in microseconds	ntp broadcast-delay	4000 microseconds

NTP Quick Steps

The following steps are designed to show the user the necessary commands to set up NTP on an OmniSwitch:

- 1 Designate an NTP server for the switch using the **ntp server** command. The NTP server provides the switch with its NTP time information. For example:

```
-> ntp server 1.2.5.6
```

- 2 Activate the client side of NTP on the switch using the **ntp client** command. For example:

```
-> ntp client enable
```

- 3 You can check the server status using the **show ntp server status** command, as shown:

```
-> show ntp server status 198.206.181.139
IP address          = 198.206.181.139,
Host mode           = client,
Peer mode           = server,
Prefer              = no,
Version             = 4,
Key                 = 0,
Stratum             = 2,
Minpoll             = 6 (64 seconds),
Maxpoll             = 10 (1024 seconds),
Delay               = 0.016 seconds,
Offset              = -180.232 seconds,
Dispersion          = 7.945 seconds
Root distance       = 0.026,
Precision           = -14,
Reference IP        = 209.81.9.7,
Status              = configured : reachable : rejected,
Uptime count        = 1742 seconds,
Reachability        = 1,
Unreachable count   = 0,
Stats reset count   = 1680 seconds,
Packets sent        = 1,
Packets received    = 1,
Duplicate packets   = 0,
Bogus origin        = 0,
Bad authentication  = 0,
Bad dispersion      = 0,
Last Event          = peer changed to reachable,
```

- 4 You can check the list of servers associated with this client using the **show ntp client server-list** command, as shown:

```
-> show ntp client server-list
IP Address          Ver   Key   St   Delay      Offset      Disp
=====+=====+=====+=====+=====+=====+=====
1.2.5.6             4     0     2     0.06       -0.673      0.017
```

- 5 You can check the client configuration using the **show ntp client** command, as shown:

```
-> show ntp client
Current time:                THU SEP 15 2005 17:44:54 (UTC)
Last NTP update:            THU SEP 15 2005 17:30:54
Client mode:                 enabled
Broadcast client mode:      disabled
Broadcast delay (microseconds): 4000
```

NTP Overview

Network Time Protocol (NTP) is used to synchronize the time of a computer client or server to another server or reference time source, such as a radio or satellite receiver. It provides client time accuracies within a millisecond on LANs, and up to a few tens of milliseconds on WANs relative to a primary server synchronized to Universal Coordinated Time (UTC) (via a Global Positioning Service receiver, for example). Typical NTP configurations utilize multiple redundant servers and diverse network paths in order to achieve high accuracy and reliability. Some configurations include cryptographic authentication to prevent accidental or malicious protocol attacks.

It is important for networks to maintain accurate time synchronization between network nodes. The standard timescale used by most nations of the world is based on a combination of UTC (representing the Earth's rotation about its axis), and the Gregorian Calendar (representing the Earth's rotation about the Sun). The UTC timescale is disciplined with respect to International Atomic Time (TAI) by inserting leap seconds at intervals of about 18 months. UTC time is disseminated by various means, including radio and satellite navigation systems, telephone modems, and portable clocks.

Special purpose receivers are available for many time-dissemination services, including the Global Position System (GPS) and other services operated by various national governments. For reasons of cost and convenience, it is not possible to equip every computer with one of these receivers. However, it is possible to equip some computers with these clocks, which then act as primary time servers to synchronize a much larger number of secondary servers and clients connected by a common network. In order to do this, a distributed network clock synchronization protocol is required which can read a server clock, transmit the reading to one or more clients, and adjust each client clock as required. Protocols that do this include NTP.

Note. The OmniSwitch can only be an NTP client in an NTP network. It cannot act as an NTP server.

Stratum

Stratum is the term used to define the relative proximity of a node in a network to a time source (such as a radio clock). Stratum 1 is the server connected to the time source itself. (In most cases the time source and the stratum 1 server are in the same physical location.) An NTP client or server connected to a stratum 1 source would be stratum 2. A client or server connected to a stratum 2 machine would be stratum 3, and so on, as demonstrated in the diagram below:

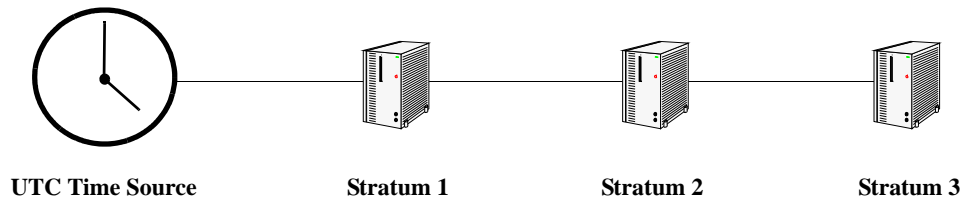

The farther away from stratum 1 a device is, the more likely there will be discrepancies or errors in the time adjustments done by NTP. A list of stratum 1 and 2 sources available to the public can be found on the Internet.

Note. It is not required that NTP be connected to an officially recognized time source (for example, a radio clock). NTP can use any time source to synchronize time in the network.

Using NTP in a Network

NTP operates on the premise that there is one true standard time (defined by UTC), and that if several servers claiming synchronization to the standard time are in disagreement, then one or more of them must be out of synchronization or not functioning correctly. The stratum gradation is used to qualify the accuracy of a time source along with other factors, such as advertised precision and the length of the network path between connections. NTP operates with a basic distrust of time information sent from other network entities, and is most effective when multiple NTP time sources are integrated together for checks and crosschecks. To achieve this end, there are several modes of operation that an NTP entity can use when synchronizing time in a network. These modes help predict how the entity behaves when requesting or sending time information, listed below:

- A switch can be a client of an NTP server (usually of a lower stratum), receiving time information from the server but not passing it on to other switches.
- A switch can be a client of an NTP server, and in turn be a server to another switch or switches.
- A switch (regardless of its status as either a client or server) must be peered with another switch. Peering allows NTP entities in the network of the same stratum to regard each other as reliable sources of time and exchange time information.

Examples of these are shown in the simple network diagram below:

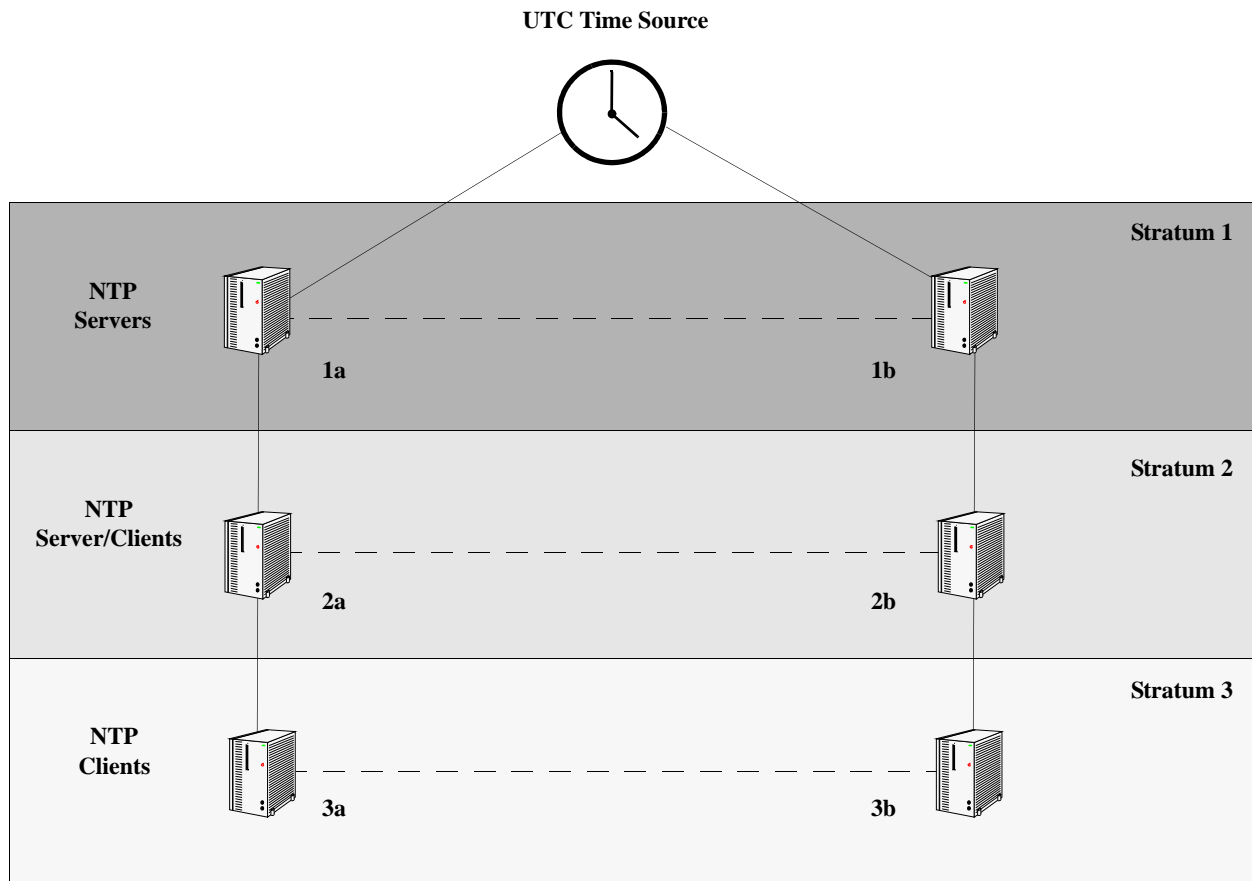

Servers 1a and 1b receive time information from, or synchronize with, a UTC time source such as a radio clock. (In most cases, these servers would not be connected to the same UTC source, though it is shown this way for simplicity.) Servers 1a and 1b become stratum 1 NTP servers and are peered with each other, allowing them to check UTC time information against each other. These machines support machines 2a and 2b as clients, and these clients are synchronized to the higher stratum servers 1a and 1b.

Clients 2a and 2b are also peered with each other for time checks, and become stratum 2 NTP servers for more clients (3a and 3b, which are also peered). In this hierarchy, the stratum 1 servers synchronize to the most accurate time source available, then check the time information with peers at the same stratum. The stratum 2 machines synchronize to the stratum 1 servers, but do not send time information to the stratum 1 machines. Machines 2a and 2b in turn provide time information to the stratum 3 machines. It is important to consider the issue of robustness when selecting sources for time synchronization.

It is suggested that at least three sources should be available, and at least one should be “close” to you in terms of network topology. It is also suggested that each NTP client is peered with at least three other same stratum clients, so that time information crosschecking is performed.

Note. Alcatel-Lucent current implementation of NTP only allows the OmniSwitch to act as a passive client, not as a server. A passive client only receives NTP information and adjusts its time accordingly. In the above example, an OmniSwitch could be either Server 3a or 3b. An OmniSwitch as Server 3a or 3b would also not be able to peer with other servers on the same stratum.

When planning your network, it is helpful to use the following general rules:

- It is usually not a good idea to synchronize a local time server with a peer (in other words, a server at the same stratum), unless the latter is receiving time updates from a source that has a lower stratum than from where the former is receiving time updates. This minimizes common points of failure.
- Peer associations should only be configured between servers at the same stratum level. Higher Strata should configure lower Strata, not the reverse.
- It is inadvisable to configure time servers in a domain to a single time source. Doing so invites common points of failure.

Note. NTP does not support year date values greater than 2035 (the reasons are documented in RFC 1305 in the data format section). This should not be a problem (until the year 2035) as setting the date this far in advance runs counter to the administrative intention of running NTP.

Authentication

NTP is designed to use MD5 encryption authentication to prevent outside influence upon NTP timestamp information. This is done by using a key file. The key file is loaded into the switch memory, and consists of a text file that lists key identifiers that correspond to particular NTP entities.

If authentication is enabled on an NTP switch, any NTP message sent to the switch must contain the correct key ID in the message packet to use in decryption. Likewise, any message sent from the authentication enabled switch is not readable unless the receiving NTP entity possesses the correct key ID.

The key file is a text (.txt) file that contains a list of keys that are used to authenticate NTP servers. It should be located in the **/networking** directory of the switch.

Key files are created by a system administrator independent of the NTP protocol, and then placed in the switch memory when the switch boots. An example of a key file is shown below:

```
2      M      RIrop8KPPvQvYotM      # md5 key as an ASCII random string
14     M      sundial           # md5 key as an ASCII string
```

In a key file, the first token is the key number ID, the second is the key format, and the third is the key itself. (The text following a “#” is not counted as part of the key, and is used merely for description.) The key format indicates an MD5 key written as a 1 to 31 character ASCII string with each character standing for a key octet.

The key file (with identical MD5 keys) must be located on both the local NTP client and the client’s server.

Configuring NTP

The following sections detail the various commands used to configure and view the NTP client software in an OmniSwitch.

Configuring the OmniSwitch as a Client

The NTP software is disabled on the switch by default. To activate the switch as an NTP client, enter the **ntp client** command as shown:

```
-> ntp client enable
```

This sets the switch to act as an NTP client in the passive mode, meaning the client receives updates from a designated NTP server.

To disable the NTP software, enter the **ntp client** command as shown:

```
-> ntp client disable
```

Setting the Client to Broadcast Mode

It is possible to configure an NTP client to operate in the broadcast mode. Broadcast mode specifies that a client switch listens on all interfaces for server broadcast timestamp information. It uses these messages to update its time.

To set an OmniSwitch to operate in the broadcast mode, enter the **ntp broadcast** command as shown:

```
-> ntp broadcast enable
```

A client in the broadcast mode does not need to have a specified server.

Setting the Broadcast Delay

When set to the broadcast mode, a client needs to advertise a broadcast delay. The broadcast mode is intended for operation on networks with numerous workstations and where the highest accuracy is not required. In a typical scenario, one or more time servers on the network, broadcast messages, which are received by NTP hosts. The correct time is determined from an NTP message based on a pre-configured latency or broadcast delay in the order of a few milliseconds.

To set the broadcast delay, enter the **ntp broadcast-delay** command as shown:

```
-> ntp broadcast delay 1000
```

NTP Servers

An NTP client needs to receive NTP updates from an NTP server. Each client must have at least one server with which it synchronizes (unless it is operating in broadcast mode). There are also adjustable server options.

Designating an NTP Server

To configure an NTP client to receive updates from an NTP server, enter the **ntp server** command with the server IP address or domain name, as shown:

```
-> ntp server 1.1.1.1
```

or

```
-> ntp server spartacus
```

It is possible to remove an NTP server from the list of servers from which a client synchronizes. To do this, enter the **ntp server** command with the **no** prefix, as shown:

```
-> no ntp server 1.1.1.1
```

Enabling/Disabling NTP Server Synchronization Tests

To enable an NTP client to invoke NTP server synchronization tests as specified by the NTP protocol, enter the **ntp server synchronized** command as shown:

```
-> ntp server synchronized
```

NTP synchronization is enabled by default.

Note. The NTP protocol discards the NTP servers that are unsynchronized.

To disable an NTP client from invoking tests for NTP server synchronization, enter the **ntp server unsynchronized** command, as shown:

```
-> ntp server unsynchronized
```

Disabling peer synchronization tests allows the NTP client to synchronize with either an NTP peer that is not synchronized with an atomic clock or a network of NTP servers that will finally synchronize with an atomic clock.

Setting the Minimum Poll Time

The minimum poll time is the number of seconds that the switch waits before requesting a time synchronization from the NTP server. This number is determined by raising 2 to the power of the number entered using the **ntp server** command with the server IP address (or domain name) and the **minpoll** keyword.

For example, to set the minimum poll time to 128 seconds, enter the following:

```
-> ntp server 1.1.1.1 minpoll 7
```

This would set the minimum poll time to $2^7 = 128$ seconds.

Setting the Version Number

There are currently four versions of NTP available (numbered one through four). The version that the NTP server uses must be specified on the client side.

To specify the NTP version on the server from which the switch receives updates, use the **ntp server** command with the server IP address (or domain name), **version** keyword, and version number, as shown:

```
-> ntp server 1.1.1.1 version 3
```

The default setting is version 4.

Marking a Server as Preferred

If a client receives timestamp updates from more than one server, it is possible to mark one of the servers as the preferred server. A preferred server's timestamp is used before another unpreferred server timestamp.

To specify an NTP as preferred, use the **ntp server** command with the server IP address (or domain name) and the **prefer** keyword, as shown:

```
-> ntp server 1.1.1.1 prefer
```

Using Authentication

Authentication is used to encrypt the NTP messages sent between the client and server. The NTP server and the NTP client must both have a text file containing the public and secret keys. (This file should be obtained from the server administrator. For more information on the authentication file, see [“Authentication” on page 4-8.](#))

Once both the client and server share a common MD5 encryption key, the MD5 key identification for the NTP server must be specified on and labeled as trusted on the client side.

Setting the Key ID for the NTP Server

Enabling authentication requires the following steps:

- 1 Make sure the key file is located in the **/networking** directory of the switch. This file must contain the key for the server that provides the switch with its timestamp information.
- 2 Make sure the key file with the NTP server's MD5 key is loaded into the switch memory by issuing the **ntp key load** command, as shown:

```
-> ntp key load
```

- 3 Set the server authentication key identification number using the **ntp server** command with the **key** keyword. This key identification number must be the one the server uses for MD5 encryption. For example, to specify key identification number 2 for an NTP server with an IP address of 1.1.1.1, enter:

```
-> ntp server 1.1.1.1 key 2
```

- 4 Specify the key identification set above as *trusted*. A key that has been labeled as trusted is ready for use in the authentication process. To set a key identification to be trusted, enter the **ntp key** command with the key identification number and **trusted** keyword. For example, to set key ID 5 to trusted status, enter the following:

```
-> ntp key 5 trusted
```

Untrusted keys, even if they are in the switch memory and match an NTP server, does not authenticate NTP messages.

- 5 A key can be set to untrusted status by using the **ntp key** command with the **untrusted** keyword. For example, to set key ID 5 to untrusted status, enter the following:

```
-> ntp key 5 untrusted
```

Verifying NTP Configuration

To display information about the NTP client, use the **show** commands listed in the following table:

show ntp client	Displays information about the current client NTP configuration.
show ntp server status	Displays the basic server information for a specific NTP server or a list of NTP servers.
show ntp client server-list	Displays a list of the servers with which the NTP client synchronizes.
show ntp keys	Displays information about all authentication keys.

For more information about the resulting displays from these commands, see the “NTP Commands” chapter in the *OmniSwitch AOS Release 6 CLI Reference Guide*.

Examples of the **show ntp client**, **show ntp server status**, and **show ntp client server-list** command outputs are given in the section “NTP Quick Steps” on page 4-3.

5 Managing CMM Directory Content

The CMM (Chassis Management Module) software runs the switches. The directory structure of the [CMM](#) software is designed to prevent corrupting or losing switch files. It also allows you to retrieve a previous version of the switch software.

In addition to working as standalone switches, OmniSwitches can be linked together as a stack. A stack can provide CMM redundancy; one switch is designated as the primary CMM, and one is designated as the secondary CMM. One CMM or the other runs the switch, but never at the same time. All other switches in a stack are designated “idle” for the purposes of CMM control.

Note. Mixing OmniSwitch 6350 and OmniSwitch 6450 models in the same stack is not supported.

Management of the stack is run by the stack configuration software. A detailed description of the stack configuration software and how it works is provided in the “Managing Stacks” chapter found in the related *OmniSwitch AOS Release 6350/6450 Hardware Users Guide*.

In This Chapter

This chapter describes the basic functions of CMM software directory management and how to implement them by using the Command Line Interface (CLI). CLI commands are used in the configuration examples; for more details about the syntax of commands, see the *OmniSwitch AOS Release 6 CLI Reference Guide*.

This chapter contains the following information:

- The interaction between the running configuration, the working directory, and the certified directory is described in [“CMM Files” on page 5-3](#).
- A description of how to restore older versions of files and prevent switch downtime is described in [“Software Rollback Feature” on page 5-4](#).
- The CLI commands available for use and the correct way to implement them are listed in [“Managing the Directory Structure \(Non-Redundant\)” on page 5-13](#).
- The CLI commands and issues involved in managing the directory structure of a stack with redundant CMM software is described in [“Managing Redundancy in a Stack and CMM” on page 5-25](#).
- The CLI command used to check the integrity of image files in working or certified directory is described in [“Checking the Integrity of the Image” on page 5-35](#)

CMM Specifications

Size of Flash Memory	128 Megabytes
Size of RAM Memory	256 Megabytes
Maximum Length of File Names	32 Characters
Maximum Length of Directory Names	32 Characters
Default Boot Directory	Certified

USB Flash Drive Specifications

Platforms Supported	OmniSwitch 6350, 6450
USB Flash Drive Support	Alcatel-Lucent Certified USB Flash Drive
Automatic Software Upgrade	Supported
Disaster Recovery	Supported

Note: The format of the Alcatel-Lucent Certified USB Flash Drive must be FAT. To avoid file corruption issues the USB Drive must be stopped before removing from a PC. Directory names are case sensitive and must be lower case.

CMM Files

The management of a stack or single switch is controlled by three types of files:

- Image files, which are proprietary code developed by Alcatel-Lucent to run the hardware. These files are not configurable by the user, but can be upgraded from one release to the next. These files are also known as archive files as they are really the repository of several smaller files grouped under a common heading.
- A configuration file, named **boot.cfg**, which is an ASCII-based text file, sets and controls the configurable functions inherent in the image files provided with the switch. This file can be modified by the user. When the switch boots, it looks for the file called **boot.cfg**. It uses this file to set various switch parameters defined by the image files.
- A boot file on the OmniSwitch, named **boot.slot.cfg**, is an ASCII-based text file that numbers the switches in a stack. A boot file on the OmniSwitch, named **boot.params**, is an ASCII-based text file that sets the Ethernet Management Port (EMP) IP address, gateway, and mask. It also controls the baud rate of the console port and displays directory loading information and is located in the Flash memory of the switch.

Modifications to the switch parameters affect or change the configuration file. The image files are static for the purposes of running the switch (though they can be updated and revised with future releases or enhancements). Image and configuration files are stored in the Flash memory (which is equivalent to a hard drive memory) in specified directories. When the switch is running, it loads the image and configuration files from the Flash memory into the RAM. When changes are made to the configuration file, the changes are first stored in the RAM. The procedures for saving these changes through the CLI are detailed in the sections to follow.

CMM Software Directory Structure

The directory structure that stores the image and configuration files is divided into two parts:

- The *certified directory* contains files that have been certified by an authorized user as the default files for the switch. If the switch reboots, it would reload the files in the certified directory to reactivate its functionality.
- The *working directory* contains files that can or cannot be altered from the certified directory. The working directory is a holding place for new files. Files in the working directory must be tested before committing them to the certified directory. You can save configuration changes to the working directory. You can reboot the switch from the working directory by using the **reload working** command as described in [“Rebooting from the Working Directory” on page 5-18](#).

The *running configuration* is the current operating parameters of the switch obtained from information from the image and configuration files. The running configuration is in the RAM.

Where is the Switch Running From?

When a switch has booted and is running, the software used comes either from the certified directory or the working directory. In most instances, the switch boots from the certified directory. (A switch can be booted from the working directory by using the **reload working** command described in [“Rebooting from the Working Directory” on page 5-18.](#))

Once the switch is booted and functioning, the switch is said to be running from a particular directory, either the working or certified directory. Where the switch is running from is determined at the time of the boot-up of the switch.

At the time of a normal boot (by turning on the switch power on or by using the **reload** command), a comparison is made between the working directory and the certified directory. If the directories are synchronized (all files are the same in both directories), the switch runs from the working directory. If there is any discrepancy between the two directories (even as small as a different file size or file date), the switch runs from the certified directory.

While a switch is running from the certified directory, *you cannot save any changes made in the running configuration*. If the switch reboots, the changes made to switch parameters is lost. In order to save running configuration changes, the switch must be running from the working directory. You can determine where the switch is running from by using the **show running directory** command described in [“Show Currently Used Configuration” on page 5-23.](#)

Software Rollback Feature

The directory structure inherent in the CMM software allows for a switch to return to a previous, more reliable version of image or configuration files.

Initially, when normally booting the switch, the software is loaded from the certified directory. This is the repository for the most reliable software. When the switch is booted, the certified directory is loaded into the running configuration and used to manage switch functionality.

Changes made to the configuration file in the running configuration alters the switch functionality. These changes are not saved unless explicitly done so by the user using the **copy running-config working** command described in [“Copying the Running Configuration to the Working Directory” on page 5-16.](#) If the switch reboots before the configuration file in the running configuration is saved, then the certified directory is reloaded to the running configuration and changes made to the configuration file in the running configuration prior to the reboot are lost.

Changes to the configuration file have to be initially saved to the working directory by using the **copy running-config working** or the **write-memory** commands. Once the configuration file is saved to the working directory, the switch can be rebooted from the working directory. To reboot, use the **reload working** command, described in [“Rebooting from the Working Directory” on page 5-18.](#)

Likewise, new image files are always placed in the working directory first. The switch can then be rebooted from the working directory. When this is done, the contents of the working directory are loaded and used to set up the running configuration, which is used to control switch functionality. New image or configuration files can now be tested for a time to decide whether they are reliable.

Should the configuration or images files prove to be less reliable than their older counterparts in the certified directory, then the switch can be rebooted from the certified directory. The switch can be “rolled back” to an earlier version.

Once the contents of the working directory are established as good files, then these files can be saved to the certified directory and used as the most reliable software to which the switch can be rolled back in an emergency situation.

Software Rollback Configuration Scenarios for a Single Switch

The following examples illustrate a few likely scenarios and explain how the running configuration, working directory, and certified directory interoperate to facilitate the software rollback on a single switch.

Note. This information applies to a switch stack; however, the manner in which CMM software is propagated to all switches in a stack is explained in “Redundancy Scenarios” on page 5-9.

In the following examples, **R** represents the running configuration, **W** represents the working directory, and **C** represents the certified directory.

Note. For the following scenarios, it is important to remember the difference between where the switch boots from, and where the switch is running from. See “Where is the Switch Running From?” on page 5-4 for more information.

Scenario 1: Running Configuration Lost After Reboot

Switch X is new from the factory. It is plugged in and booted up from the certified directory, the contents of which are loaded into the running configuration. Since the working and certified directories are the same, the switch is running from the working directory. Through the course of several days, changes are made to the configuration file in the running configuration.

Power to the switch is interrupted, the switch reboots from the certified directory, all the changes in the running configuration are overwritten, and the switch rolls back to the certified directory (which in this case is the factory setting).

This is illustrated in the following diagram:

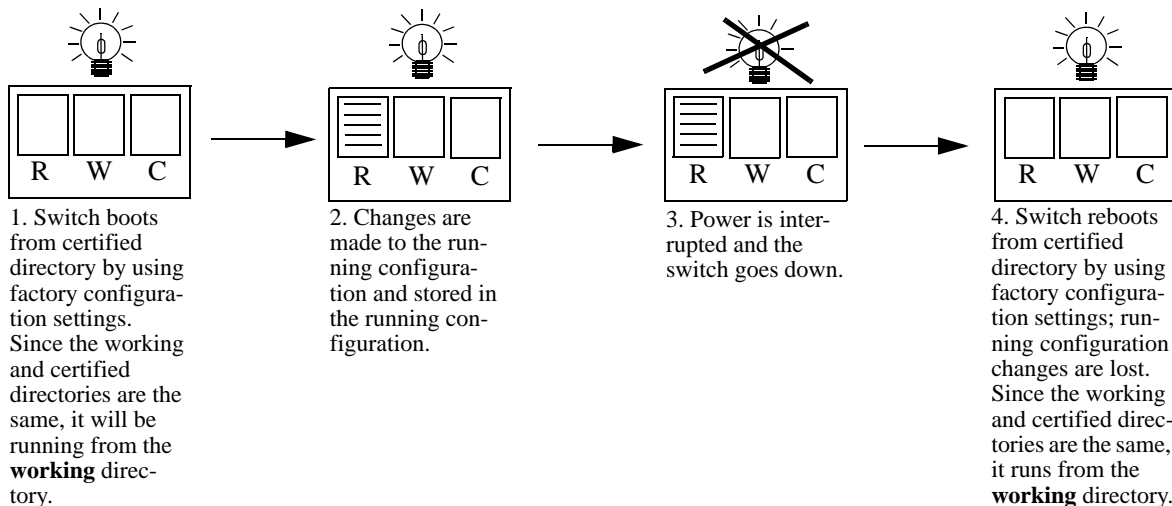

Running Configuration is Overwritten by the Certified Directory on Boot

Scenario 2: Running Configuration Saved to Working Directory

The network administrator recreates the running configuration of Switch X and immediately saves the running configuration to the working directory.

In another mishap, the power to the switch is again interrupted. The switch reboots from certified directory, overwrites all of the changes in the running configuration, and rolls back to the certified directory (which in this case is the factory settings). However, since the configuration file was saved to the working directory, that file is still in the working directory and can be retrieved. Since the working and certified directories are not the same, the switch is running from the certified directory.

This is illustrated in the following diagram:

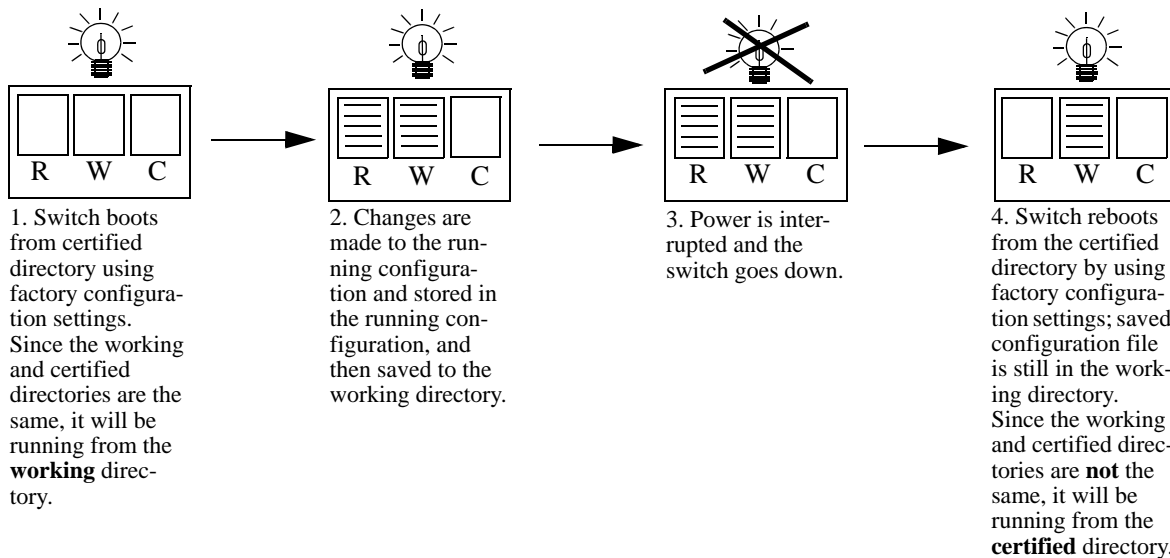

Running Configuration Saved to Working Directory

It is important to note that in the preceding scenario, the switch is using the configuration file from the certified directory, and not the working directory. The changes made and saved to the working directory are not in effect. The switch can be booted from the working directory by using the **reload working** command.

Scenario 3: Saving the Working Directory to the Certified Directory

After running the modified configuration settings and checking that there are no problems, the network administrator decides that the modified configuration settings (stored in the working directory) are reliable. The administrator then decides to save the contents of the working directory to the certified directory. Once the working directory is saved to the certified directory, the modified configuration file is included in a normal reboot.

Since the working and certified directories are the same, the switch is running from the working directory.

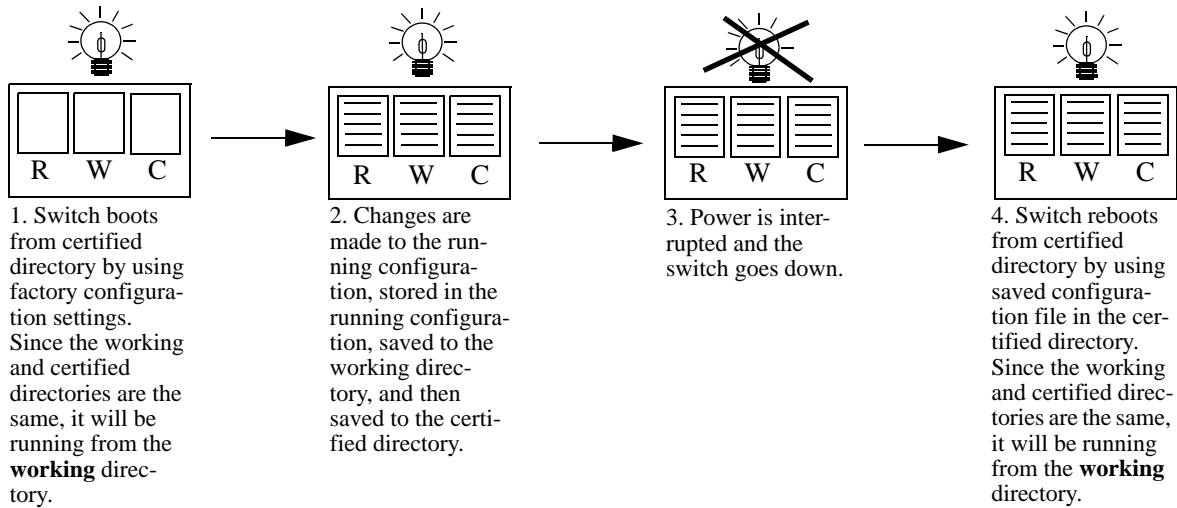

Running Configuration is Saved to Working, then to the Certified Directory

Scenario 4: Roll back to Previous Version of Switch Software

Later that year, an upgraded image file is released from Alcatel-Lucent. The network administrator loads the new file through FTP to the working directory of the switch and reboots the switch from the working directory. Since the switch is booted from the working directory, the switch is running from the working directory.

After the reboot loads the new image file from the working directory, it is discovered that the image file was corrupted during the FTP transfer. Rather than having a disabled switch, the network administrator can reboot the switch from the certified directory (which has the previous, more reliable version of the ENI image file) and wait for a new version of the image. In the meantime, the administrator's switch is still functioning.

This is illustrated in the following diagram:

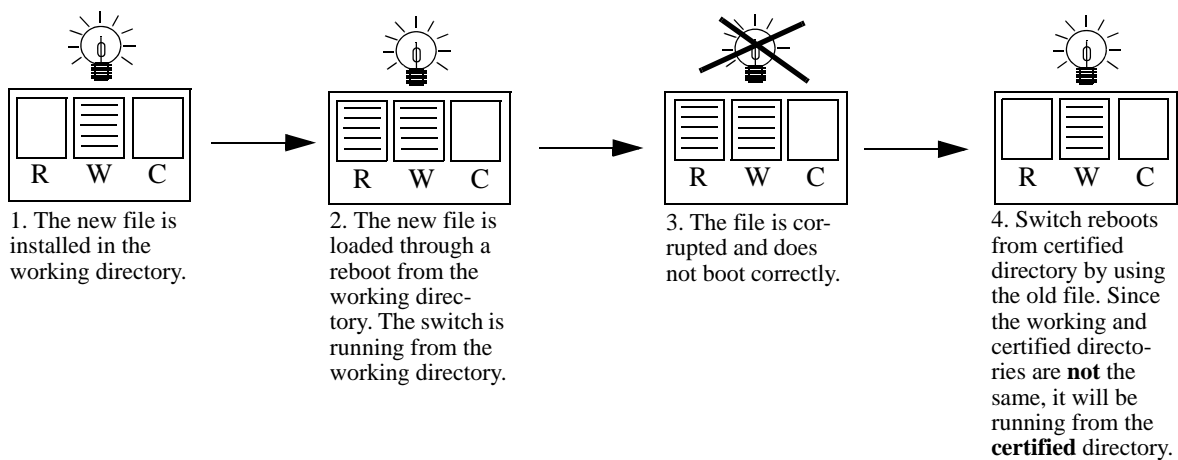

Switch Rolls Back to Previous File Version

Redundancy

CMM software redundancy is one of the switch's most important fail over features. For CMM software redundancy, at least two fully-operational switches must be linked together as a stack. In addition, the CMM software must be synchronized. (Refer to [“Synchronizing the Primary and Secondary CMMs”](#) on page 5-27 for more information.)

In a stack of switches, one of the switches has the primary role and the other switch has the secondary role at any given time. (The primary and secondary roles are determined by the switch number indicated on the LED on the front panel; the lowest number switch becomes the primary switch in the stack.) The primary switch manages the current switch operations while the secondary switch provides backup (also referred to as “fail over”).

Additional switches in a stack are set to “idle” for the purposes of redundancy. For more information on managing a stack of switches, see the “Managing Stacks” chapter found in the related *OmniSwitch AOS Release 6350/6450 Hardware Users Guide*.

When two CMMs are running in a stack, one CMM has the primary role and the other has the secondary role at any given time. The primary CMM manages the current switch operations while the secondary CMM provides backup (also referred to as “fail over”).

Redundancy Scenarios

The following scenarios demonstrate how the CMM software is propagated to other switches in a stack for the purposes of coherent redundancy. In the examples below, **W** represents the working directory and **C** represents the certified directory.

Scenario 1: Booting the Stack

The following diagram illustrates what occurs when a stack powers up. The stack displayed is a three-switch stack.

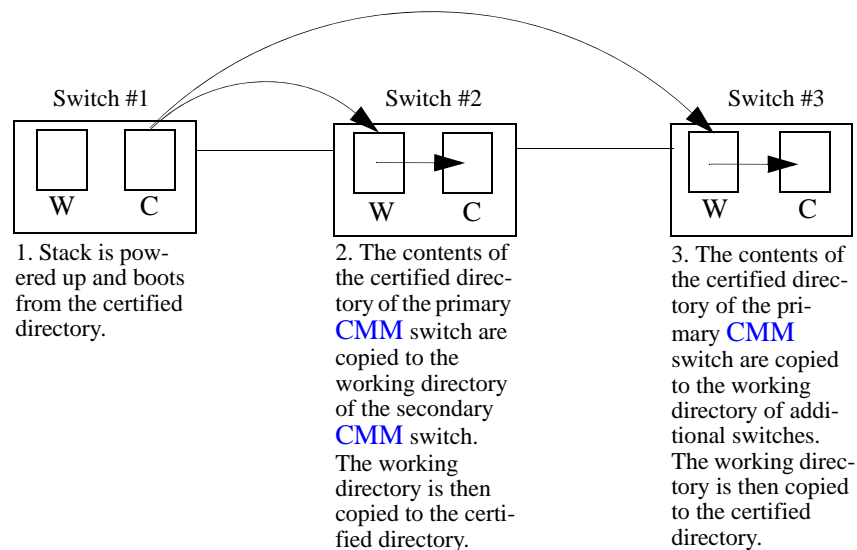

Powering Up a Stack

This process occurs automatically when the switch boots. The working and certified directory relationship described in the preceding figure in [“Software Rollback Feature” on page 5-4](#) continues to apply to the primary CMM switch.

Generally speaking, the switch assigned the lowest stack number is the primary CMM switch; the switch with the next lowest stack number is the secondary CMM switch, and all other switches are idle. For more information on stack numbering, see the “Managing Stacks” chapter found in the related *OmniSwitch AOS Release 6350/6450 Hardware Users Guide*.

Scenario 2: Rebooting from the Working Directory

Since changes to the `boot.cfg` file and `new.img` files are initially saved to the working directory, sometimes it is necessary to boot from the working directory to check the validity of the new files. The following diagram illustrates the synchronization process of a working directory reboot. The stack displayed is a three switch stack.

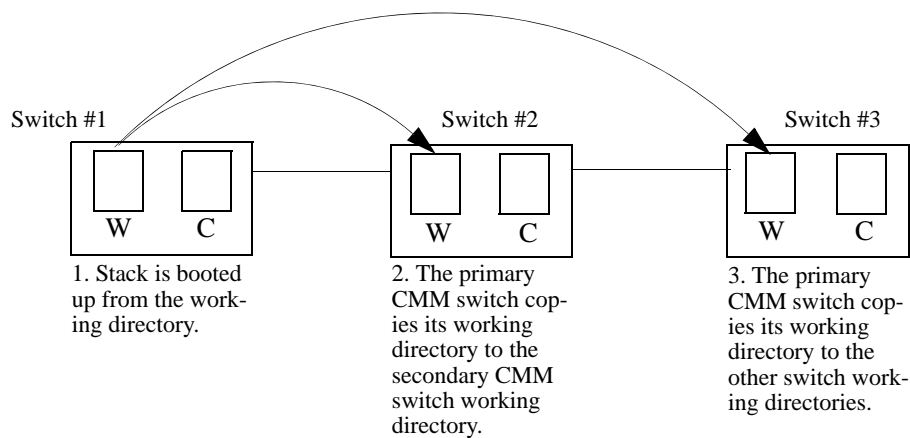

Booting from the Working Directory

This synchronization process occurs automatically on a working directory reboot.

Note. It is important to certify the working directory and synchronize the stack as soon as the validity of the software is established. Stacks booted from the working directory or unsynchronized stacks are at risk of mismanaging data traffic due to incompatibilities in different versions of switch software. Certifying the working directory is described in [“Copying the Working Directory to the Certified Directory” on page 5-21](#), while synchronizing the switch is described in [“Synchronizing the Primary and Secondary CMMs” on page 5-27](#).

Scenario 3: Synchronizing Switches in a Stack

When changes have been made to the primary CMM switch certified directory, these changes have to be propagated to the other switches in the stack. This could be done by rebooting the stack. However, a loss of switch functionality is to be avoided, a **copy flash-synchro** command can be issued.

The following diagram illustrates the process that occurs when using a copy flash-synchro command. The stack shown is a three switch stack.

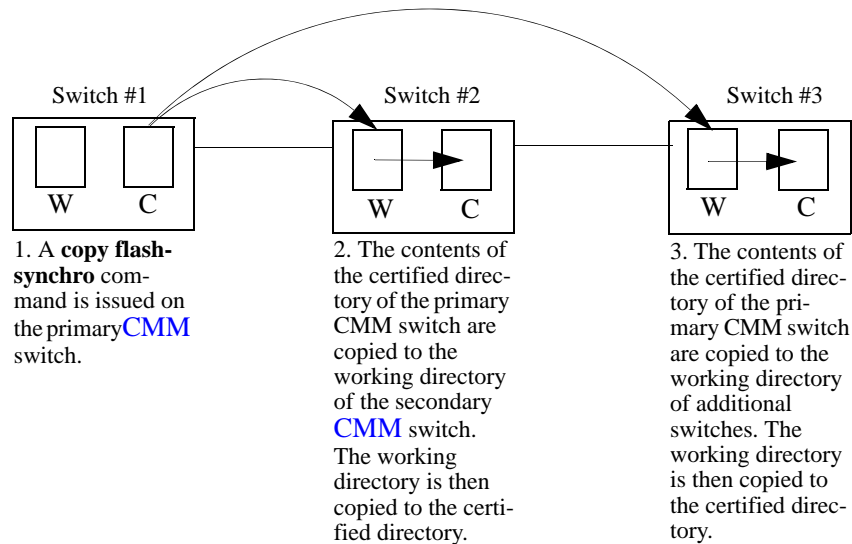

Synchronizing Switches in a Stack

The **copy flash-synchro** command (described in [“Synchronizing the Primary and Secondary CMMs” on page 5-27](#)) can be issued on its own, or in conjunction with the **copy working certified** command (described in [“Copying the Working Directory to the Certified Directory” on page 5-26](#)).

Note. It is important to certify the working directory and synchronize the stack as soon as the validity of the software is established. Stacks booted from the working directory or unsynchronized stacks are at risk of mismanaging data traffic due to incompatibilities in different versions of switch software. Certifying the working directory is described in [“Copying the Working Directory to the Certified Directory” on page 5-21](#), while synchronizing the switch is described in [“Synchronizing the Primary and Secondary CMMs” on page 5-27](#).

Scenario 4: Adding a New Switch to a Stack

Since the OmniSwitch is designed to be expandable, it is likely that new switches are added to stacks. The stack automatically detects new switches added to the stack, and new switches can pass traffic without a complete reboot of the stack.

However, a new switch added to the stack may not have the same software as the rest of the stack. In this case, the new switch must be synchronized with the stack software.

The following diagram illustrates this idea. The diagram shows a stack of three switches to which a fourth switch is added.

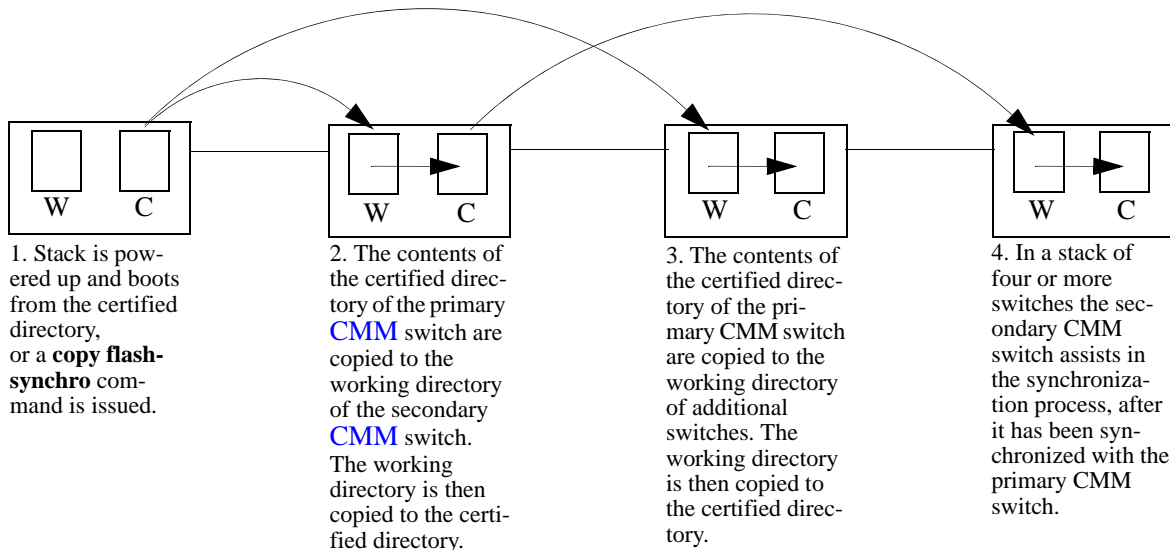

Synchronizing a Stack with Three More Switches

Managing the Directory Structure (Non-Redundant)

The following sections define commands that allow the user to manipulate the files in the directory structure of a single CMM.

Note. All of the commands described in the following sections work on switches in a stack with redundancy enabled. However, there can be special circumstances that apply when modifying parameters on a switch in a stack that do not apply to a single switch. Redundant command usage is covered in [“Managing Redundancy in a Stack and CMM” on page 5-25](#). See the related *OmniSwitch AOS Release 6350/6450 Hardware Users Guide* for more information on switch redundancy.

Rebooting the Switch

When booting the switch, the software in the certified directory is loaded into the RAM memory of the switch and used as a running configuration, as shown:

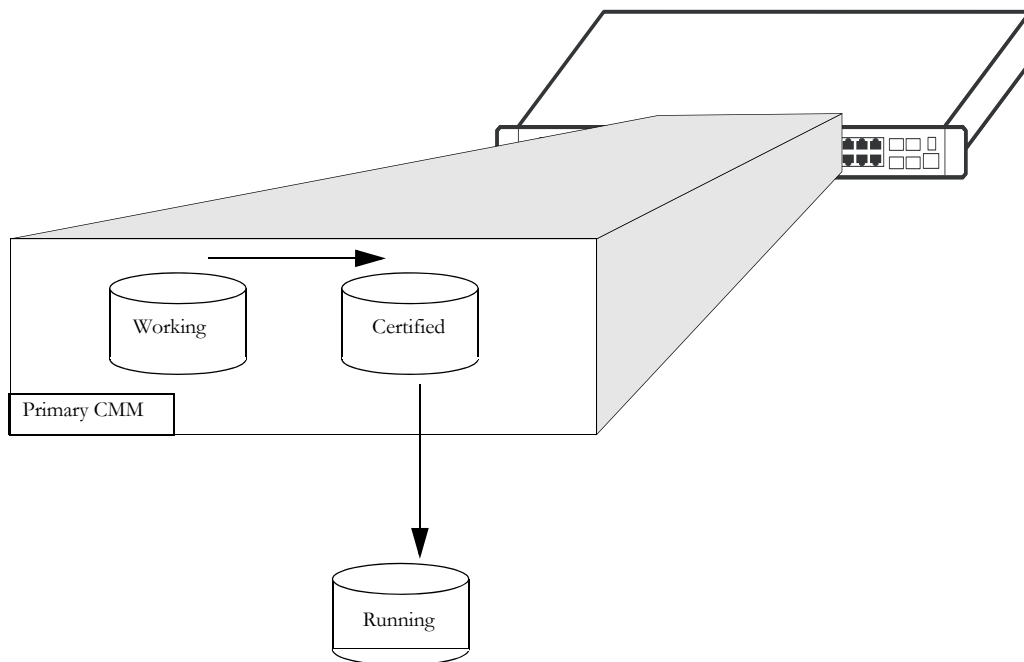

The certified directory software should be the best, most reliable versions of both the image files and the **boot.cfg** file (configuration file). The switch runs from the certified directory after boot if the working and certified directories are not the same. If they are the same, then the switch runs from the working directory, allowing changes made to the running configuration to be saved. If the switch is running from the certified directory, you cannot save any changes to the running configuration, or copy files between the directories.

To reboot the switch from the certified directory, enter the **reload** command at the prompt:

```
-> reload
```

This command loads the image and configuration files in the certified directory into the RAM memory. These files control the operation of the switch.

Note. When the switch reboots using the **reload** command, it boots up from the certified directory. Any information in the running configuration that has not been saved to the working directory is lost.

Scheduling a Reboot

It is possible to cause a reboot of the primary or secondary CMM at a future time by setting time parameters in conjunction with the **reload** command, using the **in** or **at** keywords.

To schedule a reboot of the primary CMM in 3 hr and 3 min, you would enter:

```
-> reload primary in 3:03
```

To schedule a reboot of the primary CMM for June 30 at 8:00 pm, you would enter:

```
-> reload primary at 20:00 june 30
```

Note. Scheduled reboot times has to be entered in military format (a twenty-four hour clock).

Canceling a Scheduled Reboot

To cancel a scheduled reboot, use the **cancel** keyword. A cancel command can be specified for a primary reboot, a secondary reboot, or all currently scheduled reboots. for example, to cancel the primary reboot set above, enter the following:

```
-> reload primary cancel
```

To cancel all scheduled reboots with a single command, enter the following:

```
-> reload cancel
```

Checking the Status of a Scheduled Reboot

You can check the status of a reboot set for a later time by entering the following command:

```
-> show reload
```

or

```
-> show reload status
```

The **reload** command is described in detail in the *OmniSwitch AOS Release 6 CLI Reference Guide*.

Copying the Running Configuration to the Working Directory

Once the switch has booted and is running, a user can modify various parameters of switch functionality. These changes are stored temporarily in the running configuration in the RAM of the switch. In order to save these changes, the running configuration must be saved to the working directory as shown:

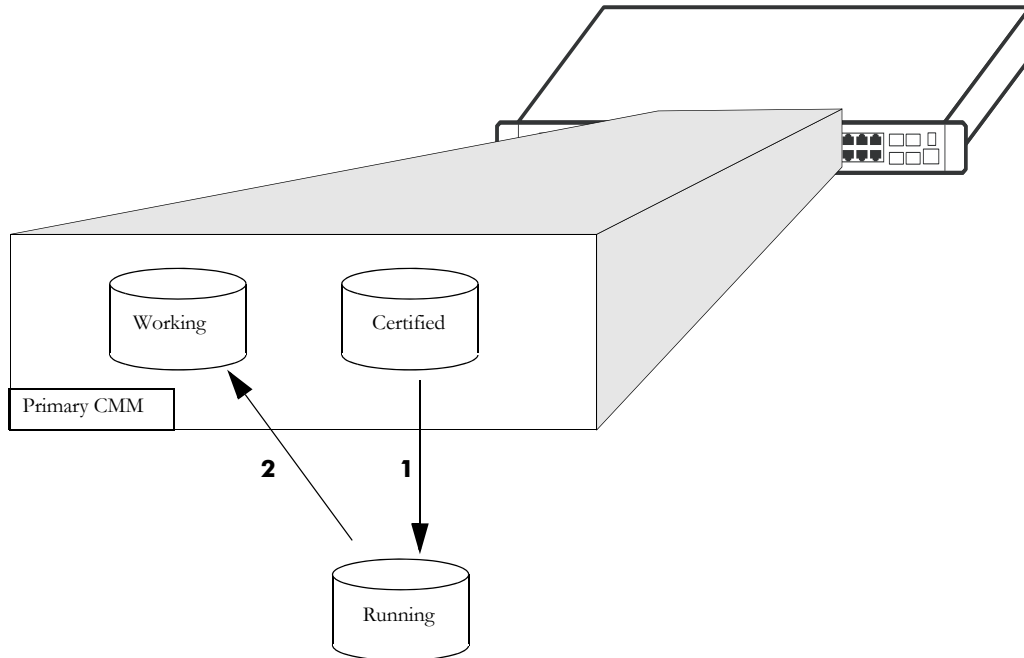

In this diagram:

- 1** The switch boots from the certified directory, and the software is loaded to the RAM to create a running configuration.
- 2** Changes are made in the running configuration and are saved to the working directory.

Now the **boot.cfg** file in the running configuration and the **boot.cfg** file in the working directory are identical. Should the switch go down or reboot, the configuration changes made can be restored.

Note. If the switch is rebooted at this point in the process, since the certified and working directory **boot.cfg** files are not the same, the switch boots up and runs from the certified directory. (See [“Where is the Switch Running From?”](#) on page 5-4 for a description of this process.)

The modifications made to the functionality of the switch are recorded in the running configuration, in the RAM. These changes in the RAM are only valid until the switch is rebooted. At that time, the switch reboots from the certified directory. If the running configuration is not saved to the working directory before a reboot, then the changes made in the running configuration are lost. To save these changes, it is necessary to save the contents of the running configuration to the working directory.

To save the running configuration to the working directory, enter the **copy running-config working** or **write memory**, or **copy flash-syncro** command at the prompt. A trap is raised to enforce a poll whenever a configuration file is saved. The configuration changes that are not committed are not detected by the switch until these commands are applied as follows:

```
-> copy running-config working
```

or

```
-> write memory
```

The preceding commands perform the same function. When these commands are issued the running configuration with all modifications made is saved to a file called **boot.cfg** in the working directory.

Note. This command does not function if the switch is running from the certified directory. See [“Where is the Switch Running From?”](#) on page 5-4 for an explanation.

The **copy running-config working** and **write memory** commands are described in detail in the *OmniSwitch AOS Release 6 CLI Reference Guide*.

Note. The saved **boot.cfg** file is overwritten if the **takeover** command is executed after the **copy running-config working** or **write memory** commands in an OmniSwitch set up with redundant CMMs.

Note. It is important to certify the working directory and synchronize the stack as soon as the validity of the working directory software is established. Stacks booted from the working directory or unsynchronized stacks are at risk of mismanaging data traffic due to incompatibilities in different versions of switch software. Certifying the working directory is described in [“Copying the Working Directory to the Certified Directory”](#) on page 5-21, while synchronizing the switch is described in [“Synchronizing the Primary and Secondary CMMs”](#) on page 5-27.

Rebooting from the Working Directory

Besides a regular boot of the switch (from the certified directory), you can also force the switch to boot from the working directory. This is useful for checking whether a new configuration or image file boots up the switch correctly, before committing it to the certified directory. (For information on saving the working directory to the certified directory, see [“Copying the Working Directory to the Certified Directory”](#) on page 5-21.)

The following picture illustrates the case of a switch being rebooted from the working directory:

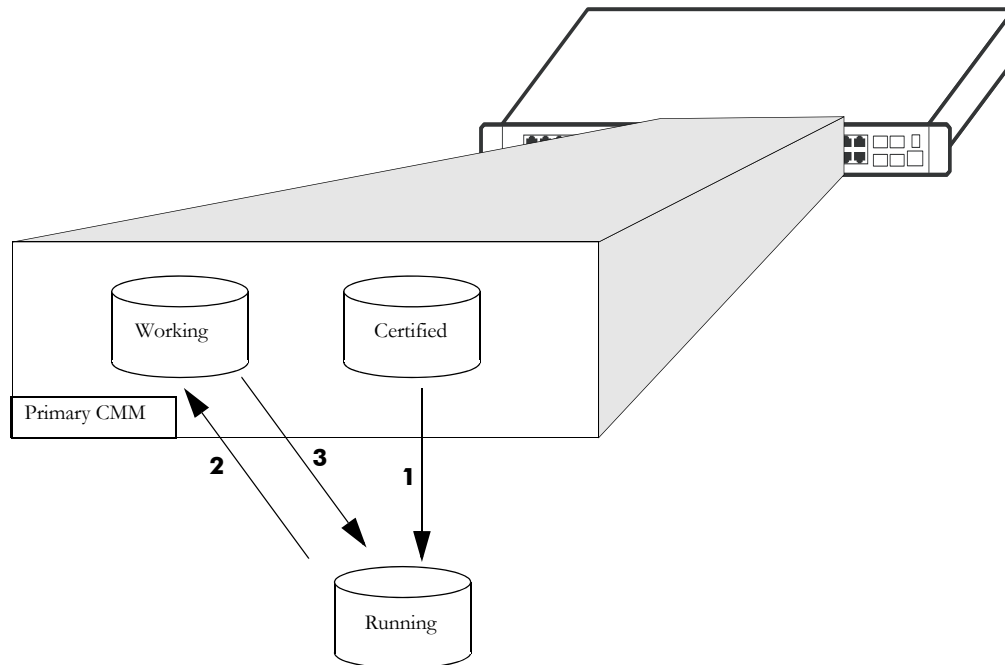

In the above diagram:

- 1 The certified directory is used to initially boot the switch.
- 2 Changes are made to the configuration file and are saved to the configuration file in the working directory by using the **copy running-config working** command, described in the section [“Copying the Running Configuration to the Working Directory”](#) on page 5-16.
- 3 The switch is rebooted from the working directory by using the **reload working** command.

When a **reload working** command is entered, the switch prohibits a takeover from the secondary CMM. Switch functions are suspended until the boot process is complete.

If you decide against using the new software booted from the working directory, the switch can revert to the software stored in the certified directory by using the **copy certified working** command as described in [“Copying the Certified Directory to the Working Directory”](#) on page 5-22, or by using the **reload** command as described in [“Rebooting the Switch”](#) on page 5-13.

Note. If the switch is rebooted before using the **copy certified working** command, the switch runs from the certified directory as the working and certified directories are not the same. This behavior is described in [“Where is the Switch Running From?” on page 5-4](#).

To reboot the switch from the working directory, enter the following command at the prompt, along with a timeout period (in minutes), as shown:

```
-> reload working rollback-timeout 5
```

At the end of the timeout period, the switch reboots again normally, as if a **reload** command had been issued.

Note. It is important to certify the working directory and synchronize the stack as soon as the validity of the software is established. Stacks booted from the working directory or unsynchronized stacks are at risk of mismanaging data traffic due to incompatibilities in different versions of switch software. Certifying the working directory is described in [“Copying the Working Directory to the Certified Directory” on page 5-21](#), while synchronizing the switch is described in [“Synchronizing the Primary and Secondary CMMs” on page 5-27](#).

Rebooting the Switch from the Working Directory with No Rollback Timeout

It is possible to reboot from the working directory without setting a rollback timeout, in the following manner:

```
-> reload working no rollback-timeout
```

Scheduling a Working Directory Reboot

It is possible to cause a working directory reboot of the CMM at a future time by setting time parameters in conjunction with the **reload working** command, using the **in** or **at** keywords. You still need to specify a rollback time-out time, or that there is no rollback.

To schedule a working directory reboot of the CMM in 3 hr and 3 min with no rollback time-out, you would enter:

```
-> reload working no rollback-timeout in 3:03
```

To schedule a working directory reboot of the CMM at 8:00pm with a rollback time-out of 10 minutes, you would enter:

```
-> reload working rollback-timeout 10 at 20:00
```

Note. Scheduled reboot times should be entered in military format (a twenty-four hour clock).

Canceling a Rollback Timeout

To cancel a rollback time-out, enter the **reload cancel** command as shown:

```
-> reload primary cancel
```

or

```
-> reload cancel
```

The **reload working** command is described in detail in the *OmniSwitch AOS Release 6 CLI Reference Guide*.

Copying the Working Directory to the Certified Directory

When the running configuration is saved to the working directory, the working and certified directories of the switch are now different. This difference, if the CMM reboots, causes the switch to boot and run from the certified directory. When the switch is booted and run from the certified directory, changes made to switch functionality cannot be saved and files cannot be moved between directories. The **boot.cfg** file saved on the working directory has to be saved to the certified directory, as shown:

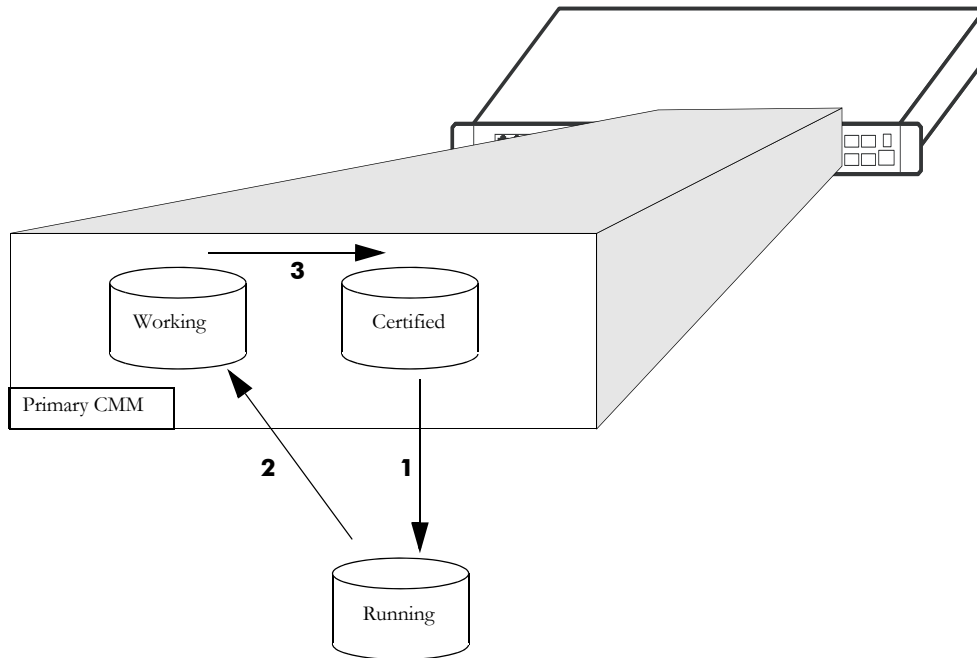

In this diagram:

- 1** The switch boots from the certified directory and changes are made to the running configuration.
- 2** The changes are saved to the working directory as the **boot.cfg** file.
- 3** The contents of the working directory are saved to the certified directory.

Once the working directory is copied to the certified directory, and the switch reboots, it reboots from the certified directory but run from the working directory. When the switch runs in this fashion, changes made to the running configuration can be saved to the working directory as described in [“Copying the Running Configuration to the Working Directory”](#) on page 5-16.

Note. Only software that has been thoroughly validated as viable and reliant software has to be copied to the certified directory. Once you copy software to the certified directory, you will not be able to recover a previous version of the image or configuration files.

When the software on the working directory of a switch has proven to be effective and reliable, eventually the contents of the working directory should be copied into the certified directory.

To copy the contents of the working directory to the certified directory, enter the following command at the prompt:

```
-> copy working certified
```

The **copy working certified** command is only valid if the switch is running from the working directory. If you attempt to copy the working directory to the certified directory when the switch is running from the certified directory, nothing happens, and the files in the certified directory remains unchanged.

Note. In order for this command to work, the amount of free space in flash must equal the size of the files being copied. If there is not enough free space, the copy attempt fails and an error message is generated. Only image files, the boot.cfg file, and the certs.pem file should be kept in the working directory.

Note. It is important to synchronize the stack as soon as the validity of the software is established. Unsynchronized stacks are at risk of mismanaging data traffic due to incompatibilities in different versions of switch software. Synchronizing the switch is described in [“Synchronizing the Primary and Secondary CMMs” on page 5-27](#).

Copying the Certified Directory to the Working Directory

It is possible to copy the contents of the certified directory to the working directory. This is done by using the following CLI command:

```
-> copy certified working
```

If this command is executed, all files in the working directory is permanently overwritten by the contents of the certified directory.

The **copy working certified** command is described in detail in the *OmniSwitch AOS Release 6 CLI Reference Guide*.

Note. In order for this command to work, the amount of free space in flash must equal the size of the files being copied. If there is not enough free space, the copy attempt fails and an error message is generated. Only image files, the boot.cfg file, and the certs.pem file should be kept in the certified directory.

Show Currently Used Configuration

When a switch is booted, the certified and working directories are compared. If they are the same, the switch runs from the working directory. If they are different, the switch runs from the certified directory. A switch running from the certified directory cannot modify directory contents. (This topic is covered in [“Where is the Switch Running From?”](#) on page 5-4.)

To check the directory from where the switch is currently running, enter the following command:

```
->show running-directory

CONFIGURATION STATUS
  Running CMM           : PRIMARY,
  CMM Mode              : DUAL CMMs,
  Current CMM Slot     : 1,
  Running configuration : WORKING,
  Certify/Restore Status : CERTIFY NEEDED

SYNCHRONIZATION STATUS
  Flash Between CMMs    : SYNCHRONIZED,
  Running Configuration : NOT AVAILABLE,
  Stacks Reload on Takeover: ALL STACKS (SW Activation)
```

The command returns the directory the switch is currently running from (working or certified) and which CMM is currently controlling the switch (primary or secondary). It also displays whether the working and certified directories are the same, and if a synchronization is needed between the primary and secondary CMM.

The [show running-directory](#) command is described in detail in the *OmniSwitch AOS Release 6 CLI Reference Guide*.

Show Switch Files

The files currently installed on a switch can be viewed using the **show microcode** command. This command displays the files currently in the specified directory.

To display files on a switch, enter the **show microcode** command with a directory, as shown:

```
-> show microcode certified
Package           Release           Size           Description
-----+-----+-----+-----
KFbase.img       6.7.1.20.R02     17364947      Alcatel-Lucent Base Software
KFos.img         6.7.1.20.R02     2607699       Alcatel-Lucent OS
KFeni.img        6.7.1.20.R02     5944695       Alcatel-Lucent NI software
KFsecu.img       6.7.1.20.R02     618493        Alcatel-Lucent Security Management
KFdiag.img       6.7.1.20.R02     2411898       Alcatel-Lucent Diagnostic Software
```

If no directory is specified, the files that have been loaded into the running configuration are shown.

Managing Redundancy in a Stack and CMM

The following section describe circumstances that the user should be aware of when managing the CMM directory structure on a stack with redundant CMMs. It also includes descriptions of the CLI commands designed to synchronize software between the primary and secondary CMMs.

Rebooting the Switch

When you reload the primary switch CMM in a stack, the secondary switch takes over the primary function. If the stack is comprised of three or more switches, then the original primary switch becomes “idle” and the next available “idle” switch becomes the secondary CMM. For more information on stacks, see the “Managing Stacks” chapter found in the *OmniSwitch AOS Release 6350/6450 Hardware Users Guide*.

You can specify a reboot of the secondary CMM by using the **secondary** keyword in conjunction with the **reload** command. For example, to reboot the secondary CMM, enter the **reload** command as shown:

```
-> reload secondary
```

In this case, the current primary CMM continues to run, while the secondary CMM reboots.

Scheduling a Reboot

It is possible to cause a reboot of the primary or secondary CMM at a future time by setting time parameters in conjunction with the **reload** command.

For example, to schedule a reboot of the secondary CMM in 8 hours and 15 minutes on the same day, enter the following at the prompt:

```
-> reload secondary in 08:15
```

Note. Scheduled reboot times should be entered in military format (a twenty-four-hour clock).

Canceling a Scheduled Reboot

To cancel a scheduled reboot, use the **cancel** keyword. A cancel command can be specified for a primary reboot, a secondary reboot, or all currently scheduled reboots. For example, to cancel the primary reboot set in the preceding example, enter the following:

```
-> reload secondary cancel
```

Secondary CMM Fail Over

While rebooting the switch during normal operation, a secondary CMM is installed, the switch will “fail over” to the secondary CMM. “Fail over” means the secondary CMM takes the place of the primary CMM. This prevents the switch from ceasing functionality during the boot process.

When the primary switch CMM in a stack fails over, the secondary switch takes over the primary function. If the stack comprises three or more switches, then the original primary switch becomes “idle” and the next available “idle” switch becomes the secondary CMM. For more information on stacks, see the “Managing Stacks” chapter found in the *OmniSwitch AOS Release 6350/6450 Hardware Users Guide*.

Synchronizing the primary and secondary CMMs is done using the **copy flash-synchro** command described in “[Synchronizing the Primary and Secondary CMMs](#)” on page 5-27.

Note. If a switch fails over to the secondary CMM, it is necessary to have a management interface connection to the secondary CMM (such as an Ethernet port or a console port).

Copying the Working Directory to the Certified Directory

Synchronizing the Primary and Secondary CMMs

At the same time that you copy the working directory to the certified directory, you can synchronize the secondary CMM with the primary CMM. In the case of redundant CMMs, this ensures that the two modules are booting from the same software.

To copy the working directory to the certified directory of the primary CMM and at the same time synchronize the software of the primary and secondary CMM, use the following command:

```
-> copy working certified flash-synchro
```

Note. This command does not function if the switch is running from the certified directory. See [“Where is the Switch Running From?”](#) on page 5-4 for an explanation.

The **copy working certified** command synchronizes all switches in a stack. This command is described in detail in the *OmniSwitch AOS Release 6 CLI Reference Guide*.

Note. When synchronizing the primary and secondary CMMs, it is important to remember that the **boot.params** file and the switch date and time are not automatically synchronized. See the *OmniSwitch AOS Release 6350/6450 Hardware Users Guide* for information on the **boot.params** file, and [Chapter 1, “Managing System Files,”](#) for information on setting the switch date and time. The date and time are synchronized using the **system time-and-date synchro** command.

Synchronizing the Primary and Secondary CMMs

If you have a secondary CMM in your switch, it is necessary to synchronize the software between the primary and secondary CMMs. If the primary CMM goes down (for example, during a reboot), then the switch fails over to the secondary CMM. If the software in the secondary CMM is not synchronized with the software in the primary CMM, the switch does not function as configured by the administrator.

The synchronization process is shown in the following diagram :

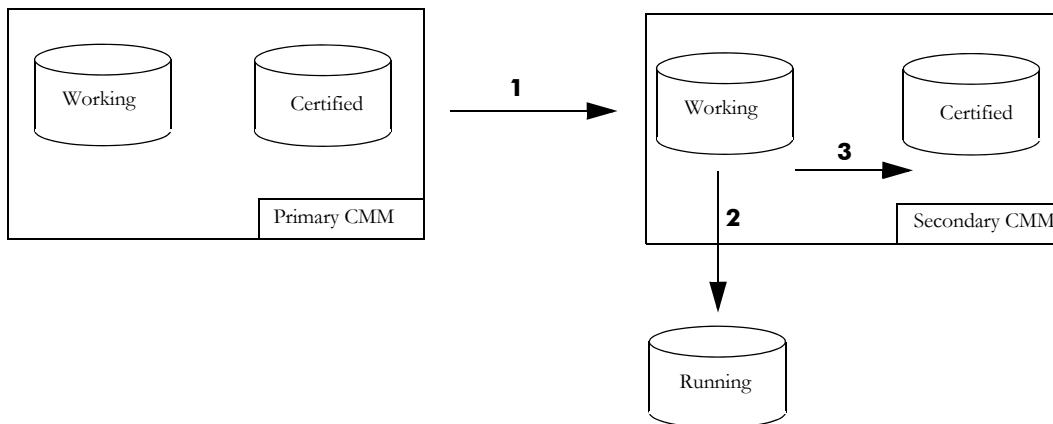

In the above diagram:

- 1** The primary CMM copies its certified directory to the secondary CMM working directory (remember that you cannot copy files directly to the certified directory, they must first be copied to the working directory).
- 2** An automatic reboot is then triggered on the secondary CMM, loading the new contents of the working directory to the running configuration.
- 3** If no problems exist, then the working directory is automatically copied to the certified directory of the secondary CMM.

If the secondary CMM fails to boot properly, then the contents of the secondary CMM's certified directory overwrite the new software on the working directory of the secondary CMM. This causes denying the attempted synchronization process.

This process copies the files in the certified directory of the primary CMM to the certified directory of the secondary CMM. This prevents the secondary CMM from rebooting using incorrect or out-of-date software if the primary CMM goes down.

This command synchronizes all switches in a stack.

To synchronize the secondary CMM to the primary CMM, enter the following command at the prompt:

```
-> copy flash-synchro
```

The **copy flash-synchro** command is described in detail in the *OmniSwitch AOS Release 6 CLI Reference Guide*.

Note. When synchronizing the primary and secondary CMMs, it is important to remember that the **boot.params** file and the switch date and time are not automatically synchronized. See the *OmniSwitch Hardware Guide* for information on the **boot.params** file and information on setting the switch date and time. The date and time are synchronized using the **system time-and-date synchro** command.

Synchronizing the System Date and Time

To synchronize the system date and time, use the **system time-and-date synchro** command. This command synchronizes the secondary CMM date and time to the primary CMM date and time.

Enter the command as shown:

```
-> system time-and-date synchro
```

Swapping the Primary CMM for the Secondary CMM

If the primary CMM is having problems, or if it needs to be shut down, then the secondary CMM can be instructed to “take over” the switch operation as the primary CMM is shut down.

Note. It is important that the software for the secondary CMM has been synchronized with the primary CMM before you initiate a secondary CMM takeover. If the CMMs are not synchronized, the takeover could result in the switch running old or out-of-date software. Synchronizing the primary and secondary CMMs is described in [“Synchronizing the Primary and Secondary CMMs” on page 5-27](#).

To instruct the secondary CMM to takeover switch functions from the primary CMM, enter the following command at the prompt:

```
-> takeover
```

The **takeover** command is described in detail in the *OmniSwitch AOS Release 6 CLI Reference Guide*.

In a stack with three or more switches, the secondary CMM takes over as primary and the original primary becomes “idle.” The next available idle switch becomes the new secondary CMM. For more information on stacks, see the “Managing Stacks” chapter found in the *OmniSwitch AOS Release 6350/6450 Hardware Users Guide*.

Note. The saved **boot.cfg** file is overwritten if the **takeover** command is executed after the **copy running-config working** or **write memory** command on an OmniSwitch 6350, 6450 switch set up with redundant CMMs.

Show Currently Used Configuration

In a chassis with a redundant CMM, the display for the currently running configuration tells the user if the primary and secondary CMMs are synchronized.

To check the directory from where the switch is currently running and if the primary and secondary CMMs are synchronized, enter the following command:

```
->show running-directory

CONFIGURATION STATUS
  Running CMM           : PRIMARY,
  CMM Mode              : DUAL CMMs,
  Current CMM Slot     : 1,
  Running configuration : WORKING,
  Certify/Restore Status : CERTIFY NEEDED
SYNCHRONIZATION STATUS
  Flash Between CMMs      : SYNCHRONIZED,
  Running Configuration   : NOT AVAILABLE,
  Stacks Reload on Takeover: ALL STACKS (SW Activation)
```

The command returns the name of the directory the switch is currently running from (working or certified), and also displays the CMM which is currently controlling the switch (primary or secondary). It also displays whether the working and certified directories are the same and whether a synchronization is needed between the primary and secondary CMM. In addition, the command output displays how many modules in the stack are reloaded in the event of a management module takeover. Options include NONE, ALL, or a list of specific modules. Refer to the following section for additional information on NI module behavior during a redundant CMM takeover.

The **show running-directory** command is described in detail in the *OmniSwitch AOS Release 6 CLI Reference Guide*.

NI Module Behavior During Takeover

If there are no unsaved configuration changes and the flash directories on both the primary and secondary management modules have been synchronized through the **copy flash-synchro** command, no NIs is reloaded if a management module takeover occurs. As a result, data flow is not interrupted on the NIs during the takeover.

If a configuration change is made to one or more NI modules (for example, a VLAN is configured on several different interfaces) and the changes are not saved through the **write memory** command, the corresponding NIs automatically reloads if a management module takeover occurs. Data flow on the affected NIs will be interrupted until the reload is complete. Note that the NIs reloads whether the flash synchronization status shows SYNCHRONIZED. This is because the unsaved changes have occurred in the running configuration (RAM), and have not been written to the configuration file of the flash directory. In this case, a list of only the affected NIs is displayed in the table output (for example, 1 6).

If the flash directories on the primary and secondary management modules are not synchronized (for example, a **copy flash-synchro** command has not been issued recently), all NIs is reloaded automatically if a management module takeover occurs. Data flow is interrupted on all NIs until the reload is complete.

Using the USB Flash Drive

An Alcatel-Lucent certified USB flash drive can be connected to the CMM and used to transfer images to and from the flash memory on the switch. This can be used for upgrading switch code or backing up files. Additionally, automatic code upgrades as well as the capability to boot from the USB flash drive for disaster recovery purposes are also supported. For the automatic upgrades and disaster recovery the USB flash drive must be configured with the proper directory structure, depending on the platform, as noted in the following table. Once the flash drive is properly mounted a directory named */uflash* is automatically created. Files can then be copied to and from the */uflash* directory.

The directories below must be created on the USB flash drive for feature support.

Product Family Name	Auto-Upgrade Support	Disaster-Recovery Support
OmniSwitch 6450	6450/working	6450/certified
OmniSwitch 6350	6350/working	6350/certified

Transferring Files Using USB

The following is an example of how to mount and transfer files using the USB flash drive using the **usb** and **umount** commands.

```
-> usb enable
-> cp /flash/working/boot.cfg /uflash/boot.cfg
-> umount /uflash
```

Once the USB flash drive is mounted most common file and directory commands can be performed on the */uflash* directory.

Automatically Upgrading Code Using USB

The switch can be configured to automatically mount and copy image files from the USB flash drive as soon as it's connected. This can be used to automatically upgrade code. In order to prevent an accidental upgrade, a file named *aossignature* must be stored on the USB flash drive as well as having a directory with the same name as the product family as noted in the table above. The following is an example for an OmniSwitch 6450 using the **usb auto-copy** command

Note: The *aossignature* file can be an empty text file.

- 1 Create a file named *aossignature* in the root of the USB flash drive.
- 2 Create a directory named *6450/working* on the USB flash drive with all the proper image files.
- 3 `-> usb enable`
- 4 `-> usb auto-copy enable`
- 5 Connect the USB flash drive to the CMM. The presence of image files on the USB flash drive is checked and then copied from the USB flash drive directory */uflash/6450/working* to the */flash/working* directory of the CMM. The switch now reboots from the */flash/working* directory applying the code upgrade.
- 6 Once the switch reboots the auto-copy feature is automatically disabled to prevent another upgrade.

Disaster Recovery Using USB

The switch can be recovered from the USB flash drive. This can be used if the image files on the CMM become corrupted, deleted, or the switch is unable to boot from the CMM for other reasons. The following is an example for an OmniSwitch 6450:

- 1** It is recommended to prepare the USB flash drive prior to needing it for disaster recovery.
- 2** Create a directory named *6450/certified* on the USB flash drive with all the proper backup system and configuration files.
- 3** Connect the USB flash drive to the CMM. The CMM flash is reformatted and the images are copied from the USB flash drive directory */uflash/6450/certified* to the */flash/certified* directory of the CMM and the switch reboots from the */flash/certified* directory.
- 4** Now that the switch has been recovered it can be reconfigured as needed.

Note: The OmniSwitch must have a properly working 6.6.4 version of uboot/miniboot to support the Disaster Recovery feature.

If a backup *boot.cfg* file is on the USB flash drive it is copied along with the image files and can be used to recover the switch configuration.

Emergency Restore of the boot.cfg File

If all copies of the **boot.cfg** file have been deleted and a system boot has occurred, network configuration information is permanently lost. However, if the files have been deleted and *no boot has occurred* you can issue a **write memory** command to regenerate the **boot.cfg** file.

Can I Restore the boot.file While Running from Certified?

Yes. While it is not recommended that you routinely save configuration changes while running from the **certified** directory, you can perform an emergency restore of your configuration by following the steps:

1 Copy your current configuration to a manually-generated **boot.cfg** file in the **/flash** directory by entering the following command:

```
-> configuration snapshot all boot.cfg
```

2 Copy the new **boot.cfg** file from the **/flash** directory to the **/flash/working** directory by using the **cp** command. for example:

```
-> cp boot.cfg working/boot.cfg
```

3 Reboot the switch from the **/flash/working** directory by entering the following command:

```
-> reload working no rollback-timeout
```

Once the **boot.cfg** file is confirmed to be good, it has to be saved to the certified directory by using the procedure described in [“Copying the Working Directory to the Certified Directory”](#) on page 5-21.

Checking the Integrity of the Image

To check the integrity of image files in working or certified directory, use the [image integrity-check](#) command.

For example,

```
-> image integrity-check working
HASH for KFsecu.img      : BC077D4A467CA0794E231A841342783793AE48E8
HASH for KFeni.img      : 9E09B914CFCA80333F6405116ADB89DF76A025C4
HASH for KFos.img       : CD1C0743F1EEBF3480677D649F0748FB70FE3A11
HASH for KFdiag.img     : 4CF2A1E394906D40E6DBE6817C66664322B4CAED
HASH for KFbase.img     : 3955CDAA1C49DC50D0B52BE35DA2E5E0769C710D

-> Image integrity-check working hash.txt
Computing the HASH for image files .....
Image integrity check success for KFsecu.img
Image integrity check success for KFeni.img
Image integrity check success for KFos.img
Image integrity check success for KFdiag.img
Image integrity check success for KFbase.img
```

When the command is entered without the filename, the SHA256 hash of the image files in selected directory (working/certified) is calculated and displayed. It can be manually verified against the hash provided in the file.

When the command is entered with the filename, the SHA hash is calculated on the individual image files in the selected directory (working/certified) and compared with the hash information in the file.

Hash value for the images needs to be stored in the *<filename>* in the below format.

KFsecu.img:AE02549EA4D793593AD676F8A49A6522F2C9F4E

KFeni.img:7F95BE32F2F1CB12E31D635AFA873C149551F1EA

Displaying CMM Conditions

To show various **CMM** conditions, such as where the switch is running from and which files are installed, use the following CLI show commands:

show running-directory	Shows the directory from where the switch was booted.
show reload	Shows the status of any time delayed reboot(s) that are pending on the switch.
show microcode	Displays microcode versions installed on the switch.

For more information on the resulting displays from these commands, see the *OmniSwitch AOS Release 6 CLI Reference Guide*. An example of the output for the **show microcode** command is given in “[Show Switch Files](#)” on page 5-24.

6 Using the CLI

Command Line Interface (CLI) is a text-based configuration interface that allows you to configure switch applications and to view switch statistics. Each CLI command applicable to the switch is defined in the *OmniSwitch AOS Release 6 CLI Reference Guide*. All command descriptions listed in the Reference Guide include command syntax definitions, defaults, usage guidelines, example screen output, and release history.

This chapter describes various rules and techniques that help use the CLI to its best advantage. This chapter includes the following sections:

- [“CLI Overview” on page 6-3](#)
- [“Command Entry Rules and Syntax” on page 6-4](#)
- [“CLI Services” on page 6-11](#)
- [“Logging CLI Commands and Entry Results” on page 6-17](#)

CLI Specifications

The following table lists specifications for the Command Line Interface.

Platforms Supported	OmniSwitch 6350, 6450
Configuration Methods	<ul style="list-style-type: none">• Online configuration through real-time sessions using CLI commands.• Offline configuration using text file holding CLI commands.
Command Capture Feature	Snapshot feature captures switch configurations in a text file.
User Service Features	<ul style="list-style-type: none">• Command Line Editing• Command Prefix Recognition• CLI Prompt Option• Command Help• Keyword Completion• Command History (up to 30 commands)• Command Logging (up to 100 commands; detailed information)• Syntax Error Display• Alias Command Option• More Command

CLI Overview

The CLI uses single-line text commands that are similar to other industry standard switch interfaces. However, the Alcatel-Lucent CLI is different from industry standard interfaces in that the Alcatel-Lucent uses a single level command hierarchy.

Unlike other switch interfaces, the Alcatel-Lucent CLI has no concept of command modes. Other CLIs require you to step your way down a tree-type hierarchy to access commands. Once you enter a command mode, go back to the top of the hierarchy before you enter a command in a different mode. The Alcatel-Lucent switch answers any CLI command at any time because there is no hierarchy.

Online Configuration

To configure parameters and view statistics, connect the switch to a terminal, such as a PC or UNIX workstation, using terminal emulation software. This connection can be made directly to the serial port of the switch through a modem, or over a network through Telnet. For information about connecting a terminal to the switch, see the *OmniSwitch AOS Release 6350/6450 Hardware Users Guide*.

Note. If you are using an OmniSwitch 6350, 6450 switch in a stacked configuration, you must be connected to the console port of the primary switch. For detailed information on primary switch status, refer to the *OmniSwitch AOS Release 6350/6450 Hardware Users Guide*.

Once you are logged in to the switch, configure the switch directly using CLI commands. Commands executed in this manner normally take effect immediately. The majority of CLI commands are independent, single-line commands and therefore can be entered in any order. However, some functions require you to configure specific network information before other commands can be entered. For example, before you can assign a port to a VLAN, first create the VLAN. For information about CLI command requirements, refer to the *OmniSwitch AOS Release 6 CLI Reference Guide*.

Offline Configuration Using Configuration Files

CLI configuration commands can be typed into a generic text file. When the text file is placed in the switch `/flash/working` directory, its commands are applied to the switch when the **configuration apply** command is issued. Files used in this manner are called configuration files.

A configuration file can be viewed or edited offline using a standard text editor. It can then be uploaded and applied to additional switches in the network. This allows you to clone switch configurations easily. This ability to store comprehensive network information in a single text file facilitates troubleshooting, testing, and overall network reliability.

See [Chapter 7, “Working With Configuration Files,”](#) for detailed information about configuration files.

Command Entry Rules and Syntax

When you start a session on the switch, you can execute CLI commands as soon as you are logged in. The following rules apply:

- Enter only one command per line.
- No command can be extended across multiple lines.
- Passwords are case sensitive.
- Commands are *not* case sensitive. The switch accepts commands entered in upper case, lower case, or a combination of both.
- Press Enter to complete each command line entry.
- To use spaces within a user-defined text string, enclose the entry in quotation marks (“ ”).
- If you receive a syntax error (that is, ERROR: Invalid entry:), double-check your command as written and re-enter it exactly as described in the *OmniSwitch AOS Release 6 CLI Reference Guide*. Be sure to include all syntax option parameters.
- To exit the CLI, type **exit**, and press Enter.

Text Conventions

The following table contains text conventions and usage guidelines for CLI commands as they are documented in this manual.

bold text	Indicates basic command and keyword syntax. Example: show snmp station
“ ” (Quotation Marks)	Used to enclose text strings that contain spaces Example: vlan 2 name “new test vlan”

Using “Show” Commands

The CLI contains **show** commands that allow you to view configuration and switch status on your console screen. The **show** syntax is used with other command keywords to display information pertaining to those keywords.

For example, the **show vlan** command displays a table of all VLANs currently configured, along with pertinent information about each VLAN. Different forms of the **show vlan** command can be used to display different subsets of VLAN information. For example the **show vlan rules** command displays all rules defined for a VLAN.

Using the “No” Form

The *OmniSwitch AOS Release 6 CLI Reference Guide* defines all CLI commands and explains their syntax. Whenever a command has a “no” form, it is described on the same page as the original command.

The “no” form of a command can be used for the following:

- Remove the configuration created by a command. For example, create a VLAN with the **vlan** command, and delete a VLAN using the **no vlan** command.
- Reset a configuration value to its default. For example, create a static IGMP entry on a specified port of a specified VLAN with the **ip multicast static-group** command. You can remove the static IGMP entry from a specified port on a specified VLAN with the **no ip multicast static-group** command.

Using “Alias” Commands

Define substitute text for the CLI commands in the switch by using the **alias** command.

There are two main reasons for defining aliases:

- To eliminate excess typing by reducing the number of characters required for a command.

To reduce the number of characters required to use the **group** term in a CLI command, you can change the syntax to **gp** as follows:

```
-> alias gp group
```

- To change unfamiliar command words into familiar words or patterns.

If you prefer the term “privilege” to the term “attribute” with reference to the read-write capabilities of a login account, you can change the CLI word from **attrib** to **privilege** by using the following command.

```
-> alias privilege attrib
```

After an alias has been defined, both the alias and the original CLI term are supported as valid CLI terms. For example if **privilege** is defined as an alias as shown above, both **privilege** and **attrib** work as CLI commands and both words are shown when you use the CLI help feature.

You can save command aliases for the current user account by executing the **user profile save** command. If the aliases are not saved they are stored until the user session ends. In this case, once you log off the switch, substitute terms configured with the **alias** command are destroyed.

To display aliases, use the **show alias** command. To set all alias values back to their factory defaults, use the **user profile reset** command.

Partial Keyword Completion

The CLI has a partial keyword recognition feature that allows the switch to recognize partial keywords to CLI command syntax. Instead of typing the entire keyword, type only as many characters as is necessary to identify the *keyword* uniquely, then press the Tab key. The CLI completes the keyword and place the cursor at the end of the keyword.

When you press Tab to complete a command keyword, one of four things can happen:

- You enter enough characters (prior to Tab) to identify the command keyword uniquely.

In this case, pressing Tab causes the CLI to complete the keyword and place a space followed by the cursor at the end of the completed keyword.

- You do not enter enough characters (prior to Tab) to identify the command keyword uniquely.

In this case pressing Tab has no effect.

- You enter characters that do not belong to a keyword that can be used in this instance.

In this case, pressing Tab removes the characters and place the cursor back to its previous position.

- You enter enough characters (prior to Tab) to identify a group of keywords uniquely such that all keywords in the group share a common prefix.

In this case, pressing Tab causes the CLI to complete the common prefix and place the cursor at the end of the prefix. In this case, no space is placed at the end of the keyword.

Note. The keyword completion feature accepts wildcards.

CLI Auto Completion

The space key can be used for auto completion of the CLI command similar to TAB key. If the space key is pressed, auto-completion will complete the keyword.

When you enter an incorrect keyword, pressing space key will not remove the keyword whereas pressing the TAB key will remove the keyword while attempting auto-completion.

Use the command [session cli-auto-complete-space enable](#) to enable this feature.

Command Help

The CLI has an internal help feature you can invoke by using the question mark (?) character as a command. The CLI help feature provides progressive information on how to build your command syntax, one keyword at a time.

If you do not know the first keyword of the command you need, you can use a question mark character at the CLI system prompt. The CLI responds by listing command keywords divided into command sets. You can find the first keyword for the command you need by referring to the list on your screen. The following is a partial display:

```
-> ?
  WHOAMI WHO VIEW VI VERBOSE USER UPDATE TTY TELNET6 TELNET SYSTEM SWLOG SSH6
  SSH SHOW SFTP6 SFTP SESSION RZ RMDIR RM RENAME PWD PROMPT NTP NSLOOKUP NO NEWFS
  MV MOVE MORE MODIFY MKDIR LS KILL IP INSTALL HISTORY FTP FSCK FREESPACE EXIT
  DSHELL DIR DELETE DEBUG CP COMMAND-LOG CHMOD CD AUTO ATTRIB ALIAS
  (System Service & File Mgmt Command Set)
```

(Additional output not shown)

The command keywords are shown in all capital letters. The name of the command set is listed parenthetically *below* the keywords in initial caps.

The following table contains the first-level commands and their set names as they are listed on the display screen when you enter a single question mark and press Enter.

Command Set Name	Commands
System Service & File Management	WHOAMI, WHO, VIEW, VI, VERBOSE, USER, UPDATE, TTY, TELNET6, TELNET, SYSTEM, SWLOG, SSH6, SSH, SHOW, SFTP6, SFTP, SESSION, RZ, RMDIR, RM, RENAME, PWD, PROMPT, NTP, NSLOOKUP, NO, NEWFS, MV, MOVE, MORE, MODIFY, MKDIR, LS, KILL, IP, HISTORY, FTP, FSCK, FREESPACE, EXIT, DSHELL, DIR, DELETE, DEBUG, CP, COMMAND-LOG, CHMOD, CD, AUTO, ATTRIB, ALIAS
CMM Chassis Supervision	COPY, WRITE, POWER, TEMP-THRESHOLD, TAKEOVER, SYSTEM, SHOW, RRM, RPUT, RLS, RGET, RELOAD, RDF, RCP, NO, DEBUG, CONFIGURE
Source Learning	SOURCE-LEARNING, SHOW, PORT-SECURITY, NO, MAC-ADDRESS-TABLE, DEBUG
Spanning Tree	SHOW, BRIDGE
VLAN	VLAN, SHOW, NO, MAC-ADDRESS-TABLE, DEBUG
Link Aggregation	STATIC, SHOW, NO, LINKAGG, LACP
Miscellaneous	HTTP, TRACEROUTE, SNMP, SHOW, RMON, PORT, POLICY, PING, NO, MAC-RANGE, MAC, LANPOWER, IP, IPV6, ICMP, HTTPS, HRE, HEALTH, GMAP, DEBUG, CLEAR, ARP, AMAP, 802.1X
AAA & Configuration Manager	USER, SHOW, PASSWORD, NO, END-USER, DEBUG, CONFIGURATION, AAA
Interface	TRAP, SHOW, NO, INTERFACES, FLOW, DEBUG, 10GIG

Command Set Name	Commands
IP Routing & Multicast	DEBUG, TRACEROUTE6, SHOW, PING6, NO, IPV6, IP, CLEAR
QoS	SHOW, QOS, POLICY, NO, DEBUG
Debug	UPDATE, SHOW, NO, DEBUG

Tutorial for Building a Command Using Help

The Help feature allows you to figure out syntax for a CLI command by using a series of command line inquiries together with some educated guesses. If you do not know the correct CLI command you can use the Help feature to determine the syntax.

This tutorial shows you how to use `help` to find the CLI syntax to create a VLAN. This VLAN will be given the ID number 33 and will be named “test vlan 2.”

1 At the command prompt, enter `vlan` followed by a space and a question mark. The following is displayed:

```
-> vlan ?
      ^
      PORT NO IPMVLAN 802.1Q <vid> <vlan1-vlan2>
      (Vlan Command Set)
```

The question mark character invokes the help feature, which displays keywords that can be used with the `vlan` prefix. As you are setting up a new VLAN, you can presume the proper command for this task is shown in the VLAN Manager Command Set. This set shows the possible keywords to follow the `vlan` syntax.

Note. The presumptions you make while using the help feature are educated guesses. Whenever you make a guess as to the next keyword, it is a good idea to enter the keyword followed by a space and a question mark.

2 At the command prompt, enter the number `33` followed by a space and a question mark. This step either gives you more choices or an error message.

```
-> vlan 33 ?
      ^
      <cr> AUTHENTICATION DISABLE ENABLE NAME NO PORT ROUTER STP
      (Vlan Manager Command Set)

      BINDING DHCP IP MAC NO PORT PROTOCOL USER
      (Group Mobility Command Set)

      802.1Q NO
      (Miscellaneous Command Set)
```

In this example, the question mark displays all keywords that can be used with the `vlan 33` syntax. As you are setting up a new VLAN, and want to give the VLAN a *name*, you can presume the proper syntax for this task is `NAME` as shown in the VLAN Manager Command Set.

3 At the command prompt, enter **name** followed by a space and a question mark. This step either gives you more choices or an error message.

```
-> vlan 33 name ?
      ^
      <hex> <"string"> <string>
(Vlan Manager Command Set)
```

There is a smaller set of keywords available for use with the **vlan 33 name** syntax. This is because the command becomes more specialized as more keywords are added. From the choices shown on the screen, you can enter a hex value, a text string enclosed in quotes (“ ”) or a text string without quotes. In this case, the name selected for the VLAN includes spaces so use the syntax enclosed in quotes.

4 At the command prompt, enter the name of the VLAN enclosed in quotes, followed by a space and a question mark.

```
-> vlan 33 name "test vlan 2" ?
      ^
      <cr>
(Vlan Manager Command Set)
```

When the question mark is issued this time, the only syntax listed is <cr>. This means that the command syntax is complete. When you press Enter, the command is issued.

Note. Optional. To verify that the command was accepted, enter the **show vlan** command. The display is similar to the one shown here.

```
-> show vlan
vlan  admin   oper   stree  auth   ip   name
-----+-----+-----+-----+-----+-----+-----
   1    on     off    on     off   off  VLAN 1
  33    on     off    on     off   off  test vlan 2
```

The second entry verifies that a VLAN was created, the VLAN ID is 33, and the name is test vlan 2.

CLI Services

There are several services built into the CLI that help you use the interface. The Command Line Editing service makes it easy for you to enter and edit repetitive commands. Other CLI services, such as syntax checking, command help, prefix prompt, and history assist you in selecting and using the correct command syntax for the task you are performing.

Command Line Editing

CLI commands are entered from your keyboard and are executed when you press Enter. The CLI also has several editing features that make it easier for you to enter the correct commands, either by allowing you to correct entry mistakes or by helping you enter the correct command.

Deleting Characters

You can delete CLI command characters by using the Backspace key or the Delete key. The Backspace key deletes each character in the line, one at a time, from right to left. Note the following command entry:

```
-> show macrocode
```

The correct syntax is “show microcode”. To change the spelling in this entry, use the Backspace key to delete all of the characters after the “m”.

```
-> show m
```

Type the correct syntax, then press Enter to execute the command.

To change incorrect syntax with the Delete key, use the Left Arrow key to move the cursor to the left of the character to be deleted, then use the Delete key to remove characters to the right of the cursor. Note the following command entry:

```
-> show macrocode
```

The correct syntax is “show microcode”. To change the spelling in this entry, use the Left Arrow key to place the cursor between the “m” and the “a”.

```
-> show m |acrocode
```

Use the Delete key to remove the “a” and type “i”.

```
-> show microcode
```

Press Enter to execute the command.

Recalling the Previous Command Line

To recall the last command executed by the switch, press either the Up Arrow key or the **!!** (bang, bang) command at the prompt and the previous command is displayed on your screen. You can execute the command again by pressing Enter or you can edit it first by deleting or inserting characters.

In the following example, the **ls** command is used to list the contents of the **/flash/switch** directory of the switch.

```
-> ls

Listing Directory /flash/switch:

drw      2048 Jan  1  1980 ./
drw      2048 Jan  3 19:23 ../
-rw       308 Jan  1  1980 banner_default.txt

          9850880 bytes free

->
```

To enter this same command again, use the Up Arrow key. The **ls** command appears at the prompt. To issue the **ls** command, press Enter.

```
-> ls
```

The Up Arrow key and the **!!** (bang, bang) command displays the last command line entered even if the command was rejected by the switch.

For more details on using the **!!** command, refer to [“Command History” on page 6-15](#).

Inserting Characters

To insert a character between characters already typed, use the Left and Right Arrow keys to place the cursor into position, then type the new character. Once the command is correct, execute it by pressing Enter. In the following example, the user enters the wrong syntax to execute the **show microcode** command. The result is an error message.

```
-> show microcode
ERROR: flash: no such directory
```

To correct the syntax without retyping the entire command line, use the **!!** command to recall the previous syntax. Then, use the Left Arrow key to position the cursor between the “r” and the “c” characters. To insert the missing character, type “o”.

```
-> !!
-> show microcode
```

To execute the corrected command, press Enter.

Syntax Checking

If you make a mistake while entering command syntax, the CLI gives you clues about how to correct your error. Whenever you enter an invalid command, two indicators are displayed.

- The Error message tells you *what* the error is.
- The caret (^) character tells you *where* the error is in your syntax.

The following example of the syntax checking feature shows an attempt to set IP routing. If you enter the command **set ip routing**, the following is displayed:

```
-> set ip routing enable
    ^
ERROR: Invalid entry: "set"
```

The **set ip routing** command is not valid so the CLI error message states what the problem is (Invalid entry) and the carat indicates where the problem is located in the syntax. Here, the problem is with the “set” keyword so the carat is located under “set”. The error message states the nature of the problem—that “set” is an invalid entry. To enable IP routing, find another command keyword because **set** is not valid.

Prefix Recognition

Prefix Recognition is a CLI feature that reduces redundant command line entry by storing prefix information for certain network commands.

When you configure network services, you might have to enter the same command prefix multiple times. Entering the same prefix multiple times can be cumbersome and prone to error. The prefix recognition feature addresses the problem of redundant command entry by allowing the CLI to store commonly used prefix information. This prefix information stored by the switch then becomes part of the next CLI command entered.

The following command families support the prefix recognition feature:

- AAA
- Interface
- Link Aggregation
- QOS
- Spanning Tree
- VLAN Management

When certain commands are entered from one of these families, the CLI retains the prefix information in a memory buffer. Then, if a valid related command is entered next, the CLI assumes the stored prefix is part of the next command. In this case, you are only required to enter the suffix information for the next command.

Example for Using Prefix Recognition

This example shows how the Prefix Recognition feature is used for entering multiple commands that have the same prefix. This table lists the tasks to be accomplished in this example and the CLI syntax required for each task.

Task	CLI Syntax
1. Create a VLAN with an identification number of 501.	vlan 501 enable
2. Enable the spanning tree protocol for VLAN 501.	vlan 501 stp enable
3. Enable authentication for VLAN 501.	vlan 501 authentication enable

To create VLAN 501 and configure its attributes using the CLI commands, you could enter the **vlan 501** prefix three times. However, VLAN commands support the prefix recognition capability so redundant entry of this *prefix* is not necessary.

For example, when you enter

```
-> vlan 501 enable
```

The CLI automatically stores the prefix **vlan 501**. Now, if you enter a related command for the same VLAN, you are only required to enter suffix information. In this case, you can enter the commands to accomplish tasks 2, and 3 as follows:

```
-> stp enable
-> authentication enable
```

Prefix information is remembered by the CLI until you enter a command with a new prefix.

Note. If you want to create or configure another VLAN, reenter the full command prefix, including the new VLAN ID.

Show Prefix

You can view the current prefix by issuing the **show prefix** command. If you issue this command when the prefix stored by the CLI is **vlan 501**, the following is displayed:

```
-> show prefix
Current prefix: vlan 501
```

If you issue the **show prefix** command when there is no prefix stored by the CLI, a “no prefix” message is displayed.

Prefix Prompt

You can set the CLI so that your screen prompt displays the stored prefix. To display the stored prefix as part of the screen prompt for the VLAN example above, enter the **prompt prefix** CLI command as follows:

```
-> prompt prefix
```

The following is displayed:

```
-> vlan 501
```

Your screen prompt includes your stored prefix until a new prompt is specified. To set the prompt back to the arrow (->) enter the **prompt string ->** (prompt string arrow) syntax as follows:

```
-> vlan 501 prompt string ->
->
```

The arrow displays to indicate that your prompt has changed back to the default.

For more general information about changing the prompt, refer to [“Changing the CLI Prompt” on page 6-19](#).

Command History

The **history** command allows you to view commands you have recently issued to the switch. The switch has a history buffer that stores up to 30 of the most recently executed commands.

Note. The **command history** feature differs from the **command logging** feature in that command logging stores up to 100 of the most recent commands in a separate **command.log** file. Also, the command logging feature includes additional information, such as full command syntax, login user name, entry date and time, session IP address, and entry results. For more information on command logging, refer to [“Logging CLI Commands and Entry Results” on page 6-17](#).

You can display the commands in a numbered list by using the **show history** command. The following is a sample list:

```
-> show history
1 show cmm
2 show fan
3 show sensor
4 show temp
5 show arp
6 clear arp
7 show ip config
8 ip helper max hops 5
9 ip bgp pn
10 show ip bgp
11 show history
```

In the example above, the **show history** command is listed last because it is the command that was executed most recently.

You can recall commands shown in the history list by using the exclamation point character (!) also called “bang”. To recall the command shown in the history list at number 4, enter **!4** (bang, 4). The CLI responds by printing the number four command at the prompt. Using the history list of commands above, the following would display:

```
-> !4
-> show temp
```

You can recall the last command in the history list by issuing the **!!** (bang bang) syntax. The CLI responds by printing the last command in the history list (**show history**) at the prompt as shown here.

```
-> !!
-> show history
```

Note. When you use **!n** or **!!** to recall a command in the history list, press the Enter key to execute the command.

You can configure the number of history commands saved by the switch for display by the show history command. The range for the **history size** value is 1 to 30. To view the history parameters, use the **show history parameters** command.

```
-> history size 30
-> show history parameters
History size: 30
CurrentSize: 10
Index Range: 1-10
```

The values in this display are defined here:

- **History Size:** The number of commands the switch will save for display by the **show history** command.
- **Current Size:** The number of commands currently saved by the switch, ready for display by the **show history** command.
- **Index Range:** This value indicates the index range of the commands for this CLI session currently stored in the history buffer.

In the above example, the switch is set to display 30 commands. However, when the **show history parameters** command was issued, only ten commands had yet been issued. Since only ten commands had been issued during the current login session, the index range shows 1 to 10. This is because the commands in the buffer are the first through the tenth commands issued during the current login session.

Note. The Partial Keyword Completion feature described on [page 6-6](#) works within the CLI history buffer.

Logging CLI Commands and Entry Results

The switch provides command logging through the **command-log** command. This feature allows users to record up to 100 of the most recent commands entered through Telnet, Secure Shell, and console sessions. In addition to a list of commands entered, the results of each command entry are recorded. Results include information such as whether a command was executed successfully, or whether a syntax or configuration error occurred.

Note. The **command history** feature differs from the **command logging** feature in that command history buffers up to 30 of the most recent commands. The command information is *not* written to a separate log file. Also, the command history feature includes only general keyword syntax (that is, it does not record full syntax, date and time, session IP address, and entry results). For more information on command history, refer to [page 6-15](#).

Refer to the sections below for more information on configuring and using CLI command logging. For detailed information related to command logging commands, refer to the *OmniSwitch AOS Release 6 CLI Reference Guide*.

Enabling Command Logging

By default, command logging is *disabled*. To enable command logging on the switch, enter the following command:

```
-> command-log enable
```

When command logging is enabled through the **command-log enable** syntax, a file called **command.log** is automatically created in the **flash** directory of the switch. Once enabled, configuration commands entered on the command line are recorded to this file until command logging is disabled.

The **command.log** file has a 66402-byte capacity. This capacity allows up to 100 of the most recent commands to be recorded. Because all CLI command logging information is archived to the **command.log** file, command history information is lost if the file is deleted.

Note. The **command.log** file cannot be deleted while the command logging feature is enabled. Before attempting to remove the file, be sure to disable command logging. To disable command logging, refer to the information below.

Disabling Command Logging

To disable the command logging, simply enter the following command:

```
-> command-log disable
```

Disabling command logging *does not* automatically remove the **command.log** file from the **flash** directory. All commands logged *before* the **command-log disable** syntax was entered remains available for viewing. For information on viewing logged commands, along with the command entry results, refer to [“Viewing Logged CLI Commands and Command Entry Results” on page 6-18](#).

Viewing the Current Command Logging Status

As mentioned above, the command logging feature is disabled by default. To view whether the feature is currently enabled or disabled on the switch, use the **show command-log status** command. For example:

```
-> show command-log status
CLI command logging: Enable
```

In this case, the feature has been enabled by the user through the **command-log** command. For more information on enabling and disabling command logging, refer to the sections above.

Viewing Logged CLI Commands and Command Entry Results

To view a list of logged commands, along with the corresponding information (including entry results), enter the **show ssh config** command. For example:

```
-> show command-log
Command : ip interface vlan-68 address 168.14.12.120 vlan 68
  UserName : admin
  Date      : MON APR 28 01:42:24
  Ip Addr   : 128.251.19.240
  Result    : SUCCESS

Command : ip interface vlan-68 address 172.22.2.13 vlan 68
  UserName : admin
  Date      : MON APR 28 01:41:51
  Ip Addr   : 128.251.19.240
  Result    : ERROR: Ip Address must not belong to IP VLAN 67 subnet

Command : ip interface vlan-67 address 172.22.2.12 vlan 67
  UserName : admin
  Date      : MON APR 28 01:41:35
  Ip Addr   : 128.251.19.240
  Result    : SUCCESS

Command : command-log enable
  UserName : admin
  Date      : MON APR 28 01:40:55
  Ip Addr   : 128.251.19.240
  Result    : SUCCESS
```

The **show command-log** command lists up to 100 CLI commands in *descending order*. In other words, the most recent commands are listed first. In the example above, the **command-log enable** syntax is the least recent command logged; the **ip interface vlan-68 address 168.14.12.120 vlan 68** syntax is the most recent.

- **Command.** Shows the exact syntax of the command, as entered by the user.
- **UserName.** Shows the name of the user session that entered the command. For more information on different user session names, refer to [Chapter 9, “Managing Switch User Accounts.”](#)
- **Date.** Shows the date and time, down to the second, when the command was originally entered.
- **IP Addr.** The IP address of the terminal from which the command was entered.
- **Result.** The outcome of the command entry. If a command was entered successfully, the syntax **SUCCESS** displays in the Result field. If a syntax or configuration error occurred at the time a command was entered, details of the error display. For example:

```
Result    : ERROR: Ip Address must not belong to IP VLAN 67 subnet
```

Customizing the Screen Display

The CLI has several commands that allow you to customize the way switch information is displayed to your screen. You can make the screen display smaller or larger. You can also adjust the size of the table displays and the number of lines shown on the screen.

Note. Screen display examples in this chapter assume the use of a VT-100/ASCII emulator.

Changing the Screen Size

Specify the size of the display shown on your terminal screen by using the **tty** command. This command is useful when you have a small display screen or you want to limit the number of lines scrolled to the screen at one time. For example, to limit the number of lines to 10 and the number of columns to 150, enter the following:

```
-> tty 10 150
```

The first number entered after **tty** defines the number of lines on the screen. It must be a number between 10 and 150. The second number after **tty** defines the number of columns on the screen. It must be a number between 20 and 150. View the current setting for your screen by using the **show tty** command.

Changing the CLI Prompt

You can change the system prompt that displays on the screen when you are logged in to the switch. The default prompt consists of a dash, greater-than (->) text string. To change the text string that defines the prompt from -> to ##=> use the **session prompt default** command as follows:

```
->
-> session prompt default ##=>
##=>
```

The switch displays the new prompt string after the command is entered.

Several building blocks are provided that can automatically display system information along with the prompt string. You can set a switch to display any combination of the current username, system time, system date, and system prefix along with the prompt string. The following command defines the prefix to display the system time and date along with the prompt string defined in the above example:

```
-> prompt time date string ##=>
01:31:01 04/29/02##=>
```

For an example of using a stored prefix as part of the prompt, refer to [“Prefix Prompt” on page 6-15](#).

Setting Session Prompt as System Name

CLI prompt can be configured as the current system name of the switch. By default, the system name is set to 'VxTarget'. This can be configured using the command **session prompt default system-name**. Every time the system name is modified, the prompt also gets modified. The new prompt takes effect after relogging to a new session.

Note. System name is configured for the switch using the CLI command **system name**. The system name can also be dynamically obtained from the DHCP server (DHCP Option-12). The user-defined system name configuration (through CLI, WebView, SNMP) gets priority over the DHCP server values.

For more information on the **session prompt default** command, refer to the *OmniSwitch AOS Release 6 CLI Reference Guide*.

Displaying Table Information

The amount of information displayed on your console screen can be extensive, especially for certain **show** commands. By default, the CLI immediately scrolls all information to the screen. The more mode can be used to limit the number of lines displayed to your screen. To use the more mode requires two steps as follows:

- Specify the number of lines displayed while in the more mode.
- Enter the more mode.

The **more size** command specifies the number of lines displayed to the screen while in the more mode. The following syntax sets the switch to display six lines of data to the screen while in the CLI is in more mode.

```
-> more size 6
```

The following command enables the more feature.

```
-> more
```

After these commands are executed, the CLI displays no more than six lines to the screen at a time followed by the **More?** prompt. The following is a sample display.

```
-> show snmp mib family
MIB ID      MIB TABLE NAME                                FAMILY
-----+-----+-----+-----+-----+-----+-----+-----+-----+-----+
6145      esmConfTrap                                    NO SNMP ACCESS
6146      alcetherStatsTable                             interface
6147      esmConfTable                                   interface
More? [next screen <sp>, next line <cr>, filter pattern </>, quit <q>]
```

At the **More?** prompt, you are given a list of options. The output formats are described here:

<sp>	Press <sp> (space bar) to display the next page of information.
<cr>	Press <cr> (character return) to display the next line of information
/	Press / to enter the filter mode. (See “Filtering Table Information” on page 6-21.)
<q>	Press the character “q” to exit More? and return you to the system prompt.

To exit the more mode, use the **no more** CLI command.

Note. The value set with the **more size** command applies to the screen display when the CLI is in the more mode or when you are using the Vi text editor of the switch.

Filtering Table Information

The CLI allows you to define filters for displaying table information. This is useful in cases where a vast amount of display data exists but you are interested in only a small subset of that data. Commands showing routing tables are a good example to filter information. You can specify a filter that identifies the data that are relevant to your search. The switch then displays the information you identified. This saves you the trouble of scanning long lists of data unnecessarily.

The filter mode filters unwanted information from a CLI table by displaying only those lines containing a specified text pattern (up to 80 characters). Once the filter command has been executed, the filter mode remains active until you reach the end of the CLI table or until you exit the table by using the **q** command.

The filter command is case sensitive. When using the slash (/) command, type the text exactly as it would appear in the CLI table.

For additional information about filtering, refer to [“Using a Wildcard to Filter Table Information” on page 6-25](#).

Multiple User Sessions

Several CLI commands give you information about user sessions that are currently operating on the OmniSwitch, including your own session. These commands allow you to list the number and types of sessions that are currently running on the switch. You can also terminate another session, provided you have administrative privileges.

Listing Other User Sessions

The **who** command displays all users currently logged into the OmniSwitch. The following example shows use of the **who** command and a resulting display:

```
-> who
Session number = 0
  User name   = (at login),
  Access type = console,
  Access port = Local,
  IP address  = 0.0.0.0,
  Read-only rights   = 0x00000000 0x00000000,
  Read-Write rights  = 0x00000000 0x00000000,
  Read-only domains  = None,
  Read-only families = ,
  Read-Write domains = None,
  Read-Write families = ,
Session number = 1
  User name   = admin,
  Access type = http,
  Access port = NS,
  IP address  = 123.251.12.51,
  Read-only rights   = 0x00000000 0x00000000,
  Read-Write rights  = 0xffffffff 0xffffffff,
  Read-only domains  = None,
  Read-only families = ,
  Read-Write domains = All ,
  Read-Write families = ,
Session number = 3
  User name   = admin,
  Access type = telnet,
  Access port = NI,
  IP address  = 123.251.12.61,
  Read-only rights   = 0x00000000 0x00000000,
  Read-Write rights  = 0xffffffff 0xffffffff,
  Read-only domains  = None,
  Read-only families = ,
  Read-Write domains = All ,
  Read-Write families = ,
```

The above display indicates that three sessions are currently active on the OmniSwitch. Session number 0 always shows the console port whenever that port is active and logged in. The other sessions are identified by session number, user name, the type of access, port type, IP address, and user privileges. The output definitions are defined in the table on [page 6-23](#).

Listing Your Current Login Session

To list information about your current login session, use the **who** command and identify your login by your IP address or enter the **whoami** command. The following is displayed:

```
-> whoami
Session number = 4
  User name     = admin,
  Access type   = telnet,
  Access port   = NI,
  IP address    = 148.211.11.02,
  Read-only domains = None,
  Read-only families = ,
  Read-Write domains = All ,
  Read-Write families = ,
  End-User profile =
```

This display indicates that the user is currently logged in as session number 4, under the user name “admin,” using a Telnet interface, from the IP address of 148.211.11.02.

Session Number	The session number assigned to the user.
User name	User name.
Access type	Type of access protocol used to connect to the switch.
Access port	Switch port used for access during this session.
Ip Address	User IP address.
Read-only domains	The command domains available with the read-only access of the user. See the table beginning on page 6-24 for a listing of valid domains.
Read-only families	The command families available with the read-only access of the user. See the table beginning on page 6-24 for a listing of valid families.
Read-Write domains	The command domains available with the read-write access of the user. See the table beginning on page 6-24 for a listing of valid domains.
Read-Write families	The command families available with the read-write access of the user. See the table beginning on page 6-24 for a listing of valid families.

Possible values for command domains and families are listed here:

domain	families
domain-admin	file telnet debug
domain-system	system aip snmp rmon webmgt config
domain-physical	chassis module interface pmm health
domain-network	ip rip ip-routing ipmr ipms rdp ipv6
domain-layer2	vlan bridge stp 802.1q linkagg ip-helper
domain-service	dns
domain-policy	qos policy slb
domain-security	session aaa

Terminating Another Session

If you are logged in with administrative privileges you can terminate the session of another user by using the **kill** command. The following command terminates the login session number 4.

```
-> kill 4
```

The command syntax requires you to specify the number of the session you want to kill. You can use the **who** command for a list of all current user sessions and their numbers. The **kill** command takes effect immediately.

Application Example

Using a Wildcard to Filter Table Information

The wildcard character allows you to substitute the asterisk (*) character for text patterns while using the filter mode.

Note. Type the wildcard character in front of and after the filter text pattern unless the text pattern appears alone on a table row.

In this example, the `show snmp mib family` command is used because it displays a long table of MIB information. This example uses the filter option to display only those lines containing the “vlan” character pattern.

- 1 Use the `more` command to set the number of displayed lines to 10 and to enable the more mode.

```
-> more size 10
-> more
```

To verify your settings, enter the following:

```
-> show more
The more feature is enabled and the number of line is set to 10
```

- 2 Enter the `show snmp mib family` command. Ten lines of information are displayed. The switch is now in the **More?** mode as indicated at the bottom of the screen.

```
-> show snmp mib family
MIB ID      MIB TABLE NAME      FAMILY
-----+-----+-----
 6145      esmConfTrap           NO SNMP ACCESS
 6146      alcetherStatsTable    interface
 6147      esmConfTable          interface
 6148      ifJackTable           interface
 7169      dot1qPortVlanTable    802.1Q
 7170      qAggregateVlanTable   802.1Q
 7171      qPortVlanTable        802.1Q
```

```
More? [next screen <sp>, next line <cr>, filter pattern </>, quit <q>]
```

- 3 Type the filter pattern “/” command and the following message automatically appears.

Enter filter pattern:

Enter the desired text pattern, in this case “*vlan*”, at the prompt. Remember to type the text exactly as it would appear in the CLI table and to type the asterisk (*) character before and after the text. The More? mode prompt automatically re-appears.

```
Enter filter pattern: *vlan*
More? [next screen <sp>*, next line <cr>*, filter pattern </>*, quit <q>]
```

4 Press the spacebar <sp> key to execute the filter option. The following is displayed.

```
Enter filter pattern: *vlan*
 8193 dot1qBase                vlan
 8194 dot1qVlan                vlan
 8195 dot1qVlanCurrentTable    vlan
 8196 dot1qVlanStaticTable     vlan
 8197 vlanMgrVlanSet           vlan
 8198 vlanTable                vlan
 8199 vpaTable                 vlan
 9217 vCustomRuleTable         vlan
 9218 vDhcpGenericRuleTable    vlan
 9219 vDhcpMacRuleTable        vlan
More? [next screen <sp>*, next line <cr>*, filter pattern </>*, quit <q>]
```

The screen displays ten table rows, each of which contain the text pattern “vlan”. Alcatel-Lucent CLI uses a single level command hierarchy. (The screen rows shown above and below the table are not counted as part of the 10 rows.) If you want to display the rows one line at a time, press Enter instead of the space bar key. To exit the table, type the “q” character and the CLI exits the **more** mode and return you to the system prompt.

Verifying CLI Usage

To display information about CLI commands and the configuration status of your switch, use the **show** commands listed here:

show session config	Displays session manager configuration information (for example, default prompt, banner file name, inactivity timer, login timer, login attempts, and CLI console shell status).
show alias	Lists all current commands defined by the use of the alias CLI command.
show prefix	Shows the command prefix (if any) currently stored by the CLI. Prefixes are stored for command families that support the prefix recognition feature.
show history	Displays commands you have recently issued to the switch. The commands are displayed in a numbered list.
show more	Shows the enable status of the more mode along with the number of lines specified for the screen display.

For more information about the resulting displays from these commands, see the *OmniSwitch AOS Release 6 CLI Reference Guide*. Additional information can also be found in [“Using “Show” Commands” on page 6-5](#).

7 Working With Configuration Files

Commands and settings needed for the OmniSwitch can be contained in an ASCII-based configuration text file. Configuration files can be created in several ways and are useful in network environments where multiple switches must be managed and monitored.

This chapter describes how configuration files are created, how they are applied to the switch, and how they can be used to enhance OmniSwitch usability.

In This Chapter

Configuration procedures described in this chapter include:

- [“Tutorial for Creating a Configuration File” on page 7-2](#)
- [“Applying Configuration Files to the Switch” on page 7-6](#)
- [“Configuration File Error Reporting” on page 7-7](#)
- [“Text Editing on the Switch” on page 7-9](#)
- [“Creating Snapshot Configuration Files” on page 7-10](#)

Configuration File Specifications

The following table lists specifications applicable to Configuration Files.

Creation Methods for Configuration Files	<ul style="list-style-type: none">• Create a text file on a word processor and upload it to the switch.• Invoke the switch's snapshot feature to create a text file.• Create a text file using one of the switch's text editors.
Timer Functions	Files can be applied immediately or by setting a timer on the switch.
Command Capture Feature	Snapshot feature captures switch configurations in a text file.
Error Reporting	Snapshot feature includes error reporting in the text file.
Text Editing on the Switch	Vi standard UNIX editor. The Ed standard UNIX editor is available in the debug mode.

Tutorial for Creating a Configuration File

This example creates a configuration file that includes CLI commands to configure the DHCP Relay application on the switch. For this example, the forward delay value is set to 15 seconds, the maximum number of hops is set to 3 and the IP address of the DHCP server is 128.251.16.52.

This tutorial shows you how to accomplish the following tasks:

- 1 Create a configuration text file containing CLI commands needed to configure DHCP Relay application.

This example used MS Notepad to create a text file on a PC workstation. The text file named **dhcp_relay.txt** contains three CLI commands needed to configure the forward delay value to 15 seconds and the maximum number of hops to 3. The IP address of the DHCP server is 128.251.16.52.

```
ip helper address 128.251.16.52
ip helper forward delay 15
ip helper maximum hops 3
```

- 2 Transfer the configuration file to the switch's file system.

To transfer the configuration file to the switch, use an FTP transfer method. For more information about transferring files onto the switch see [Chapter 1, "Managing System Files."](#)

- 3 Apply the configuration file to the switch by using the **configuration apply** command as shown here:

```
-> configuration apply dhcp_relay.txt
File configuration <dhcp_relay.txt>: completed with no errors
```

- 4 Use the **show configuration status** command to verify that the **dhcp_relay.txt** configuration file was applied to the switch. The display is similar to the one shown here:

```
-> show configuration status
File configuration <dhcp_relay.txt>: completed with no errors
File configuration: none scheduled
```

```
Running configuration and saved configuration are different
```

Note. If the configuration file applied with the **configuration apply** command results in no changes to the saved configuration, the message will state that the running configuration and saved configuration are *identical*. To synchronize the running configuration and the saved configuration, use the **write memory** command.

For more information about these displays, refer to the *OmniSwitch AOS Release 6 CLI Reference Guide*.

- 5 Use a the **show ip helper** command to verify that the DHCP Relay parameters defined in the configuration files were actually implemented on the switch. The display is similar to the one shown here:

```
-> show ip helper

Forward Delay (seconds) = 15
Max number of hops      = 3
Forwarding option       = standard
Forwarding Address:
    128.251.16.52
```

These results confirm that the commands specified in the file **dhcp_relay.txt** configuration file were successfully applied to the switch.

Quick Steps for Applying Configuration Files

Setting a File for Immediate Application

In this example, the configuration file **configfile_1** exists on the switch in the **/flash** directory. When these steps are followed, the file will be immediately applied to the switch.

- 1 Verify that there are no timer sessions pending on the switch.

```
-> show configuration status
File configuration: none scheduled
```

- 2 Apply the file by executing the **configuration apply** command, followed by the path and file name. If the configuration file is accepted with no errors, the CLI responds with a system prompt.

```
-> configuration apply /flash/configfile_1.txt
->
```

Note. Optional. You can specify *verbose mode* when applying a configuration file to the switch. When the keyword **verbose** is specified in the command line, all syntax contained in the configuration file is printed to the console. (When *verbose* is *not* specified in the command line, cursory information—number of errors and error log file name—will be printed to the console only if a syntax or configuration error is detected.)

To verify that the file was applied, enter the **show configuration status** command. The display is similar to the one shown here.

```
-> show configuration status
File configuration </flash/configfile_1.txt>: completed with 0 errors
```

For more information about this display, see “Configuration File Manager Commands” in the *OmniSwitch AOS Release 6 CLI Reference Guide*.

Setting an Application Session for a Date and Time

You can set a timed session to apply a configuration file at a specific date and time in the future. The following example applies the **bncom_cfg.txt** file at 9:00 a.m. on July 4 of the current year.

- 1 Verify that there are no current timer sessions pending on the switch.

```
-> show configuration status
File configuration: none scheduled
```

- 2 Apply the file by executing the **configuration apply** using the **at** keyword with the relevant date and time.

```
-> configuration apply bncom_cfg.txt at 09:00 04 july
```

Note. Optional. To verify that the switch received this **configuration apply** request, enter the **show configuration status** command. The display is similar to the one shown here.

```
-> show configuration status
File configuration </flash/working/bncom_cfg.txt>: scheduled at 07/04/02 09:00
```

For more information about this display see “Configuration File Manager Commands” in the *OmniSwitch AOS Release 6 CLI Reference Guide*.

Setting an Application Session for a Specified Time Period

You can set a future timed session to apply a configuration file after a specified period of time has elapsed. In the following example, the **amzncom_cfg.txt** will be applied after 6 hours and 15 minutes have elapsed.

- 1 Verify that there are no current timer sessions pending on the switch.

```
-> show configuration status
File configuration: none scheduled
```

- 2 Apply the file by executing the **configuration apply** command using the **in** keyword with the relevant time frame specified.

```
-> configuration apply amzncom_cfg.txt in 6:15
```

Note. Optional. To verify that the switch received this **configuration apply** request, enter the **show configuration status** command. The display is similar to the one shown here.

```
-> show configuration status
File configuration </flash/working/amzncom_cfg.txt>: scheduled at 03/07/02 05:02
```

The “scheduled at” date and time show when the file will be applied. This value is 6 hours and 15 minutes from the date and time the command was issued.

For more information about this display see “Configuration File Manager Commands” in the *OmniSwitch AOS Release 6 CLI Reference Guide*.

Configuration Files Overview

Instead of using CLI commands entered at a workstation, you can configure the switch using an ASCII-based text file. You may type CLI commands directly into a text document to create a *configuration file* that will reside in your switch's **/flash** directory. Configuration files are created in the following ways:

- You may create, edit, and view a file using a standard text editor (such as MS WordPad or Notepad) on a workstation. The file can then be uploaded to the switch's **/flash** file directory.
- You can invoke the switch's CLI **configuration snapshot** command to capture the switch's current configuration into a text file. This causes a configuration file to be created in the switch's **/flash** directory.
- You can use the switch's text editor to create or edit a configuration file located in the switch's **/flash** file directory.

Applying Configuration Files to the Switch

Once you have a configuration file located in the switch's file system you must load the file into running memory to make it run on the switch. You do this by using **configuration apply** command.

You may apply configuration files to the switch immediately, or you can specify a timer session. In a timer session, you schedule a file to be applied in the future at a specific date and time or after a specific period of time has passed (like a countdown). Timer sessions are very useful for certain management tasks, especially synchronized batch updates.

- For information on applying a file immediately, refer to [“Setting a File for Immediate Application” on page 7-4](#).
- For information on applying a file at a specified date and time, refer to [“Setting an Application Session for a Date and Time” on page 7-4](#).
- For information on applying a file after a specified period of time has elapsed, refer to [“Setting an Application Session for a Specified Time Period” on page 7-5](#).

Verifying a Timed Session

To verify that a timed session is running, use the **show configuration status** command. The following displays where the timed session was set using the **configuration apply qos_pol at 11:30 october 31** syntax.

```
-> show configuration status
File configuration <qos_pol>: scheduled at 01/10/31 11:30
```

Note. Only one session at a time can be scheduled on the switch. If two sessions are set, the last one will overwrite the first. Before you schedule a timed session you must use the **show configuration status** command to see if another session is already running.

The following displays where the timed session was set on March 10, 2002 at 01:00 using the **configuration apply group_config in 6:10** syntax.

```
-> show configuration status
File configuration <group_config>: scheduled at 03/10/02 07:10
```

Canceling a Timed Session

You may cancel a pending timed session by using the **configuration cancel** command. To confirm that your timer session has been canceled, use the **show configuration status** command. The following will display.

```
-> configuration cancel
-> show configuration status
File configuration: none scheduled
```

For more details about the CLI commands used to apply configuration files or to use timer sessions, refer to “Configuration File Manager Commands” in the *OmniSwitch AOS Release 6 CLI Reference Guide*.

Configuration File Error Reporting

If you apply a configuration file to the switch that contains significant errors, the application may not work. In this case, the switch will indicate the number of errors detected and print the errors into a text file that will appear in the **/flash** directory. The following display will result where the **cfg_txt** file contains three errors.

```
-> configuration apply cfg_file
Errors: 3
Log file name: cfg_txt.1.err
```

In this case, the error message indicates that the application attempt was unsuccessful. It also indicates that the switch wrote log messages into a file named **cfg_txt.1.err**, which now appears in your **/flash** directory. To view the contents of a generated error file, use the **view** command. For example, **view cfg_txt.1.err**.

Note. The keyword, **authkey**, along with a related alpha-numeric text string, are automatically included in many snapshot files (e.g., **configuration snapshot all**). The text string following the **authkey** keyword represents a login password that has been encrypted *twice*. (The first encryption occurs when a password is first created by a user; the second encryption occurs when a configuration snapshot is taken.) This dual encryption further enhances switch security. However, it is important to note that any configuration file (including a generated snapshot) that includes this dual-encrypted password information will result in an error whenever it is applied to the switch via the **configuration apply** command. This is a valid switch function and does not represent a significant problem. If an **authkey**-related error is the *only* error detected, simply remove all **authkey**-related syntax using a text editor. If a new password is required for the switch, include valid password syntax in the configuration file or immediately issue a new password using the **password** command at the command prompt.

For more information on configuration snapshots, refer to “[Creating Snapshot Configuration Files](#)” on [page 7-10](#). For more information on passwords, refer to “[User-Configured Password](#)” on [page 9-13](#).”

Note. When you enter a command using **debug set** or **debug show** keyword syntax, the switch writes the command output to a separate file that also ends with the **.err** extension. This does not mean that a configuration apply error has occurred; it is merely the switch’s standard method for displaying **debug set** or **debug show** command output.

Setting the Error File Limit

The number of files ending with the **.err** extension present in the switch's **/flash** directory is set with the **configuration error-file limit** command. You can set the switch to allow up to 25 error files in the **/flash** directory. Once the error file limit has been reached, the next error file generated will cause the error file with the oldest time stamp to be deleted. The following command sets the error file limit to 5 files:

```
-> configuration error-file limit 5
```

If you need to save files with the **.err** extension, you can either rename them so they no longer end with the **.err** extension or you may move them to another directory.

Note. The default error file limit is one file. Unless you set the error file limit to a higher number, any subsequent error file will cause any existing error file to be overwritten.

Syntax Checking

The configuration syntax check command is used to detect potential syntax errors contained in a configuration file *before* it is applied to the switch. It is recommended that you check *all* configuration files for syntax errors before applying them to your switch.

To run a syntax check on a configuration file, use the **configuration syntax check** command. For example:

```
-> configuration syntax check asc.1.snap
Errors: 3
Log file name: check asc.1.snap.1.err
```

In this example, the proposed **asc.1.snap** configuration file contains three errors. As with the **configuration apply** command, an error file (**.err**) is automatically generated by the switch whenever an error is detected. By default, this file is placed in the root **/flash** directory.

Note. The syntax, **mac alloc**, is automatically included in many snapshot files (e.g., **configuration snapshot all**). All **mac alloc**-related syntax is valid *during switch boot up only* (that is, it cannot be applied while the switch is in run-time operation). Because snapshot files are commonly used as configuration files, syntax checks may detect **mac alloc** syntax and issue an error (along with a generated **.err** file).

This is a valid switch function and does not represent a significant problem. If a **mac alloc**-related error is the *only* error detected, simply remove the syntax using a text editor, then re-check the file using the **configuration syntax check** command.

If a configuration file is located in another directory, be sure to specify the full path. For example:

```
-> configuration syntax check /flash/working/asc.1.snap
```

Viewing Generated Error File Contents

For error details, you can view the contents of a generated error file. To view the contents of an error file, use the **more** command. For example:

```
-> more asc.1.snap.1.err
```

For more information, refer to [“Displaying a Text File” on page 7-9](#).

Verbose Mode Syntax Checking

When **verbose** is specified in the command line, all syntax contained in the configuration file is printed to the console, even if no error is detected. (When **verbose** is not specified in the command line, cursory information—number of errors and error log file name—will be printed to the console only if a syntax or configuration error is detected.)

To specify verbose mode, enter the **verbose** keyword at the end of the command line. For example:

```
-> configuration syntax check asc.1.snap verbose
```

Displaying a Text File

The **more** command allows you to view a text file one screen at a time. Use this command with the desired filename. Specifying a path is optional. The following command will display the **textfile.rtf** text file located in the **/flash/working** directory.

```
-> more /flash/working/textfile.rtf
```

The switch will display the file text on your terminal screen until the entire screen is full. After that, when you press Enter, the switch will scroll the file text until it fills up another screen or until the end of the file.

The **more** mode assumes a screen that is 80 columns wide and 24 lines long.

Text Editing on the Switch

The switch software includes a standard UNIX-type line editor called “Vi”. The Vi editor is available on most UNIX systems. No attempt is being made to document Vi in this manual because information on it is freely available on the Internet.

Invoke the “Vi” Editor

You can invoke the Vi editor from the command line. Use the following syntax to view the **switchlog.txt** file located in the **/flash/working** directory:

```
-> vi /flash/working switchlog.txt
```

You can invoke the Vi editor in read-only mode by using the following syntax.

```
-> view
```

To exit the Vi editor, use the Cap ZZ key sequence.

Creating Snapshot Configuration Files

You can generate a list of configurations currently running on the switch by using the **configuration snapshot** command. A snapshot is a text file that lists commands issued to the switch during the current login session.

Note. A user must have read and write permission for the configuration family of commands to generate a snapshot file for those commands. See the “Switch Security” chapter of this manual for further information on permissions to specific command families.

Snapshot Feature List

You can specify the snapshot file so that it will capture the CLI commands for one or more switch features or for all network features. To generate a snapshot file for all network features, use the following syntax:

```
-> configuration snapshot all
```

To generate a snapshot file for specific features, select the appropriate syntax from the following list.

Snapshot Keywords

802.1Q	ipmr	rip
aaa	ip-helper	ripng
aip	interface	rdp
all	ip-routing	session
bridge	linkagg	snmp
chassis	module	stp
health	ntp	system
ip	pmm	vlan
ipms	policy	webmgt
ipv6	qos	

You may enter more than one network feature in the command line. Separate each feature with a space (and no comma). The following command will generate a snapshot file listing current configurations for the vlan, qos, and snmp command families.

```
-> configuration snapshot vlan qos snmp
```

You can verify that a new snapshot file is created by using the **ls** command to list all files in the **/flash** directory.

User-Defined Naming Options

When the snapshot syntax does not include a file name, the snapshot file is created using the default file name `asc.n.snap`. Here, the *n* character holds the place of a number indicating the order in which the snapshot file name is generated. For example, the following syntax may generate a file named **asc.1.snap**.

```
-> configuration snapshot all
```

Subsequent snapshot files without a name specified in the command syntax will become **asc.2.snap**, **asc.3.snap**, and so on.

The following command produces a snapshot file with the name **testfile.snap**.

```
-> configuration snapshot testfile.snap
```

Editing Snapshot Files

Snapshot files can be viewed, edited and reused as a configuration file. You also have the option of editing the snapshot file directly using the switch's Vi text editor or you may upload the snapshot file to a text editing software application on your workstation.

The snapshot file contains both command lines and comment lines. You can identify the comment lines because they each begin with the exclamation point (!) character. Comment lines are ignored by the switch when a snapshot file is being applied. Comment lines are located at the beginning of the snapshot file to form a sort of header. They also appear intermittently throughout the file to identify switch features or applications that apply to the commands that follow them.

Example Snapshot File Text

The following is the text of a sample snapshot file created with the **configuration snapshot all** command.

```

!=====
! File: asc.1.snap
!=====
! Chassis :
system name FujiCmm
mac alloc 91 0 1 00:d0:95:6b:09:41
! Configuration:
! VLAN :
! VLAN SL:
! IP :
ip service all
icmp unreachable net-unreachable disable
ip interface "vlan-1" address 10.255.211.70 mask 255.255.255.192 vlan 1 mtu 1500
ifindex 1
! IPMS :
! AAA :
aaa authentication default "local"
aaa authentication console "local"
! PARTM :
! 802.1x :
! QOS :
! Policy manager :
! Session manager :
! SNMP :
snmp security no security
snmp community map mode off
! IP route manager :
ip static-route 0.0.0.0 mask 0.0.0.0 gateway 10.255.211.65 metric 1
! RIP :
! IP multicast :
! IPv6 :
! RIPng :
! Health monitor :
! Interface :
! Link Aggregate :
! VLAN AGG:
! 802.1Q :
! Spanning tree :
bridge mode 1x1
! Bridging :
source-learning chassis hardware
! Bridging :
! Port mirroring :
! UDP Relay :
! Server load balance :
! System service :
! Web :
! AMAP :
! GMAP :
! Module :
! Lan Power :
! NTP :
! RDP :

```

This file shows configuration settings for the Chassis, IP, AAA, SNMP, IP route manager, Spanning tree, and Bridging services. Each of these services have configuration commands listed under their heading. All other switch services and applications are either not being using or are using default settings.

Verifying File Configuration

You can verify the content and the status of the switch's configuration files with commands listed in the following table.

show configuration status	Displays whether there is a pending timer session scheduled for a configuration file and indicates whether the running configuration and the saved configuration files are <i>identical</i> or <i>different</i> . This command also displays the number of error files that will be held in the flash directory.
show configuration snapshot	Generates a snapshot file of the switch's non-default current running configuration. A snapshot can be generated for all current network features or for one or more specific network features. A snapshot is a single text file that can be viewed, edited, and reused as a configuration file.
write terminal	Displays the switch's current running configuration for all features.

8 Managing Automatic Remote Configuration Download

The Automatic Remote Configuration feature enables:

- The automatic upgrade of firmware and/or configuration of an OmniSwitch without user intervention.
- The automated configuration of the switch on bootup, when the switch is connected to the network for the first time.
- The automatic download and installation of the critical configuration bootup and image files.

In This Chapter

This chapter describes the Automatic Remote Configuration on OmniSwitch. The sections in this chapter are:

- [“Automatic Remote Configuration Specifications” on page 8-2](#)
- [“Automatic Remote Configuration Defaults” on page 8-3](#)
- [“Quick Steps for Automatic Remote Configuration” on page 8-4](#)
- [“Overview” on page 8-5](#)
- [“Interaction With Other Features” on page 8-8](#)
- [“Automatic Remote Configuration Download Process” on page 8-9](#)
- [“Download Component Files” on page 8-12](#)
- [“LACP Auto Detection and Automatic Link Aggregate Association” on page 8-16](#)
- [“DHCP Client Auto-Configuration Process” on page 8-17](#)
- [“DHCP Server Preference” on page 8-18](#)
- [“Nearest-Edge Mode Operation” on page 8-20](#)
- [“Zero Touch License Upgrade” on page 8-22](#)
- [“Troubleshooting” on page 8-23](#)

For related information on the initial setup of the switch and switch file management, see the *OmniSwitch AOS Release 6350/6450 Hardware Users Guide*.

Automatic Remote Configuration Specifications

Platforms Supported	OmniSwitch 6350, 6450
DHCP Specifications	DHCP Server required Temporary DHCP Client on VLAN 1 or VLAN 127 (DHCP client on VLAN 127 only works on combo and uplink ports)
File Servers	TFTP FTP/SFTP
Clients supported	TFTP FTP/SFTP
Instruction file	Maximum length of: <ul style="list-style-type: none">• Pathname: 255 characters• Filename: 63 characters
Maximum length of username for FTP/SFTP file server.	15 characters
Nearest Edge MAC Address	01:20:da:02:01:73
Feature Supported only on switch bootup in Remote Configuration Load Mode (no boot.cfg file present).	LACP Auto Detection and Link Aggregate Association (operates only on combo ports and uplink ports).
Unsupported Features:	<ul style="list-style-type: none">• ISSU and IPv6 are not supported.• Upgrade of uboot, miniboot, or FPGA files is not supported.

Automatic Remote Configuration Defaults

Description	Default
Management VLAN Untagged Management VLAN	VLAN 1
DHCP broadcast VLAN 802.1q tagged VLAN	VLAN 127
Default Auto Link Aggregate Creation	Between VLAN 1 and VLAN 127
Instruction file	Location: TFTP Server File name: *.alu (* represents any instruction filename) Download location: /flash directory Downloaded as a temporary file.
Configuration file	File name: Any name Location: FTP/SFTP/TFTP Server Download location: /flash/working directory
Debug configuration file	File name: AlcatelDebug.cfg Location: FTP/SFTP/TFTP Server Download location: /flash/working directory
Script file	File name: Any name Location: FTP/SFTP/TFTP Server Download location: /flash/working directory
Firmware version	OS_*_*_R01 (*_* represents version number)
Firmware or image files	File name extension: *.img (* represents image filename) Location: FTP/SFTP/TFTP Server Download location: /flash/working directory
File download server	Primary FTP/SFTP/TFTP Server
Backup server for file download	Secondary FTP/SFTP/TFTP Server
Password for FTP/SFTP Server	Same as username

Quick Steps for Automatic Remote Configuration

- 1 Configure the DHCP server in the network to provide IP address, gateway, and TFTP server addresses to the OmniSwitch DHCP client.
- 2 Store the instruction file on the TFTP server.
- 3 Store the configuration, image, and script files on the primary and/or secondary FTP/SFTP servers.
- 4 When the OmniSwitch is integrated in to the network as a new device with no **boot.cfg** file in the *working* directory, the automatic remote configuration process is initiated.
- 5 A DHCP client is automatically configured on the OmniSwitch. The OmniSwitch obtains IP address information, TFTP server address, instruction file name, and location from the DHCP server through the DHCP client.
- 6 The OmniSwitch downloads the instruction file from the TFTP server. The instruction file contains the file names and file locations of the configuration, image, and script files.
- 7 The OmniSwitch downloads the image files from the FTP/SFTP server if necessary.
- 8 The OmniSwitch downloads the configuration file from the FTP/SFTP server, if available, and saves it as the **boot.cfg** file in the **/flash/working/** directory. If no script file is downloaded, the switch reboots applying the downloaded configuration file and the automatic configuration process is complete.
- 9 The OmniSwitch downloads the script file, if available, from the FTP/SFTP server and runs the commands in the script file.

Note.

- If the script file is not specified in the instruction file, or if it is not properly downloaded, then the Remote Configuration Manager software automatically initiates a **reload working no rollback-timeout** command after firmware or bootup configuration files are downloaded.
 - If a **write memory** command is used in the script file, then it overwrites the **boot.cfg** file. Hence, if the script file is downloaded along with the bootup configuration file, then the script file must not contain the **write memory** command.
 - If a **boot.cfg** is already present in the **working** directory of the switch, Automatic Remote Configuration Download does not occur.
-

Overview

The Automatic Remote Configuration feature provides the advantage of automatic download and installation of critical configuration and image files at initial bootup or when firmware upgrade is required for the OmniSwitch.

Automatic Remote Configuration download occurs when:

- There is no bootup configuration file (**boot.cfg**) in the *working* directory of the switch.
- During a takeover or reboot on the new Primary unit or CMM.
- The initialization process of the switch is complete and the network interfaces or ports are ready.
- There is connectivity with a DHCP server through the default VLAN 1 or through a tagged VLAN 127 from a Management Switch using the Nearest-Edge mode operation.
- There is connectivity with TFTP file server.

The following sections provide more information about the automatic configuration and download process.

Basic Operation

Automatic remote configuration process is initialized on the OmniSwitch if the **boot.cfg** file is not found in the *working* directory of the switch.

The following illustration shows the basic setup required for Automatic Remote Configuration Download operation.

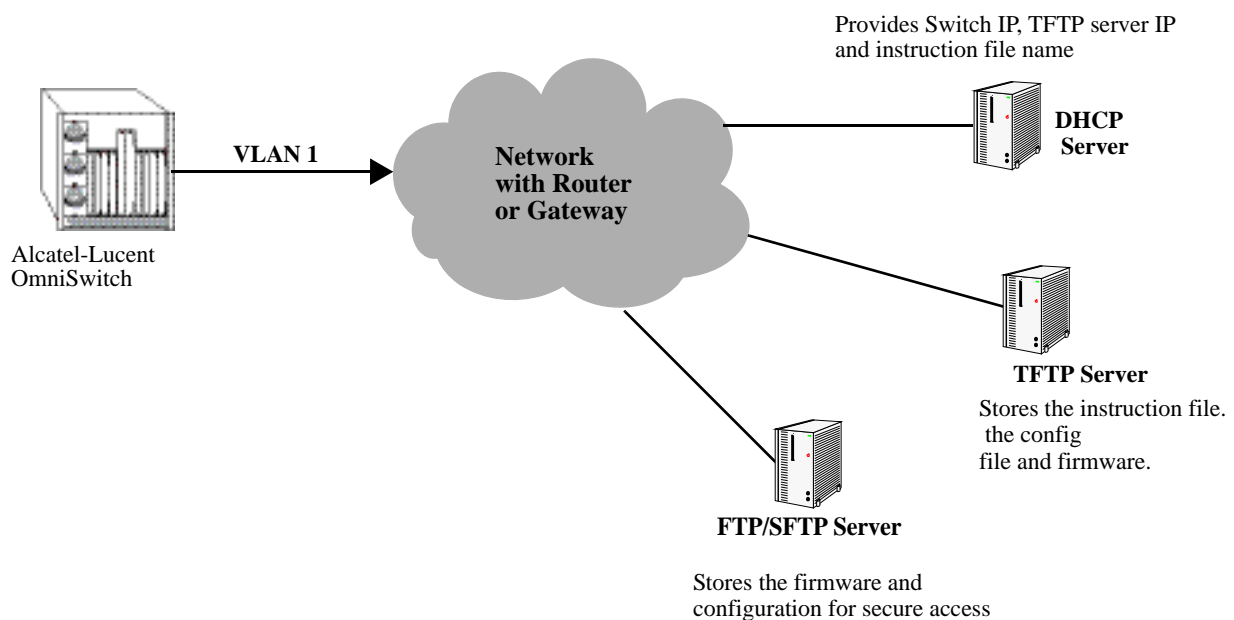

Basic Network Components for Automatic Remote Configuration Download

Network Components

The network components required for the Automatic Remote Configuration download process are:

- DHCP server (mandatory)
- TFTP file server (mandatory)
- Primary FTP/SFTP server (mandatory)
- Secondary FTP/SFTP server (optional)
- Management Switch (only required for Nearest-Edge Mode)

Information Provided by DHCP Server

When the network interfaces or ports on the switch are ready, a DHCP client is automatically configured on any available tagged or untagged VLAN. For details on the DHCP client auto-configuration, see [“DHCP Client Auto-Configuration Process” on page 8-17](#). The following information is acquired from the DHCP server, after a connection is established:

- IP address of the Network Gateway or Router.
- TFTP file server address.
- Instruction file name and location.
- Dynamic IP address for the OmniSwitch (valid only for initial bootup process).

Information Provided by Instruction File

The TFTP server address information is received from the DHCP server. The OmniSwitch downloads the instruction file from the TFTP server. The instruction file provides the following information:

- Firmware version and file location.
- Configuration file name and location.
- Debug configuration file name and location.
- Script file name and location.
- Primary FTP/SFTP file server address / type / username.
- Secondary FTP/SFTP file server address / type / username.

For more details on all the component files downloaded during the automatic remote configuration download process, see - [“Download Component Files” on page 8-12](#).

File Servers and Download Process

The download process from the file servers is as follows:

- 1 The username required to connect to the FTP/SFTP enabled servers is provided in the instruction file. The password required to connect to the servers is same as the username.
- 2 The required files mentioned in the instruction file are downloaded from the primary FTP/SFTP file server.
- 3 If the configuration, debug and script file names are specified in the instruction file, then they are downloaded to the **/flash/working** directory of the switch.
- 4 The Remote Configuration Manager now compares the current firmware version on the switch to the one mentioned in the instruction file. If the firmware version is different, then firmware upgrade is performed.
- 5 The new firmware or image files are downloaded to the *working* directory of the switch.

Note. If the primary server is down or if there is any failure in downloading the files from the primary file server, then a connection is established with the secondary file server. The secondary file server is used for file download.

- 6 All the required files are downloaded.

Note. If a specific filename (for firmware and **configuration/debug/script** files) is not found, an error is logged. The download process continues with the next available file. File transfer is tried three times and if file transfer still fails, an error is logged, and download process is stopped. In such instances, the *working* folder of the switch will contain an incomplete set of image files, configuration, debug, or script files. For details on troubleshooting under such instances, see - [“Troubleshooting” on page 8-23](#)

- 7 Now, the DHCP client configured on the related VLAN is removed.
- 8 The script file is downloaded and the commands in the script file are run. All the commands in the script file are implemented on the switch in the order specified.

For other detailed steps that are part of the automatic remote configuration download process, see [“Automatic Remote Configuration Download Process” on page 8-9](#)

LED Status

The LED status during different stages of the Automatic Remote Configuration download process is as follows:

- DHCP phase: OK LED is flashing green
- DHCP lease obtained: OK LED is solid green
- DHCP phase stopped by console login: OK LED is solid green.

Interaction With Other Features

This section contains important information about how other OmniSwitch features interact with Automatic Remote Configuration. Refer to the specific sections if required, to get detailed information about the feature interaction process.

UDP/DHCP Relay

Interaction with UDP/DHCP Relay is required for the following processes, to support Automatic Remote Configuration:

- All the DHCP responses from the DHCP server are processed. The IP address, mask, and gateway details are processed
- To acquire **Option (66) and Option(67)** information - the TFTP Server name and Boot file name are retrieved.

For details on DHCP interaction see the section [“DHCP Client Auto-Configuration Process” on page 8-17](#)

QoS

Interaction with QoS is required for the following processes, to support Auto Remote Configuration:

- Policy control lists (PCLs) are created to trap LLDP packets.
- PCLs are deleted after the required processing for Nearest-Edge Mode operation.

802.1Q

For 802.1Q tagging is applied interaction is required for Nearest Edge Mode operation

LLDP

In Nearest-Edge Mode operation LLDP packets carry and provide the advertised VLAN ID to the Access OmniSwitches running Auto Remote Configuration download.

Dynamic Link Aggregation (LACP)

Interaction with LACP is required for the following processes, to support Automatic Remote Configuration:

- To detect LACP PDU from the peer device on combo/uplink ports
- To enable the auto link aggregate creation after receiving LACP message
- The link aggregate is associated as a tagged member of VLAN 127 and VLAN 1.
- On completion of the Automatic Download and configuration process, the automatic link aggregate is disabled and all port associations are deleted.

Automatic Remote Configuration Download Process

The automatic remote configuration process is initialized when an OmniSwitch is integrated in to the network as a new device or when a firmware and configuration upgrade is required.

If the automatic configuration download process is not performed completely on the switch, manual intervention is required. For details on troubleshooting techniques under such instances, see [“Troubleshooting” on page 8-23](#)

The detailed process of Automatic Remote Configuration Download performed on the OmniSwitch is as follows:

- 1 When the switch is integrated in to the network as a new device with no **boot.cfg** file, then Automatic Remote Configuration is performed on the switch.
- 2 The Remote Configuration Manager on OmniSwitch configures a link aggregate automatically when a LACP PDU is detected on combo or uplink ports on the switch during Automatic Remote Configuration. For details, see the following section [“LACP Auto Detection and Automatic Link Aggregate Association” on page 8-16](#)
- 3 A DHCP client is automatically configured first on the default VLAN at switch boot up. OmniSwitch then uses different methods of DHCP client configuration until connection to a DHCP Server is obtained. For details, see the following section [“DHCP Client Auto-Configuration Process” on page 8-17](#)
- 4 The DHCP client looks for the OXO DHCP server response to provide preference to the desired OXO DHCP server. For details, see the following section [“DHCP Server Preference” on page 8-18](#)
- 5 The DHCP client obtains the switch IP address information from the DHCP server.
- 6 The DHCP client obtains the TFTP server IP address from the DHCP server using Option (66).
- 7 The DHCP client obtains the instruction file name and location from the DHCP server using Option (67).
- 8 SSH access is automatically enabled to allow remote access in case the automatic configuration process fails.
- 9 The instruction file with the **.alu** extension is downloaded from the TFTP server to the **/flash/working** directory of the OmniSwitch.
- 10 If available, the configuration, script, and images files are downloaded from the FTP or SFTP servers. The password used to connect to the FTP/SFTP servers is same as the username.
- 11 If available, the switch compares the firmware version available on the switch with the firmware version in the instruction file. If the firmware versions are different, then the new firmware is downloaded in to the **/flash/working** directory.
- 12 If available, the downloaded configuration file is saved as the **boot.cfg** file in the **/flash/working** directory and the switch is rebooted completing the auto configuration process (a reboot occurs only if no script file is downloaded).
- 13 If available, commands in the script file are run and the DHCP client configuration is automatically removed on the default VLAN 1.

Process Illustration

The following flowchart represents the automatic remote configuration download process in detail.

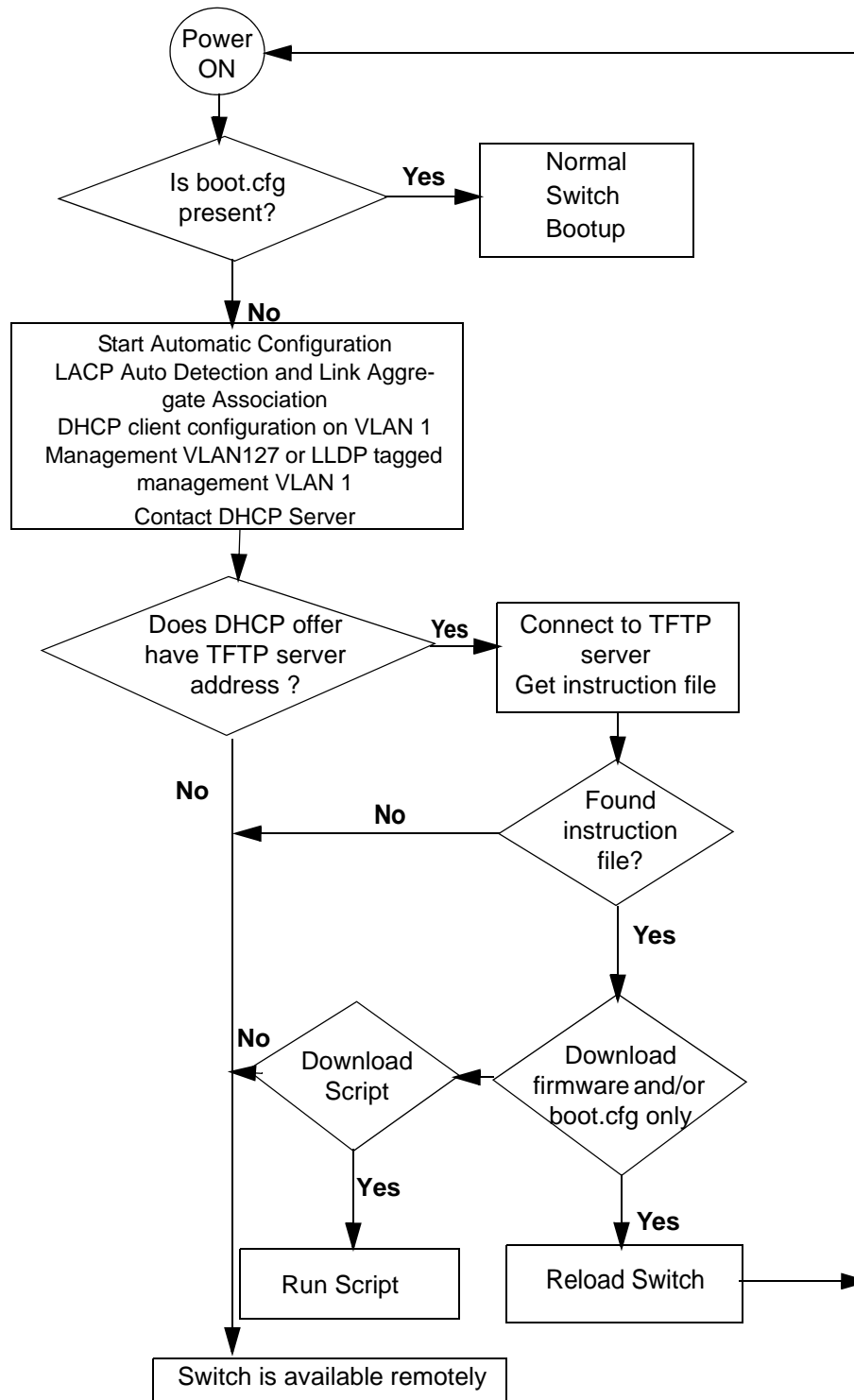

Illustration of Automatic Remote Configuration Process

Additional Process Notes

1 Once the switch obtains an IP interface from the DHCP server, remote access through SSH is automatically configured to allow remote access in case of any download errors during the Auto Configuration process.

Note. It is not recommended to have the **write memory** command in the script file if a configuration file is downloaded. This causes the **boot.cfg** file to be overwritten with the commands in the script file.

2 After the successful download of the script file, the DHCP IP interface is automatically deleted. However, SSH access remains enabled. Use the **no aaa authentication ssh** command to disable SSH connectivity if desired.

Download Component Files

This section provides the details of the files downloaded and how they are utilized during the automatic configuration process. The main component files are:

- **Instruction file** - The instruction file is the initial file required for the automatic remote configuration process to occur. The instruction file is stored in the TFTP server with the **.alu** extension. For further details, see [“Instruction File” on page 8-12](#)
- **Firmware upgrade files** - The firmware files or image files differ for different OmniSwitch platforms. These image files contain executable code, which provides support for the system, Ethernet ports, and network functions. For further details, see [“Firmware Upgrade Files” on page 8-14](#)
- **Bootup configuration file** - The file contains bootup configuration information for the switch. The bootup configuration file stores the network configuration parameters. For further details, see [“Bootup Configuration File” on page 8-14](#)
- **Debug Configuration file** - The debug configuration file stores the default debug configuration information. For further details, see [“Debug Configuration File” on page 8-15](#)
- **Script file** - The script file consists of commands to be performed on the switch so that appropriate actions can be taken on the downloaded files. For further details, see [“Script File” on page 8-15](#)

Instruction File

The instruction file is the initial file required for automatic remote configuration process to occur. The instruction file is stored in the TFTP server with the **.alu** extension.

The instruction file contains user information such as switch ID, file version, firmware version, image file names and location, configuration file (**boot.cfg**) name and location, script file name and location, FTP/SFTP server IP address, username and password to connect to the FTP/SFTP server.

The TFTP server IP address and instruction filename details are received from the DHCP server by the DHCP client on the OmniSwitch.

The instruction file is downloaded from the TFTP server and stored in the **/flash/working** directory of the switch.

Note.

- If an error or failure occurs during the file transfer, the transfer process is retried up to three times. If file transfer and download are not successful, the automatic remote configuration process is halted and the switch is made available remotely using SSH.
 - All contents of the instruction file are stored in the switch log (**swlog.log**) file as evidence of the last Automatic Remote Configuration download.
-

Instruction File Syntax

The instruction file is a text file containing the following information:

Header	Contains user information such as switch ID, file version, and so on. Header text is a type of comment.
Comments	Comments provide additional information for better user readability. These lines are ignored during the remote configuration download process.
Firmware version and file location	Image files required for firmware upgrade.
Configuration file name and location	The file containing the configuration for the switch, this file is saved as the boot.cfg file in the /flash/working directory.
Debug file name and location	The AlcatelDebug.cfg containing additional debug configuration commands
Script file name and location	The script file containing commands to be implemented on the switch.
Primary file server address/protocol/username	The primary file server from which the required files are downloaded. The specified protocol and username is used for the download.
Secondary file server address/protocol/username	The secondary file server from which the required files are downloaded if the connection to primary file server fails. The specified protocol and username are used for the download.

Example

The instruction file has the Keyword:Value format as shown below:

```
Firmware version:OS_6_7_2_12_R01
Firmware location:/home/ftpboot
! Configuration file
!Config filename:vcboot.cfg
Config filename:boot.cfg
!Config filename:None
Config location:/home/ftpboot
! Setup File
!VC setup config filename:vcsetup.cfg
!VC setup config location:/home/ftpboot
! Script file
!Script filename:default_script.txt
!Script location:/home/ftpboot
! License filename
!License filename:swlicense.dat
!License location:/home/ftpboot/license
! Directory name
!Directory name:working
Directory name:working
!Directory name:certified
! Primary File Server
Primary server:120.1.1.1
Primary protocol:FTP
Primary user:admin
! Secondary File Server
!Secondary server:15.1.1.2
!Secondary protocol:FTP
!Secondary user:admin
```

Instruction File Usage Guidelines

- The instruction file is case sensitive and can contain only the keywords provided in the instruction file output example.
- The keywords can be placed in any order.
- If the Keyword:Value format is incorrect, the information on that line is discarded.
- Firmware version must be provided in the format as specified in the example.
- Pathnames provided must contain the complete path to the file location.
- If any file is not required, the value is provided as “None”. For example, if a debug configuration file is not required to be downloaded, the instruction file syntax is as follows:

```
Debug filename:None
Debug location:None
```
- The header line is the first line of the instruction file and begins with “!” character.
- Header line contents are logged to the switch log along with the other contents of the instruction file.
- The header and comment lines begin with “!” character.

Firmware Upgrade Files

Firmware files are also known as image files. These files have the **.img** extension.

Firmware files are different for each OmniSwitch platform. The relevant firmware files are downloaded from the location mentioned in the instruction file. The filenames of the firmware files must exactly match the files which are to be downloaded. The filenames are in the ***os.img**, ***base.img**, ***en.img** format, where * can be ‘J’, ‘K’, ‘K2’, ‘K2I’, or ‘G’ based on the OmniSwitch product. Modified filenames are not recognized.

Details about the different firmware files and file names can be found in the *Available Image Files* section in [“Managing System Files” on page 1-1](#).

Firmware files are downloaded only when the firmware version in the instruction file is higher than the firmware version present on the switch.

Bootup Configuration File

The bootup configuration (**boot.cfg**) file is not present during the initial bootup process when a new switch is integrated in to the network. The **boot.cfg** file is automatically generated and stored in the **/flash/working** directory when a **write memory** command is issued.

During the automatic remote configuration process, the bootup configuration file is downloaded from the FTP/SFTP server and stored as **boot.cfg** in the **/flash/working** directory of the switch.

If no script file is downloaded, the switch boots up normally according to the configurations specified in the **boot.cfg** file when the remote configuration download process is completed.

Bootup Configuration File Usage Guidelines

If configuring an AAA server authentication key in the **boot.cfg** file the encrypted value of the key must be stored in the **boot.cfg** file. To get the encrypted value first enter the key using the CLI and then use the

show configuration snapshot command to get the encrypted value. This encrypted value can then be used in the **boot.cfg** file for Remote Configuration Download.

Debug Configuration File

The debug configuration file is used for setting specific OmniSwitch settings and must only be used as directed by Service and Support. During the automatic remote configuration process, the debug configuration file is downloaded with the filename **AlcatelDebug.cfg**.

Script File

The script file is downloaded and stored with the same name in the **/flash/working** directory. The script file contains the commands to be implemented on the switch after running the configuration file.

If a configuration file is not available, the script file can be used to configure the switch dynamically without a **boot.cfg** file.

Script File Example

```
vlan 100 enable name "VLAN 100"  
vlan 100 port default 1/1  
write memory
```

Script File Usage Guidelines

- After the script file is downloaded the switch does not automatically reboot.
- If a **write memory** command is used in the script file, then it overwrites the **boot.cfg** file. Hence, the script file must not contain the **write memory** command if it is downloaded along with the configuration file.
- If any script file command fails, it is logged in to a file ***.err** (* is the script file name) in the **/flash** directory and the remaining commands are implemented.
- If the script file name mentioned in the instruction file is incorrect, then an error is logged in the switch log or **swlog.log** file.

LACP Auto Detection and Automatic Link Aggregate Association

DHCP Server Association and DHCP Client creation works on fixed ports. When an OmniSwitch is newly introduced to a network, an assigned peer network device detects this device as new. If the peer device has a link aggregate configuration on the detecting port, then it sends LACP PDU to the newly connected OmniSwitch. In such instances, LACP PDUs must be acknowledged by OmniSwitch. The Remote Configuration Manager on OmniSwitch detects any LACP PDUs on combo or uplink ports and configures a link aggregate automatically during Automatic Remote Configuration.

The following diagram illustrates the different network components required for Auto Remote Configuration and LACP Auto Detection and Link Aggregate Association process

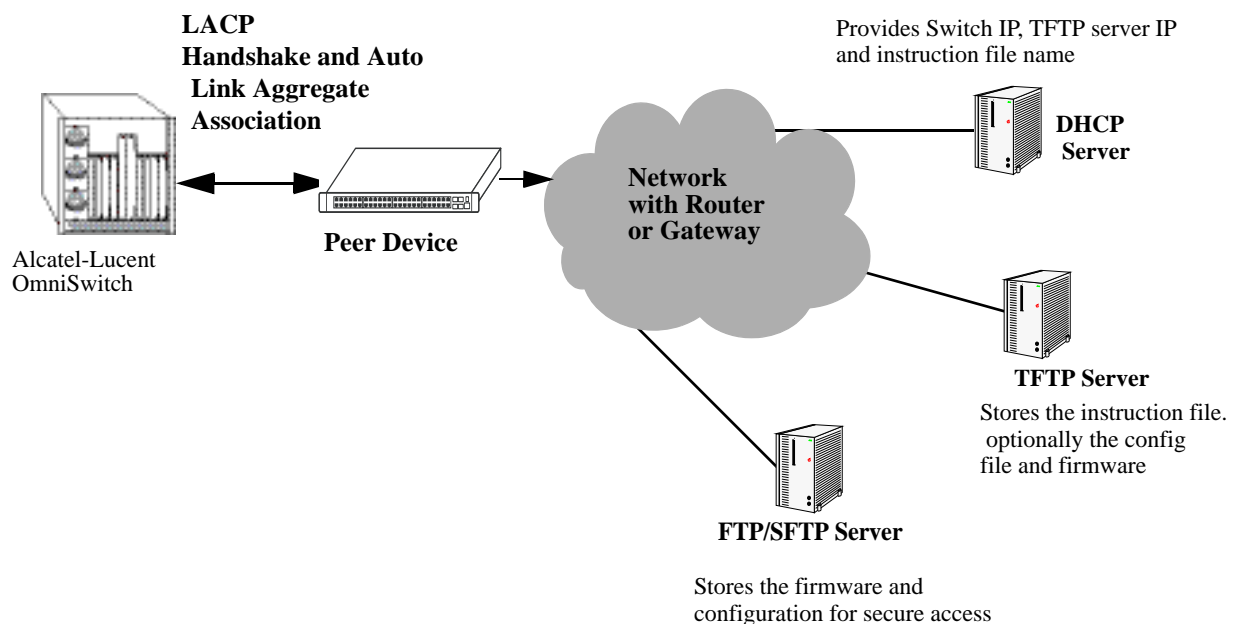

Network Components for LACP Auto Detection and Link Aggregate Association

LACP auto detection is enabled by default and operates only on the combo ports and uplink ports on OmniSwitch during the Automatic Remote Configuration stage.

- 1 When an OmniSwitch detects LACP PDUs from a remote peer connected through a combo or an uplink port, it configures that port as a LACP port and starts LACP handshake with the peer device.
- 2 The newly formed LACP port is made a member of VLAN 127 and VLAN 1 and DHCP packets are sent out through this LACP port.
- 3 Once the remote configuration download is complete on this LACP port, the switch configuration file can automatically configure the required ports for the link aggregate.
- 4 After the process is completed, this automatic link aggregate and related associations are deleted.

Note. The LACP auto detection mode is not supported when the switch boots up in normal mode (non-remote configuration load mode). The LACP configuration at the peer device must not be changed once the automatic link aggregate is created using the parameters in the LACP PDU sent from the peer device.

DHCP Client Auto-Configuration Process

The automatic remote configuration download feature supports three DHCP client configuration methods to obtain an initial dynamic IP address from the DHCP server:

- Static DHCP client on untagged VLAN 1
- Dynamic DHCP client on tagged VLAN 127
- Dynamic DHCP client on LLDP tagged management VLAN

Note. Some Metro networks use a fixed tagged VLAN 127 for initial IP assignment. The auto-configuration of Dynamic DHCP client on LLDP tagged management VLAN facilitates the installation of OmniSwitch in such networks.

OmniSwitch creates a DHCP Client interface on:

- the default untagged VLAN 1 and then on tagged VLAN 127 alternatively

Or

- the Management VLAN being advertised in the LLDP PDUs sent by the Management Switch configured in Nearest-Edge Mode.

See the [“Nearest-Edge Mode Operation” on page 8-20](#) for additional information.

Note. OmniSwitch must have at least one port with connectivity to the DHCP server through Management VLAN.

If OmniSwitch receives LLDP PDUs with VLAN and port information from a Management switch in nearest edge mode, then the DHCP client interface is moved to user defined LLDP management VLAN on the network.

The detailed process of DHCP client auto-configuration on OmniSwitch is as follows:

- 1 At boot-up, the initial DHCP client starts with untagged VLAN 1. The DHCP client waits for 30 seconds for a DHCP lease.
- 2 If the lease is not obtained even after 30 seconds, the DHCP client is stopped on the untagged VLAN 1 and DHCP client is started on tagged VLAN 127. The DHCP client on tagged VLAN 127 waits for 30 seconds for a DHCP lease.
- 3 If the DHCP client does not get the lease in 30 seconds, DHCP client moves back to untagged VLAN 1 and this process continues until it gets the DHCP lease on any one of the two VLANs.
- 4 If a LLDP that is advertising the management VLAN ID is received on any of the switch ports, the initial DHCP client on untagged VLAN and tagged VLAN 127 is stopped and a new DHCP client is started on this tagged management VLAN.
- 5 The DHCP Client created on tagged management VLAN waits infinitely to get a lease.

Note.

If the initial DHCP clients (untagged or VLAN 127) obtains an IP lease, the LLDP detection mechanism is disabled to prevent the switch from starting a new DHCP client.

DHCP client is automatically stopped once a user logs in the switch through console port before getting the DHCP lease. This condition applies for any type of DHCP client (untagged, tagged 127 or tagged with LLDP associated management VLAN).

Once the DHCP client gets the lease, the Remote Config process does not stop even if the user logs on to the switch through console port.

DHCP Server Preference

When RCL is running and the DHCP client is created, the following steps are followed in order to provide preference to different DHCP servers. The preference for the VLAN 1 DHCP client is below:

- 1 OmniVista Server = VSI: alcatel.nms.ov2500
- 2 OXO DHCP Server = VSI: alcatel.a4400.0
- 3 Other non-preferred DHCP Server

The following describes the DHCP client preference operation:

- 1 If a DHCP response is received on the VLAN 1 DHCP client from a non-preferred DHCP server it will be stored during the 30 second window allowing time for a DHCP response from a higher preference server. Subsequent responses from non-preferred DHCP servers will be dropped.
- 2 If a DHCP response is received on the VLAN 1 DHCP client from an OXO DHCP server it will overwrite any non-preferred DHCP response. The response will be stored during the 30 second window allow-

ing time for a DHCP response from an OmniVista server. Subsequent responses from any OXO DHCP servers or non-preferred DHCP servers will be dropped.

3 If a DHCP response is received on the VLAN 1 DHCP client from an OmniVista DHCP server it will overwrite any existing DHCP responses and be applied immediately.

4 If a DHCP response is received on the VLAN 127 DHCP client it will be applied immediately regardless of which DHCP server it was received from. Receiving a DHCP response on VLAN 127 indicates there was no response received on VLAN 1 from any preferred DHCP server.

5 If any VLAN ID is received from LLDP during the DHCP process and no response has been received from an OmniVista or OXO server, then the DHCP client on VLAN 1 or on VLAN 127 is deleted and a DHCP client gets created on management VLAN received from LLDP.

Note:

- A DHCP server should be configured and have connectivity the switch during the initial boot-up.
 - The RCL process may be delayed while waiting for a preferred server.
-

Nearest-Edge Mode Operation

In order for the network to propagate Nearest-Edge mode LLDP PDUs a Management Switch must be configured to send the LLDP PDUs with the Management VLAN information. Additionally, the peer switches are automatically configured to process the Nearest-Edge Mode LLDP PDU frames by the Automatic Configuration Download feature.

An OmniSwitch running the Automatic Remote Configuration feature is automatically enabled to process LLDP PDUs with the unique Nearest-Edge destination MAC address. In Nearest-Edge mode the Management OmniSwitch uses a unique MAC address when sending LLDP PDUs. The network OmniSwitch also looks for these unique packets to determine a Management VLAN. It then creates a DHCP client interface on that tagged VLAN.

LLDP Transmission from Management Switch

- The Management Switch is configured to use the Nearest-Edge Mode MAC address using the **lldp destination mac-address** command and is connected to the network using an untagged interface.
- LLDP is configured on the untagged port of the Management Switch so that the LLDP PDUs are sent with the Management VLAN information.
- The LLDP interval must not be set higher than 30 seconds (default).
- The Management Switch sends LLDP PDUs on the untagged interface with the MAC address of 01:20:DA:02:01:73.

LLDP Propagation through Network

These LLDP PDUs are propagated throughout the network as normal L2 multicast frames, eventually reaching the Access Switch.

LLDP Reception by Access Switch

The Automatic Configuration Download feature enables the processing of the Nearest-edge LLDP PDUs by default.

Nearest-Edge Mode Configuration Example

Management Switch

The Management Switch is connected to the network using an untagged interface and is configured to use the Nearest-edge Mode MAC address using the **lldp destination mac-address** command. LLDP is configured on the untagged port of the Management Switch so that the LLDP PDUs are sent with the Management VLAN information. The LLDP PDUs are sent on the untagged interface with the Nearest-edge MAC address and propagated throughout the network eventually reaching the Access Switch.

For example:

```
-> vlan 999 name "VLAN 999"
-> vlan 999 port default 1/1
-> lldp destination mac-address nearest-edge
-> lldp 1/1 tlv dot1 vlan-name enable
```

Access Switch

When used in conjunction with the Automatic Remote Configuration feature no configuration is necessary on the Access OmniSwitches. Newly connected switches without a *boot.cfg* file receive the Nearest-Edge LLDP PDUs, discover the Management VLAN, tag the port with that VLAN ID, and create a DHCP client interface on the Management VLAN. This auto-configuration allows the DHCP client interface on the OmniSwitch to receive an IP address in the proper IP subnet.

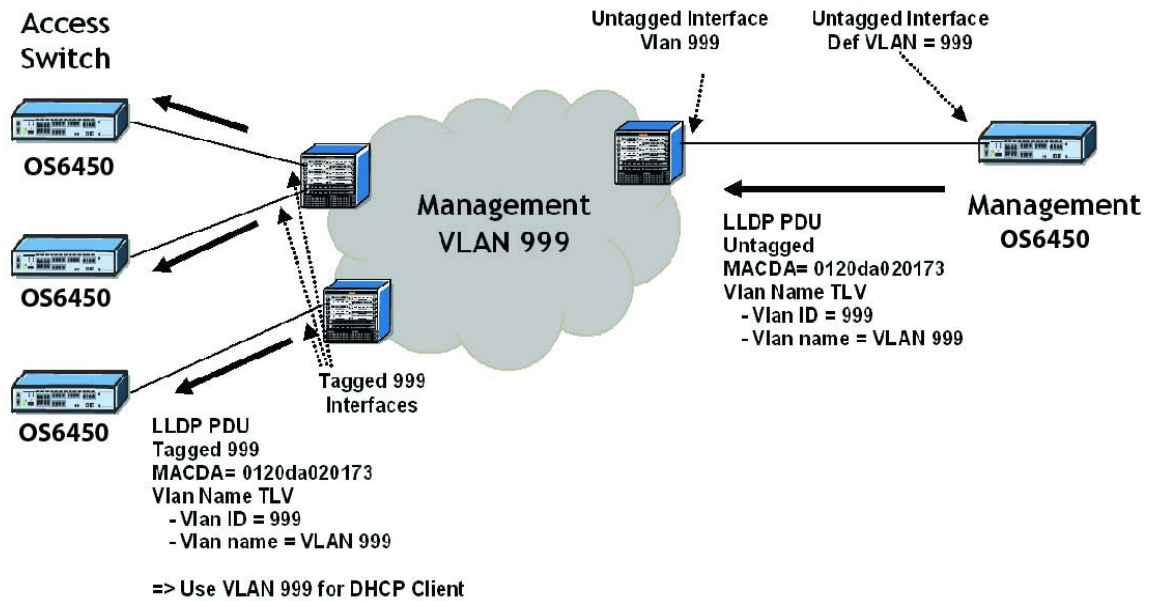

Example Nearest-Edge Configuration

Zero Touch License Upgrade

Some features like OmniSwitch-Metro features require a software license for activation and are restricted only to a licensed user. To activate licensed features, a license serial number must be purchased along with an authorization code from Alcatel-Lucent. The authorization code can then be used to generate a license file.

The Automatic Remote Configuration Download feature supports automatic license upgrade process for remote devices. With Zero Touch License Upgrade, the metro features can be unlocked on each non-metro switch in a network. The switches are automatically upgraded with the set license for a trial period. This feature can be implemented by running a script file with the **license unlock metro** command.

Note. This upgrade procedure does not affect OmniSwitch Metro models as they already have the metro features activated.

The metro features are activated on the switch for a trial period of 15 days. In order to get a permanent license, the customer must identify the MAC address or serial number of the newly installed switches in the network and obtain the license file from the Alcatel-Lucent portal and install it.

Note. For detailed procedure on manual license upgrade see the [Installing Software Licenses](#) section in the “[Managing System Files](#)” chapter. Also see the different types of license upgrades available.

The reboot of the switch or stack occurs at the end of automatic remote configuration process.

If any of the switches in the network already have the metro license installed, then the automatic license upgrade does not occur. Specifically, the switch or stack does not reboot again.

Script File Example

For Zero Touch License Upgrade to occur, the script file must contain the **license unlock metro** command. For details on the command see the *OmniSwitch AOS Release 6 CLI Reference Guide*.

```
->vlan 100 enable name "VLAN 100"  
->vlan 100 port default 1/1  
->license unlock metro  
->write memory  
->reload working no rollback-timeout
```

Troubleshooting

Due to errors during download, the automatic configuration process can halt, or the file download process can be incomplete. The errors that occur during the automatic remote configuration download process are displayed on the switch command prompt and also stored in switch log or the **swlog.log** file.

The following section provides information on some of the common errors that can occur during the configuration download process and troubleshooting techniques to resolve these errors.

Error Resolution

If there are any issues downloading the required files for the auto configuration process the switch can be reached using the DHCP client IP address and the SSH protocol for manual intervention or configuration.

Server Connection Failure and File Download Errors

Manual download of component files is required when there is a failure in connecting to the servers or when all the component files are not downloaded during the automatic remote configuration download process.

Server connection failures can occur when:

- DHCP server is not reachable.
- TFTP server is not reachable.
- Primary and secondary servers are not reachable.

File download errors can occur when:

- Files are corrupted.
- File locations or names listed in the instruction file are incorrect.

Error Description Table

The following table provides information on the common server connection failures and file download errors that can occur during Automatic Remote Configuration:

Error Type	Error	Description
User Login Auto-Config Abort	User logged in via console, Automatic Remote configuration is aborted.	DHCP client is automatically stopped only if a user logs in to the switch through console port before getting the DHCP lease.
TFTP Response Timeout	Instruction File not Downloaded and the Max try 3 For TFTP reached.	Instruction file not downloaded due to TFTP not reachable.
Primary/Secondary Server Connection	Download of file: <File name and pathname> from Primary Server Failed	File download failure from primary server.
	Starting download of file: <File name and pathname> from Secondary Server	
	Download Failed - <File name and pathname> using both Pri & Sec IP	File download failure from both primary and secondary server.
File Download and File Location Errors	Transfer error <File name and pathname>	File transfer failure.
	Download failed for configuration file <File name and pathname>	Configuration file download failure.
	Not all image files are downloaded	Some of the image files are not downloaded.
	Unable to download the firmware version	File location errors occur when the corresponding files are not available in the locations as mentioned in the instruction file.
	Unable to download boot config file	
	Unable to download AlcatelDebug.cfg	
	Unable to download script file	

Script File Errors

The different types of script file errors and the troubleshooting techniques for such errors are as follows:

- If any script file command fails, it is logged in to a file ***.err** (* is the script file name) in the **/flash** directory and the remaining commands are implemented. In such an instance, check the ***.err** file. The script file commands can be manually implemented and debugged in the order specified in the script file.
- If the script file name mentioned in the instruction file is incorrect, then an error is logged in the switch log or **swlog.log** file. In such an instance, check the **swlog.log** file. The script file can be downloaded manually from the FTP/SFTP servers and implemented onto the OmniSwitch.

Error Description Table

The following error description table provides information about some of the common script file errors that occur during Automatic Remote Configuration:

Error Type	Error	Description
Script File Download	Download of Script file from Primary Server Failed	Script file cannot be downloaded from the primary server.
	Starting download of Script file: <File name and pathname> from Secondary Server Download failed - <File name and pathname> using Pri and Sec IP	Script file cannot be downloaded from both primary and secondary server.
Script File Command Failure	Unable to remove Instruction file <File name and pathname>	Instruction file cannot be removed from flash due to error in running the script file commands.
	Error in executing the downloaded script file	The downloaded script file cannot be run.

9 Managing Switch User Accounts

Switch user accounts can be set up locally on the switch for users to log into and manage the switch. The accounts specify login information (combinations of usernames and passwords) and privilege or profile information depending on the type of user.

The switch has several interfaces (console, Telnet, HTTP, FTP, Secure Shell, and SNMP) through which users can access the switch. The switch can be set up to allow or deny access through any of these interfaces. See [Chapter 10, “Managing Switch Security,”](#) for information about setting up management interfaces.

In This Chapter

This chapter describes how to set up user accounts locally on the switch through the Command Line Interface (CLI). CLI commands are used in the configuration examples; for more details about the syntax of commands, see the *OmniSwitch AOS Release 6 CLI Reference Guide*.

This chapter provides an overview of user accounts. In addition, configuration procedures described in this chapter include:

- [“Creating a User” on page 9-12.](#)
- [“Configuring Password Policy Settings” on page 9-14.](#)
- [“Configuring Privileges for a User” on page 9-21.](#)
- [“Setting Up SNMP Access for a User Account” on page 9-22.](#)
- [“Setting Up End-User Profiles” on page 9-25.](#)

For information about enabling management interfaces on the switch, see [Chapter 10, “Managing Switch Security.”](#)

For information about connecting a management station to the switch, see *OmniSwitch AOS Release 6350/6450 Hardware Users Guide*.

User information can also be configured on external servers in addition to, or instead of, user accounts configured locally on the switch (except end-user profiles, which can only be configured on the switch). For information about setting up external servers that are configured with user information, see the “Managing Authentication Servers” chapter in the *OmniSwitch AOS Release 6 Network Configuration Guide*.

User Database Specifications

Platforms Supported	OmniSwitch 6350, 6450
Maximum number of alphanumeric characters in a username	31
Maximum number of alphanumeric characters in a user password	31
Maximum number of alphanumeric characters in an end-user profile name	32
Maximum number of user accounts	64
Maximum number of end-user profiles	128

User Account Defaults

- Two user accounts are available on the switch by default: **admin** and **default**. For more information about these accounts, see [“Startup Defaults” on page 9-6](#) and [“Default User Settings” on page 9-9](#).
- New users inherit the privileges of the **default** user if the specific privileges for the user are not configured; the default user is modifiable.
- Password defaults are as follows:

Description	Command	Default
Minimum password length	user password-size min	8 characters
Default password expiration for any user	user password-expiration	disabled
Username is not allowed in password.	user password-policy cannot-contain-username	disabled
Minimum number of uppercase characters allowed in a password.	user password-policy min-upper-case	0 (disabled)
Minimum number of lowercase characters allowed in a password.	user password-policy min-lower-case	0 (disabled)
Minimum number of base-10 digits allowed in a password.	user password-policy min-digit	0 (disabled)
Minimum number of non-alphanumeric characters allowed in a password.	user password-policy min-nonalpha	0 (disabled)
Maximum number of old passwords to retain in the password history.	user password-history	4
Minimum number of days user is blocked from changing password.	user password-min-age	0 (disabled)

- Global user account lockout defaults are as follows:

Parameter Description	Command	Default
Length of time during which failed login attempts are counted.	user lockout-window	0—all attempts are counted
Length of time a user account remains locked out of the switch before the account is automatically unlocked.	user lockout-duration	0—account remains locked until manually unlocked
Maximum number of failed login attempts allowed during the lockout window time period.	user lockout-threshold	0—no limit to the number of failed login attempts

Overview of User Accounts

A user account includes a login name, password, and user privileges. The account also includes privilege or profile information, depending on the type of user account. There are two types of accounts: network administrator accounts and end-user or customer login accounts.

Network administrator accounts are configured with user (sometimes called *functional*) privileges. These privileges determine whether the user has read or write access to the switch and which command **domains** and command **families** the user is authorized to execute on the switch.

Customer login accounts are configured with end-user profiles rather than functional privileges. Profiles are configured separately and then attached to the user account. A profile specifies command **areas** to which a user has access as well as VLAN and/or port ranges to which the user has access.

The designation of particular command families/domains or command families for user access is sometimes referred to as *partitioned management*. The privileges and profiles are sometimes referred to as *authorization*.

Note. End-user command areas are different from the command domains/families used for network administrator accounts. In general, command areas are much more restricted groups of commands (see [page 9-25](#)).

Functional privileges (network administration) and end-user profiles (customer login) are mutually exclusive. Both types of users can exist on the switch, but any given user account can only be one type, network administrator or customer login. The CLI in the switch prevents you from configuring both privileges and a profile for the same user.

End-user profiles also cannot be configured on an authentication server; however, users configured on an external authentication server can have profile attributes, which the switch will attempt to match to profiles configured locally.

If the user information is configured on an external server (rather than locally on the switch through the CLI) with both functional privilege attributes *and* profile attributes, the user is seen by the switch as an end-user and will attempt to match the profile name to a profile name configured on the switch. If there is no match, the user will not be able to log into the switch.

Note. For information about setting up user information on an authentication (AAA) server, see the “Managing Authentication Servers” chapter of the *OmniSwitch AOS Release 6 Network Configuration Guide*.

Users typically log into the switch through one of the following methods:

- **Console port**—A direct connection to the switch through the console port.
- **Telnet**—Any standard Telnet client can be used for logging into the switch.
- **FTP**—Any standard FTP client can be used for logging into the switch.
- **HTTP**—The switch has a Web browser management interface for users logging in via HTTP. This management tool is called WebView.

- **Secure Shell**—Any standard Secure Shell client can be used for logging into the switch.
- **SNMP**—Any standard SNMP browser can be used for logging into the switch.

For more information about connecting to the switch through one of these methods, see *OmniSwitch AOS Release 6350/6450 Hardware Users Guide*.

For information about setting up the switch to allow user access through these interfaces, see [Chapter 10, “Managing Switch Security.”](#)

Startup Defaults

By default, a single user management account is available at the first bootup of the switch. This account has the following user name and password:

- user name—**admin**
- password—**switch**

Initially, the **admin** user can only be authorized on the switch through the console port. Management access through any other interface is disabled. The Authenticated Switch Access commands can be used to enable access through other interfaces or services (such as Telnet, HTTP). However, SNMP access is not allowed for the admin user. Also, the admin user cannot be modified, except for the password.

Password expiration for the admin user is disabled by default. See [“Configuring Password Expiration” on page 9-16](#).

In addition, another account, **default**, is available on the switch for default settings only; this account cannot be used to log into the switch. It is used to store and modify default settings for new users.

Note. Up to 64 users can be configured in the local switch database.

To set up a user account, use the **user** command, which specifies the following:

- *Password*—The password is required for new users or when modifying a user’s SNMP access. The password will not appear in an ASCII configuration file created via the **snapshot** command.
- *Privileges*—The user’s read and write access to command domains and families. See [“Configuring Privileges for a User” on page 9-21](#) for more details.
- *SNMP access*—Whether or not the user is permitted to manage the switch via SNMP. See [“Setting Up SNMP Access for a User Account” on page 9-22](#) for more details.
- *End-User Profile*—The user’s read and write access to command areas, port ranges, and VLAN ranges; used for customer login accounts. See [“Setting Up End-User Profiles” on page 9-25](#).

Typically, options for the user (privileges or end-user profile; SNMP access) are configured at the same time the user is created. An example of creating a user and setting access privileges for the account is given here:

```
-> user thomas techpubs read-write domain-policy md5+des
```

For more details about command syntax, see the *OmniSwitch AOS Release 6 CLI Reference Guide*.

Quick Steps for Network Administrator User Accounts

1 Configure the user with the relevant username and password. For example, to create a user called **thomas** with a password of **techpubs**, enter the following:

```
-> user thomas password techpubs
```

For information about creating a user and setting up a password, see [“Creating a User” on page 9-12](#).

2 Configure the user privileges (and SNMP access) if the user must have privileges that are different than those set up for the **default** user account. For example:

```
-> user thomas read-write domain-network ip-helper telnet
```

For information about the default user settings, see the next section. For information about setting up privileges, see [“Configuring Privileges for a User” on page 9-21](#).

Note. *Optional.* To verify the user account, enter the **show user** command. The display is similar to the following:

```
User name = admin,
Password expiration      = None,
Password allow to be modified date      = None,
Account lockout         = None,
Password bad attempts   = 1,
Read Only for domains   = None,
Read/Write for domains  = All ,
Snmp allowed            = NO
```

```
User name = default (*),
Password expiration     = None,
Password allow to be modified date     = None,
Account lockout        = None,
Password bad attempts   = 0,
Read Only for domains   = None,
Read/Write for domains  = None,
Snmp allowed           = NO,
```

```
User name = public (*),
Password expiration     = None,
Password allow to be modified date     = None,
Account lockout        = None,
Password bad attempts   = 0,
Read Only for domains   = None,
Read/Write for domains  = None,
Snmp allowed           = NO,
```

(*)Note:

The default user is not an active user account.
It contains the default user account settings,
for new user accounts.

For more information about the **show user** command, see the *OmniSwitch AOS Release 6 CLI Reference Guide*.

Quick Steps for Creating Customer Login User Accounts

- 1 Set up a user profile through the [aaa admin-logout](#) command. For example, configure a profile called **Profile1** that specifies read-write access to the **physical** and **basic-ip-routing** command areas:

```
-> end-user profile Profile1 read-write physical basic-ip-routing
```

- 2 Specify ports to which the profile will allow access. In this example, **Profile1** will be configured with access to ports on slot 1 and slot 2.

```
-> end-user profile Profile1 port-list 1/1-2 1/4-5 2/1-8
```

- 3 Specify VLANs or VLAN ranges to which the profile will allow access. In this example, **Profile1** will be configured with access to VLANs 3 through 8.

```
-> end-user profile Profile1 vlan-range 3-8
```

Note. *Optional.* To verify the end-user profile, enter the [show end-user profile](#) command. The display is similar to the following:

```
End user profile : Profile1
  Area accessible with read and write rights :
    physical,
    basic ip routing,
  Slot : 1, ports allowed : 1-2, 4-5
  Slot : 2, ports allowed : 1-8
  Vlan Id :
  3-8
```

For more information about the [show end-user profile](#) command, see the *OmniSwitch AOS Release 6 CLI Reference Guide*.

- 4 Associate the profile with a user account. Enter the **user** command with the relevant username and password and specify **Profile1**. In this example, the user name is **Customer1** and the password is **my_passwd**:

```
-> user Customer1 password my_passwd end-user profile Profile1
```

For more information about creating a user and setting up a password, see [“Creating a User” on page 9-12](#). For information about creating end-user profiles, see [“Setting Up End-User Profiles” on page 9-25](#).

Note. *Optional.* To verify the user account, enter the [show user](#) command. The display is similar to the following:

```
User name = Customer1
  END user profile           = Profile1
  SNMP authentication        = NONE, Snmp encryption = NONE

User name = default
  END user profile           Profile5
  Snmp not allowed
```

For more information about the [show user](#) command, see the *OmniSwitch AOS Release 6 CLI Reference Guide*.

Default User Settings

The **default** user account on the switch is used for storing new user defaults for privileges and profile information. This account does not include a password and cannot be used to log into the switch.

At the first switch startup, the default user account is configured for:

- No read or write access
- No SNMP access
- No end-user profile

Any new users created on the switch will inherit the privileges or the end-user profile of the default user unless the user is configured with specific privileges or a profile.

The default user settings can be modified. Enter the **user** command with **default** as the user name. The default user can only store default functional privileges *or* a default end-user profile. The default user cannot be configured with both privileges and a profile.

The following example modifies the **default** user account with **read-write** access to all CLI commands:

```
-> user default read-write all
```

In this example, any new user that is created will have read and write access to all CLI commands (unless a specific privilege or SNMP access is configured for the new user). For more information about configuring privileges, see [“Setting Up End-User Profiles” on page 9-25](#).

The privilege default is particularly important for users who are authenticated via an ACE/Server, which only supplies username and password information; or for users who are authenticated via a RADIUS or LDAP server on which privileges are not configured. For more information about these servers, see the “Managing Authentication Servers” chapter of the *OmniSwitch AOS Release 6 Network Configuration Guide*.

Account and Password Policy Settings

The switch includes global password settings that are used to implement and enforce password complexity when a password is created, modified, and used. These user-configurable settings apply the following password requirements to all user accounts configured for the switch:

- Minimum password size
- Whether or not a password can contain the account username
- Minimum password character requirements
- Password expiration
- Password history
- Minimum password age

In addition to global password settings, the switch also includes global user lockout settings that determine when a user account is locked out of the switch and the length of time the user account remains locked.

See [“Configuring Password Policy Settings” on page 9-14](#) and [“Configuring Global User Lockout Settings” on page 9-18](#) for more information.

How User Settings Are Saved

Unlike other settings on the switch, user settings configured through the **password** command are saved to the switch configuration automatically. These settings are saved in real time in the local user database.

At bootup, the switch reads the database file for user information (rather than the **boot.cfg** file). The **write memory**, **copy running-config working**, or **configuration snapshot** commands are not *required* to save user or password settings over a reboot.

Note. Password settings configured through the **user password-policy** commands are not automatically saved to the switch configuration.

For information about using the **write memory**, **copy running-config working**, and **configuration snapshot** commands, see [Chapter 5, “Managing CMM Directory Content,”](#) [Chapter 7, “Working With Configuration Files,”](#) and the *OmniSwitch AOS Release 6 CLI Reference Guide*.

Creating a User

To create a new user, enter the **user** command with the desired username and password. Use the **password** keyword. For example:

```
-> user thomas password techpubs
```

In this example, a user account with a user name of **thomas** and a password of **techpubs** is stored in the local user database.

The password must be a string of non-repeating characters. The CLI uses the first occurrence of the character series to uniquely identify the password. For example, the password *tpubtpub* is the same as *tpub*. A better password might be *tpub3457*.

Note. The exclamation point (!) is not a valid password character. In addition, specifying an asterisk (*) as one or more characters in a password is allowed as long as every character is not an asterisk. For example, **password **123456**** is allowed; **password ******* is not allowed.

If privileges are not specified for the user, the user will inherit all of the privileges of the default user account. See [“Default User Settings” on page 9-9](#).

The password does not display in clear text in an ASCII configuration file produced by the **snapshot** command. Instead, it displays in encrypted form. See [Chapter 7, “Working With Configuration Files,”](#) for information about using the **snapshot** command.

While creating a user, **password-prompt** option can be used with the ‘user’ command to configure the password for the user. When this option is selected, a password prompt appears and the password can be provided. Password needs to be re-entered, and only if both the passwords match, command is accepted. Password provided in this mode is not displayed on the CLI as text.

For example,

```
-> user techpubs password-prompt
Password: *****
Re-enter password: *****
```

Removing a User

To remove a user from the local database, use the **no** form of the command:

```
-> no user thomas
```

The user account for **thomas** is removed from the local user database.

User-Configured Password

Users can change their own passwords by using the **password** command. In this example, the current user wants to change her password to **my_passwd**. Follow these steps to change the password:

- 1 Enter the **password** command. The system displays a prompt for the new password:

```
-> password
    enter old password:
```

- 2 Enter the old password. (The password is concealed with asterisks.) A prompt displays for the new password.

```
-> password
    enter old password:*****
    enter new password:
```

- 3 Enter the desired password. The system then displays a prompt to verify the password.

```
-> password
    enter old password:*****
    enter new password: *****
    reenter new password:
```

- 4 Enter the password again.

```
-> password
    enter old password:*****
    enter new password: *****
    reenter new password: *****
->
```

The password is now reset for the current user. At the next switch login, the user must enter the new password.

Note. A new password cannot be identical to the current password; it cannot be identical to any of the three passwords that preceded the current password. Also, the exclamation point (!) is not a valid password character and specifying an asterisk (*) as one or more characters in a password is allowed as long as every character is not an asterisk. For example, **password **123456**** is allowed; **password ******* is not allowed.

Configuring Password Policy Settings

The global password policy settings for the switch define the following requirements that are applied to all user accounts:

- Minimum password size.
- Whether or not the password can contain the username.
- The minimum number of uppercase characters required in a password.
- The minimum number of lowercase characters required in a password.
- The minimum number of base-10 digits required in a password.
- The minimum number of non-alphanumeric characters (symbols) required in a password.
- Password expiration.
- The maximum number of old passwords that are saved in the password history.
- The minimum number of days during which a user is not allowed to change their password.

Password policy settings are applied when a password is created or modified. The following subsections describe how to configure these settings using CLI commands.

To view the current policy configuration, use the **show user password-policy** command. For more information about this command and those used in the configuration examples throughout this section, see the *OmniSwitch AOS Release 6 CLI Reference Guide*.

Setting a Minimum Password Size

The default minimum password length (or size) is 8 characters. To configure a minimum password size, enter the **user password-size min** command. For example:

```
-> user password-size min 10
```

The minimum length for any passwords configured for users is now 10 characters.

The maximum password length is 31 characters.

Configuring the Username Password Exception

By default, specifying the username as all or part of a password is allowed. Use the **user password-policy cannot-contain-username** command to block the ability to configure a password that contains the username. For example:

```
-> user password-policy cannot-contain-username enable
```

Enabling this functionality prevents the user from specifying the username in the password that is configured for the same user account. For example, the password for the account username of **public** can not contain the word **public** in any part of the password. However, the username of another account is still allowed.

Configuring Password Character Requirements

The character requirements specified in the global password policy determine the minimum number of uppercase, lowercase, non-alphanumeric, and 10-base digit characters required in all passwords. These requirements are configured using the following **user password-policy** commands:

Command	Configures ...
user password-policy min-uppercase	The minimum number of uppercase characters required in all passwords.
user password-policy min-lowercase	The minimum number of lowercase characters required in all passwords.
user password-policy min-digit	The minimum number of base-10 digits required in all passwords.
user password-policy min-nonalpha	The minimum number of non-alphanumeric characters (symbols) required in all passwords.

Specifying zero with any of these commands disables the requirement. For example, if the number of minimum uppercase characters is set to zero (the default), then there is no requirement for a password to contain any uppercase characters.

Configuring Password Expiration

By default, password expiration is disabled on the switch. A global default password expiration can be specified for all users or password expiration can be set for an individual user.

Note. When the current user's password has less than one week before expiration, the switch will display an expiration warning after login.

If a user's password expires, the user will be unable to log into the switch through any interface; the **admin** user must reset the user's password. If the **admin** user's password expires, the admin user will have access to the switch through the console port with the currently configured password.

Default Password Expiration

To set password expiration globally, use the **user password-expiration** command with the desired number of days; the allowable range is 1 to 150 days. For example:

```
-> user password-expiration 3
```

The default password expiration is now set to three days. All user passwords on the switch will be set or reset with the three-day expiration. If an individual user was configured with a different expiration, the expiration will be reset to the global value.

The expiration is based on the switch system date/time and date/time the **user password-expiration** command is entered. For example, if a user is configured with a password expiration of 10 days, but the global setting is 20 days, that user's password will expire in 10 days.

To disable the default password expiration, use the **user password-expiration** command with the **disable** option:

```
-> user password-expiration disable
```

Specific User Password Expiration

To set password expiration for an individual user, use the **user password-expiration** command with the expiration keyword and the desired number of days or an expiration date. For example:

```
-> user bert password techpubs expiration 5
```

This command gives user **bert** a password expiration of five days.

To set a specific date for password expiration, include the date in *mm/dd/yyyy hh:mm* format. For example:

```
-> user bert password techpubs expiration 02/19/2003 13:30
```

This command sets the password expiration to February 19, 2003, at 1:30pm; the switch will calculate the expiration based on the system date/time. The **system date** and **system time** commands displays the system date and time information. For more information on the system date or time, see the *OmniSwitch AOS Release 6 Switch Management Guide*.

Note. The expiration will be reset to the global default setting (based on the **user password-expiration** command) if the user password is changed or the **user password-expiration** command is entered again.

Configuring the Password History

The password history refers to the number of old passwords for each user account that are saved by the switch. This functionality prevents the user from using the same password each time their account password is changed. For example, if the password history is set to 10 and a new password entered by the user matches any of the 10 passwords saved, then an error message is displayed notifying the user that the password is not available.

By default, the password history is set to save up to 4 old passwords for each user account. To configure the number of old passwords to save, use the `user password-history` command. For example:

```
-> user password-history 2
```

To disable the password history function, specify 0 as the number of old passwords to save. For example:

```
-> user password-history 0
```

A password is dropped from the password history when it no longer falls within the number of passwords that are retained by the switch.

Configuring the Minimum Age for a Password

The password minimum age setting specifies the number of days during which a user is not allowed to change their password. It is necessary to configure a password minimum age value that is less than the password expiration value.

The default minimum age is set to zero, which means that there is no minimum age requirement for a password. To configure a minimum password age, use the `user password-min-age` command. For example:

```
-> user password-min-age 7
```

This command specifies that the user is prevented from changing their password for seven days from the time the password was created or modified.

Configuring Global User Lockout Settings

The following user lockout settings configured for the switch apply to all user accounts:

- Lockout window—the length of time a failed login attempt is aged before it is no longer counted as a failed attempt.
- Lockout threshold—the number of failed login attempts allowed within a given lockout window period of time.
- Lockout duration—the length of time a user account remains locked until it is automatically unlocked.

In addition to the above lockout settings, the network administrator also has the ability to manually lock and unlock user accounts. The following subsections describe how to configure user lockout settings and how to manually lock and unlock user accounts.

Note. Only the **admin** user is allowed to configure user lockout settings. The **admin** account is protected from lockout; therefore, it is always available.

Lockout settings are saved *automatically*; that is, these settings do not require the **write memory**, **copy running-config working**, or **configuration snapshot** command to save user settings over a reboot. To view the current lockout settings configured for the switch, use the **show user lockout-setting** command.

For more information about this command and those used in the configuration examples throughout this section, see the *OmniSwitch AOS Release 6 CLI Reference Guide*.

Configuring the User Lockout Window

The lockout window is basically a moving observation window of time in which failed login attempts are counted. If the number of failed login attempts exceeds the lockout threshold setting (see “[Configuring the User Lockout Threshold Number](#)” on page 9-19) during any given observation window period of time, the user account is locked out of the switch.

If a failed login attempt ages beyond the observation window of time, that attempt is no longer counted towards the threshold number. For example, if the lockout window is set for 10 minutes and a failed login attempt occurred 11 minutes ago, then that attempt has aged beyond the lockout window time and is not counted. In addition, the failed login count is decremented when the failed attempt ages out.

By default, the lockout window is set to 0; this means that there is no observation window and failed login attempts are not counted. The user is allowed an unlimited number of failed login attempts. To configure the lockout window time, in minutes, use the **user lockout-window** command. For example:

```
-> user lockout-window 30
```

Do not configure an observation window time period that is greater than the lockout duration time period (see “[Configuring the User Lockout Duration Time](#)” on page 9-19).

Configuring the User Lockout Threshold Number

The lockout threshold number specifies the number of failed login attempts allowed during any given lockout window period of time (see [“Configuring the User Lockout Window” on page 9-18](#)). For example, if the lockout window is set for 30 minutes and the threshold number is set for 3 failed login attempts, then the user is locked out when 3 failed login attempts occur within a 30 minute time frame.

By default, the lockout threshold number is set to 0; this means that there is no limit to the number of failed login attempts allowed, even if a lockout window time period exists. To configure a lockout threshold number, use the **user lockout-threshold** command. For example:

```
-> user lockout-threshold 3
```

A locked user account is automatically unlocked when the lockout duration time (see [“Configuring the User Lockout Duration Time” on page 9-19](#)) is reached or the **admin** user manually unlocks the user account.

Configuring the User Lockout Duration Time

The user lockout duration time specifies the number of minutes a user account remains locked until it is automatically unlocked by the switch. This period of time starts when the user account is locked out of the switch. At any point during the lockout duration time, the **admin** user can still manually unlock the user account.

By default, the user lockout duration time is set to 0; this means that there is no automatic unlocking of a user account by the switch. The locked user account remains locked until it is manually unlocked by the **admin** user. To configure a lockout duration time, use the **user lockout-duration** command. For example:

```
-> user lockout-duration 60
```

Do not configure a lockout duration time that is less than the lockout window time period (see [“Configuring the User Lockout Window” on page 9-18](#)).

Manually Locking and Unlocking User Accounts

The **user lockout unlock** command is used to manually lock or unlock a user account. This command is only available to the **admin** user or a user who has read/write access privileges to the switch.

To lock a user account, enter **user lockout** and the username for the account. For example,

```
-> user lockout j_smith
```

To unlock a user account, enter **user unlock** and the username for the locked account. For example,

```
-> user unlock j_smith
```

In addition to this command, the **admin** user or users with read/write access privileges can change the user account password to unlock the account.

If a lockout duration time (see [“Configuring the User Lockout Duration Time” on page 9-19](#)) is not configured for the switch, then it is only possible to manually unlock a user account with the **user lockout** command or by changing the user password.

Configuring Privileges for a User

To configure privileges for a user, enter the **user** command with the **read-only** or **read-write** option and the desired CLI command domain names or command family names. The **read-only** option provides access to **show** commands; the **read-write** option provides access to configuration commands and show commands. Command families are subsets of command domains.

If you create a user without specifying any privileges, the user's account will be configured with the privileges specified for the default user account.

Command domains and families are listed here:

Domain	Corresponding Families
domain-admin	file telnet debug
domain-system	system aip snmp rmon webmgt config
domain-physical	chassis module interface pmm health
domain-network	ip rip ip-routing ipmr ipms rdp ipv6
domain-layer2	vlan bridge stp 802.1q linkagg ip-helper
domain-service	dns
domain-policy	qos policy
domain-security	session aaa

In addition to command families, the keywords **all** or **none** can be used to set privileges for all command families or no command families respectively.

An example of setting up user privileges:

```
-> user thomas read-write domain-network ip-helper telnet
```

User **thomas** will have write access to all the configuration commands and **show** commands in the network domain, as well as Telnet and IP helper (DHCP relay) commands. The user will not be able to execute any other commands on the switch.

Use the keyword **all** to specify access to all commands. In the following example, the user is given read access to all commands:

```
-> user lindy read-only all
```

Note. When modifying an existing user, the user password is not required. If you are configuring a new user with privileges, the password is required.

Use the keyword **all-except** to disable the function privileges for a specific family for a user. The following example creates a user with read-write privileges for all families except dshell.

```
-> user techpubs password writer read-write all-except dshell
```

The default user privileges can also be modified. See [“Default User Settings” on page 9-9](#).

Setting Up SNMP Access for a User Account

By default, users can access the switch based on the SNMP setting specified for the default user account. The **user** command, however, can be used to configure SNMP access for a particular user. SNMP access can be configured without authentication and encryption required (supported by SNMPv1, SNMPv2, or SNMPv3). Or the **user** command can be configured with authentication or authentication/encryption required (SNMPv3 only).

SNMP authentication specifies the algorithm that must be used for computing the SNMP authentication key. It can also specify AES or DES encryption. The following options can be configured for a user's SNMP access with authentication or authentication/encryption:

- **SHA**—The SHA authentication algorithm is used for authenticating SNMP PDU for the user.
- **MD5**—The MD5 authentication algorithm is used for authenticating SNMP PDU for the user.
- **SHA and DES**—The SHA authentication algorithm and DES encryption standard is used for authenticating and encrypting SNMP PDU for the user.
- **MD5 and DES**—The MD5 authentication algorithm and the DES encryption standard is used for authenticating and encrypting SNMP PDU for the user.
- **SHA and 3DES** — The SHA authentication algorithm and 3DES encryption standard is used for authenticating and encrypting SNMP PDU for the user.
- **SHA and AES**— The SHA authentication algorithm and AES encryption standard is used for authenticating and encrypting SNMP PDU for the user.
- **SHA and AES192**— The SHA authentication algorithm and AES192 encryption standard is used for authenticating and encrypting SNMP PDU for the user.
- **SHA and AES256**— The SHA authentication algorithm and AES256 encryption standard is used for authenticating and encrypting SNMP PDU for the user.
- **SHA224**— The SHA224 authentication algorithm is used for authenticating SNMP PDU for the user.
- **SHA224 and 3DES**— The SHA224 authentication algorithm and 3DES encryption standard is used for authenticating and encrypting SNMP PDU for the user.
- **SHA224 and AES**— The SHA224 authentication algorithm and AES encryption standard is used for authenticating and encrypting SNMP PDU for the user.
- **SHA224 and AES192**— The SHA224 authentication algorithm and AES192 encryption standard is used for authenticating and encrypting SNMP PDU for the user.
- **SHA224 and AES256**— The SHA224 authentication algorithm and AES256 encryption standard is used for authenticating and encrypting SNMP PDU for the user.
- **SHA256**— The SHA256 authentication algorithm is used for authenticating SNMP PDU for the user.
- **SHA256 and 3DES**— The SHA256 authentication algorithm and 3DES encryption standard is used for authenticating and encrypting SNMP PDU for the user.
- **SHA256 and AES**— The SHA256 authentication algorithm and AES encryption standard is used for authenticating and encrypting SNMP PDU for the user.
- **SHA256 and AES192**— The SHA256 authentication algorithm and AES192 encryption standard is used for authenticating and encrypting SNMP PDU for the user.

- **SHA256 and AES256**— The SHA256 authentication algorithm and AES256 encryption standard is used for authenticating and encrypting SNMP PDU for the user.

The user's level of SNMP authentication is superseded by the SNMP version allowed globally on the switch. By default, the switch allows all SNMP requests. Use the **snmp security** command to change the SNMP security level on the switch.

Note. At least one user with SHA/MD5 authentication and/or DES encryption must be configured on the switch for SNMPv3 communication with OmniVista.

The community string carried in the SNMP PDU identifies the request as an SNMPv1 or SNMPv2 request. The way the community string is handled on the switch is determined by the setting of the **snmp community map mode** command. If the community map mode is enabled, the community string is checked against the community strings database (populated by the **snmp community map** command). If the community map mode is disabled, then the community string value is checked against the user database. In either case, if the check fails, the request is dropped.

For more information about configuring SNMP globally on the switch, see [Chapter 3, “Using SNMP and OpenFlow.”](#)

The next sections describe how to configure SNMP access for users. Note the following:

- SNMP access cannot be specified for the **admin** user.
- When modifying a user's SNMP access, the user password must be re-entered (or a new one configured). This is required because the hash algorithm used to save the password in the switch depends on the SNMP authentication level.

SNMP Access Without Authentication/Encryption

To give a user SNMP access without SNMP authentication required, enter the **user** command with the **no auth** option. For example, to give existing user **thomas** SNMP access without SNMP authentication, enter the following:

```
-> user thomas password techpubs no auth
```

For this user, if the SNMP community map mode is enabled (the default), the SNMP community map must include a mapping for this user to a community string. In this example, the community string is **our_group**:

```
-> snmp community map our_group user thomas
```

In addition, the global SNMP security level on the switch must allow non-authenticated SNMP frames through the switch. By default, the SNMP security level is **privacy all**; this is the highest level of SNMP security, which allows only SNMPv3 frames through the switch. Use the **snmp security** command to change the SNMP security level. For more information about configuring SNMP globally on the switch, see [Chapter 3, “Using SNMP and OpenFlow.”](#)

SNMP Access With Authentication/Encryption

To configure a user with SNMP access and authentication, enter the **user** command with the desired authentication type (**sha**, **md5**, **sha+des**, and **md5+des**).

```
-> user thomas password techpubs sha+des
```

When SNMP authentication is specified, an SNMP authentication key is computed from the user password based on the authentication/encryption setting. In this example, the switch would use the SHA authentication algorithm and DES encryption on the **techpubs** password to determine the SNMP authentication key for this user. The key is in hexadecimal form and is used for encryption/de-encryption of the SNMP PDU.

The authentication key is only displayed in an ASCII configuration file if the **snapshot** command is entered. The key is indicated in the file by the syntax **authkey key**. See [Chapter 7, “Working With Configuration Files,”](#) for information about using the **snapshot** command. The key is not displayed in the CLI.

Removing SNMP Access From a User

To deny SNMP access, enter the **user** command with the **no snmp** option:

```
-> user thomas no snmp
```

This command results in **thomas** no longer having SNMP access to manage the switch.

Setting Up End-User Profiles

End-user profiles are designed for user accounts in the carrier market. With end-user profiles, a network administrator can configure customer login accounts that restrict users to particular command areas over particular ports and/or VLANs.

End-user profiles are only managed and stored on the switch; profiles are not stored on external servers.

Note. End-user profiles cannot be used in conjunction with user partitioned management; the features are mutually exclusive.

The following table shows the end-user command areas and the commands associated with each area:

Area Keyword	Available Commands
physical	flow flow wait interfaces interfaces admin interfaces alias interfaces no L2 statistics trap port link show interfaces
vlan-table	vlan vlan 802.1q vlan 802.1q frame type vlan 802.1q force tag internal vlan authentication vlan binding mac-ip-port vlan binding mac-port-protocol vlan binding mac-port vlan binding mac-ip vlan binding ip-port vlan dhcp mac vlan dhcp mac range vlan dhcp port vlan dhcp generic vlan mac vlan mac range vlan ip vlan port default vlan protocol vlan port vlan port mobile vlan port default vlan restore vlan port authenticate vlan stp vlan user show 802.1q show vlan rules show vlan port mobile show vlan show vlan port show vlan router mac status
mac-filtering-table	mac-address-table mac-address-table aging-time show mac-address-table show mac-address-table count show mac-address aging-time
spantree	show spantree show spantree ports
basic-ip-routing	show arp
ip-routes-table	show ip route

Creating End-User Profiles

To set up an end-user profile, use the `aaa admin-logout` command and enter a name for the profile. Specify read-only or read-write access to particular command areas. The profile can also specify port ranges and/or VLAN ranges. The port ranges and VLAN ranges must be configured on separate command lines and are discussed in the next sections.

In this example, a profile is created with access to physical commands on the switch:

```
-> end-user profile Profile3 read-write physical
```

A profile named **Profile3** is now available on the switch and can be associated with a user through the `user` command.

If port ranges or VLAN ranges are not configured, a user with this profile will not be able to use any commands that require port or VLAN values or view any `show` outputs that contain port or VLAN values.

Setting Up Port Ranges in a Profile

To set up port ranges for a profile, enter the `end-user profile port-list` command with the relevant profile name and the desired slots/ports. For example:

```
-> end-user profile Profile3 port-list 2 3/1-4
```

In this example, the port list includes all ports in slot 2, and ports 1 through 4 on slot 3. A user with this profile will be able to manage these ports (depending on the command areas specified in the profile).

To remove a port list, use the `no` form of the command with the relevant slot number(s). All ports in the port list on a given slot will be removed. For example:

```
-> end-user profile Profile3 no port-list 3
```

In this example, all ports on slot 3 are removed from the profile.

Setting Up VLAN Ranges in a Profile

To set up VLAN ranges for a profile, enter the `end-user profile vlan-range` command with the relevant profile name and the desired VLAN range. For example:

```
-> end-user profile Profile3 vlan-range 2-4 7-8
```

In this example, the VLAN range includes VLANs 2, 3, 4, 7, and 8. A user with this profile will be able to manage these VLANs (depending on the command areas specified in the profile).

To remove a VLAN range from a profile, use the `no` form of the command and the VLAN ID of the start of the range to be removed. For example:

```
-> end-user profile Profile3 no vlan-range 7
```

This command removes VLANs 7 and 8 from Profile3.

Associating a Profile With a User

To associate a profile with a user, enter the **user** command with the **end-user profile** keywords and the relevant profile name. For example:

```
-> user Customer2 end-user profile Profile3
```

Profile3 is now associated with Customer2. When Customer2 logs into the switch, Customer2 will have access to command areas, port ranges, and VLAN ranges specified by Profile3.

The user information stored on an external server can include a profile name. When the user attempts to log into the switch, the switch will attempt to match the profile name to a profile stored on the switch.

Removing a Profile From the Configuration

To delete a profile from the configuration, enter the **no** form of the **end-user profile** command with the name of the profile you want to delete. For example:

```
-> no end-user profile Profile3
```

Profile3 is deleted from the configuration.

Note. If the profile name is associated with a user, and the profile is deleted from the configuration, the user will not have access to the switch.

Verifying the User Configuration

To display information about user accounts configured locally in the user database, use the **show** commands listed here:

show user	Displays information about all users or a particular user configured in the local user database on the switch.
show user password-size	Displays the minimum number of characters that are required for a user password.
show user password-expiration	Displays the expiration date for passwords configured for user accounts stored on the switch.
show user password-policy	Displays the global password settings configured for the switch.
show user lockout-setting	Displays the global user lockout settings configured for the switch.
show end-user profile	Displays information about end-user profiles.
show aaa classification-rule	Displays hexadecimal values for command domains/families.

For more information about the resulting displays from these commands, see the *OmniSwitch AOS Release 6 CLI Reference Guide*. An example of the output for the **show user** command is also given in “Quick Steps for Network Administrator User Accounts” on page 9-7.

10 Managing Switch Security

Switch security is provided on the switch for all available management interfaces (console, Telnet, HTTP, FTP, Secure Shell, and SNMP). The switch can be set up to allow or deny access through any of these interfaces.

Note. Users attempting to access the switch must have a valid username and password.

In This Chapter

This chapter describes how to set up switch management interfaces through the Command Line Interface (CLI). CLI commands are used in the configuration examples; for more details about the syntax of commands, see the *OmniSwitch AOS Release 6 CLI Reference Guide*.

An overview of switch security is given in this chapter. In addition, configuration procedures described in this chapter include:

- [“Configuring Authenticated Switch Access” on page 10-6](#)
- [“Setting Up Management Interfaces for ASA” on page 10-9](#)
- [“Configuring Accounting for ASA” on page 10-12](#)
- [“Authenticated Switch Access - Enhanced Mode” on page 10-14](#)

For more information about the resulting displays from these commands, see the *OmniSwitch AOS Release 6 CLI Reference Guide*. An example of the output for the show aaa authentication command is also given in [“Quick Steps for Setting Up ASA” on page 10-7](#).

A user login procedure requires that users are authenticated for switch access via an external authentication server or the local user database. For information about setting up user accounts locally on the switch, see [Chapter 9, “Managing Switch User Accounts.”](#) For information about setting up external servers that are configured with user information, see the “Managing Authentication Servers” chapter in the *OmniSwitch AOS Release 6 Network Configuration Guide*.

This chapter describes how to enable/disable access for management interfaces. For information about basic login on the switch, see [Chapter 2, “Logging Into the Switch.”](#)

Switch Security Specifications

The following table describes the maximum number of sessions allowed on an OmniSwitch:

Session	OmniSwitch 6350, 6450
Telnet (v4 or v6)	4
FTP (v4 or v6)	4
SSH + SFTP (v4 or v6 secure sessions)	8
HTTP	4
Total Sessions	20
SNMP	50

Note. An IPv6 client session for Telnet, FTP, SSH, SFTP, and SNMP is supported on an OmniSwitch 6350, 6450.

Switch Security Defaults

Access to managing the switch is always available for the **admin** user through the console port, even if management access to the console port is disabled for other users.

Switch Security Overview

Switch security features increase the security of the basic switch login process by allowing management only through particular interfaces for users with particular privileges. Login information and privileges can be stored on the switch and/or an external server, depending on the type of external server you are using and how you configure switch access.

The illustration here shows the components of switch security:

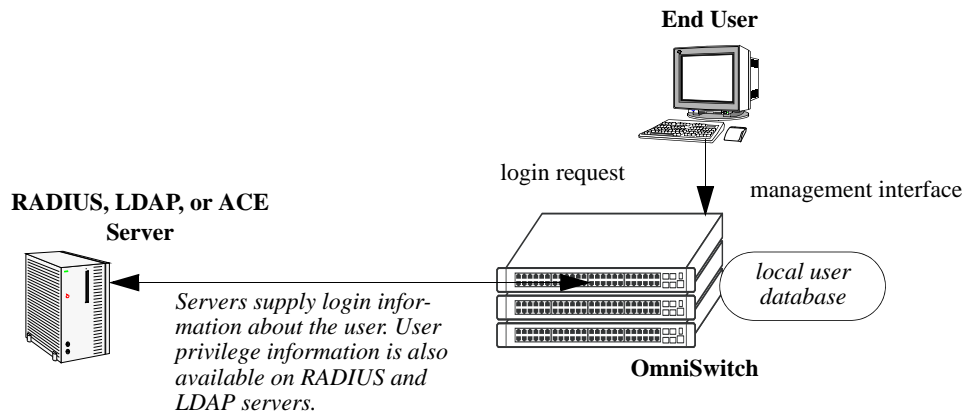

Authenticated Switch Access Setup

An external RADIUS or LDAP server can supply both user login and authorization information. ACE/Server can provide login information; user authorization information is available through the switch's local user database. External servers can also be used for accounting, which includes logging statistics about user sessions. For information about configuring the switch to communicate with external servers, see the "Managing Authentication Servers" chapter in the *OmniSwitch AOS Release 6 Network Configuration Guide*.

If an external server is not available or is not configured, user login information and user authorization can be provided through the local user database on the switch. The user database is described in [Chapter 9, "Managing Switch User Accounts."](#)

Logging can also be accomplished directly on the switch. For information about configuring local logging for switch access, see "[Configuring Accounting for ASA](#)" on page 10-12. For complete details about local logging, see the "Using Switch Logging" chapter in the *OmniSwitch AOS Release 6 Network Configuration Guide*.

Authenticated Switch Access

Authenticated Switch Access (ASA) is a way of authenticating users who want to manage the switch. With authenticated access, all switch login attempts using the console or modem port, Telnet, FTP, SNMP, or HTTP require authentication via the local user database or via a third-party server.

This section describes how to configure management interfaces for authenticated access as well as how to specify external servers that the switch can poll for login information. The type of server can be an authentication-only mechanism or an authentication, authorization, and accounting (AAA) mechanism.

AAA Servers—RADIUS or LDAP

AAA servers are able to provide authorization for switch management users as well as authentication (they also can be used for accounting). The AAA servers supported on the switch are Remote Authentication Dial-In User Service (RADIUS) or Lightweight Directory Access Protocol (LDAP) servers. User login information and user privileges can be stored on the servers.

Privileges are used for *network administrator accounts*. Instead of user privileges an end-user profile can be associated with a user for *customer login accounts*. User information configured on an external server can include a profile name attribute. The switch will attempt to match the profile name to a profile stored locally on the switch.

The following illustration shows the two different user types attempting to authenticate with a AAA server:

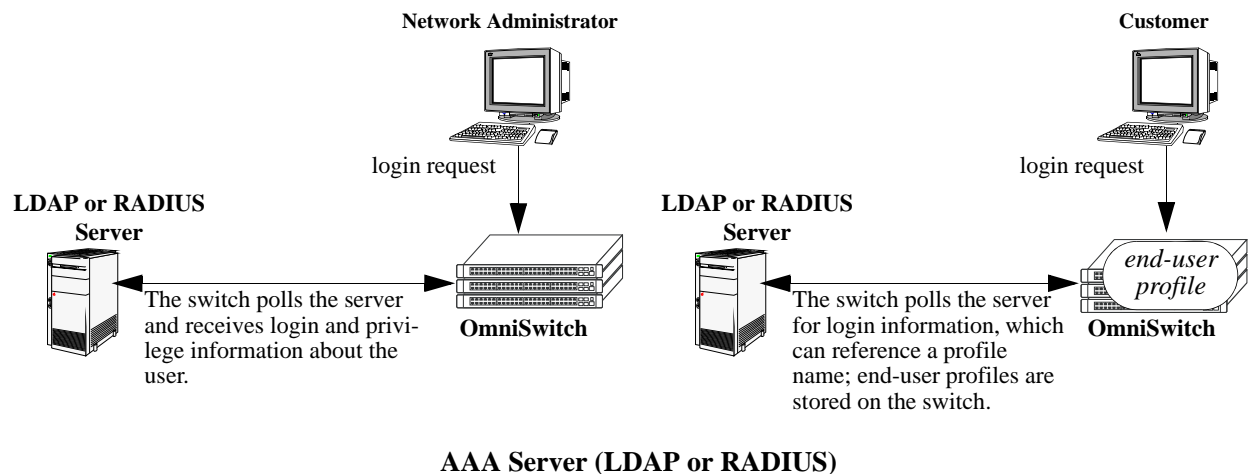

For more information about types of users, see [Chapter 9, “Managing Switch User Accounts.”](#)

Authentication-only—ACE/Server

Authentication-only servers are able to authenticate users for switch management access, but authorization (or what privileges the user has after authenticating) are determined by the switch. Authentication-only servers cannot return user privileges or end-user profiles to the switch. The authentication-only server supported by the switch is ACE/Server, which is a part of RSA Security’s SecurID product suite. RSA Security’s ACE/Agent is embedded in the switch.

The following illustration shows the two different user types attempting to authenticate with an ACE/Server:

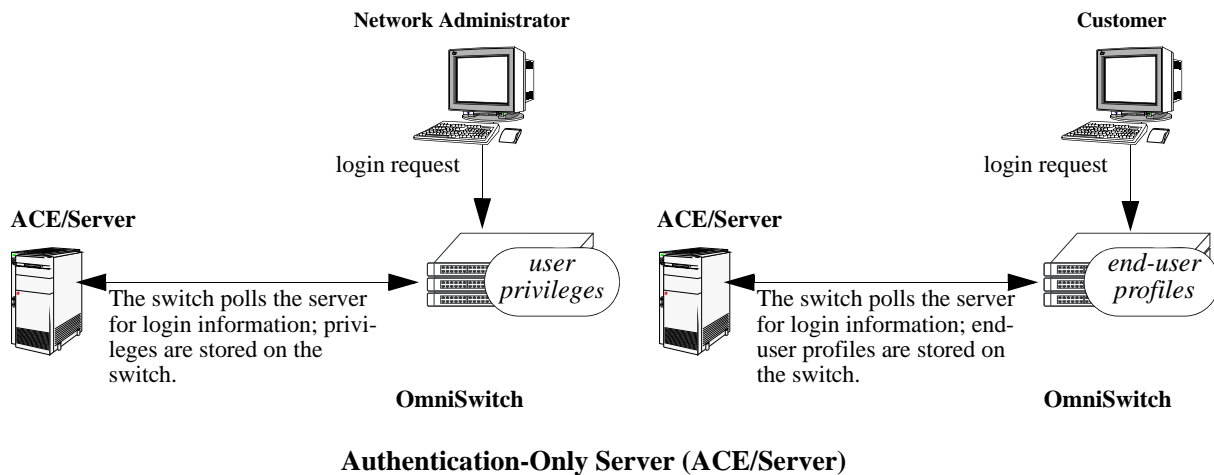

Note. A RADIUS server supporting the challenge and response mechanism as defined in RADIUS RFC 2865 can access an ACE/Server for authentication purposes. The ACE/Server is then used for user authentication, and the RADIUS server is used for user authorization.

Interaction With the User Database

By default, switch management users can be authenticated through the console port via the local user database. If external servers are configured for other management interfaces (such as Telnet, or HTTP), but the servers become unavailable, the switch will poll the local user database for login information.

Access to the console port provides secure failover in case of misconfiguration or if external authentication servers become unavailable. The **admin** user is always authorized through the console port via the local database (provided the correct password is supplied), even if access to the console port is disabled.

The database includes information about whether or not a user is able to log into the switch and which kinds of privileges or rights the user has for managing the switch. The database can be set up by the **admin** user or any user with write privileges to the AAA commands.

See [Chapter 9, “Managing Switch User Accounts,”](#) for more information about setting up the user database.

ASA and Authenticated VLANs

Layer 2 Authentication uses Authenticated VLANs to authenticate users *through the switch* out to a subnet. Authenticated Switch Access authenticates users *into the switch* to manage it. The features are independent of each other; however, user databases for each feature can be located on the same authentication server.

For more information on authenticated VLANs, and authentication servers, see “Configuring Authenticated VLANs” and “Configuring Authentication Servers” in the *OmniSwitch AOS Release 6 Network Configuration Guide*.

Configuring Authenticated Switch Access

Setting up Authenticated Switch Access involves the following general steps:

- 1 Set Up the Authentication Servers.** This procedure is described briefly in this chapter. See the “Managing Authentication Servers” chapter of the *OmniSwitch AOS Release 6 Network Configuration Guide* for complete details.
- 2 Set Up the Local User Database.** Set up user information on the switch if user login or privilege information will be pulled from the switch. See [Chapter 9, “Managing Switch User Accounts.”](#)
- 3 Set Up the Management Interfaces.** This procedure is described in “[Setting Up Management Interfaces for ASA](#)” on page 10-9.
- 4 Set Up Accounting.** This step is optional and is described in “[Configuring Accounting for ASA](#)” on page 10-12.

Additional configuration is required to set up the switch to communicate with external authentication servers. This configuration is briefly mentioned in this chapter and described in detail in the “Managing Authentication Servers” chapter of the *OmniSwitch AOS Release 6 Network Configuration Guide*.

If you are using the local switch database to authenticate users, user accounts must be set up on the switch. Procedures for creating user accounts are described in this chapter. See [Chapter 9, “Managing Switch User Accounts.”](#)

Note that by default:

- Authenticated switch access is available only through the console port.
- Users are authenticated through the console port via the local user database on the switch.

These defaults provide “out-of-the-box” security at initial startup. Other management interfaces (Telnet, HTTP, and so on.) must be specifically enabled before they can access the switch.

A summary of the commands used for configuring ASA is given in the following table:

Commands	Used for..
aaa radius-server aaa tacacs+-server	Setting up the switch to communicate with external RADIUS or LDAP authentication servers.
aaa authentication	Configuring the management interface and specifying the servers and/or local user database to be used for the interface.
aaa accounting mac	<i>Optional.</i> Specifies servers to be used for accounting.

Quick Steps for Setting Up ASA

1 If the local user database is used for user login information, set up user accounts through the **user** command. User accounts includes user privileges or an end-user profile. In this example, user privileges are configured:

```
-> user thomas password pubs read-write domain-network ip-helper telnet
```

If SNMP access is configured for the user, the global SNMP setting for the switch can be configured through the **snmp security** command. See [Chapter 9, “Managing Switch User Accounts,”](#) for more information about setting up user accounts.

2 If an external RADIUS or LDAP server will be used for user login information, use the **aaa radius-server** or **aaa tacacs+-server** commands to configure the switch to communicate with these servers. For example:

```
-> aaa radius-server rad1 host 10.10.1.2 timeout 3
```

For more information, see the “Managing Authentication Servers” chapter in the *OmniSwitch AOS Release 6 Network Configuration Guide*.

3 Use the **aaa authentication** command to specify the management interface through which switch access is permitted (such as **console**, **telnet**, **ftp**, **http**, or **ssh**). Specify the server and backup servers to be used for checking user login and privilege information. Multiple servers of different types can be specified. For example:

```
-> aaa authentication telnet rad1 ldap2 local
```

The order of the server names is important. The switch uses the first available server in the list. In this example, the switch would use **rad1** to authenticate Telnet users. If **rad1** becomes unavailable, the switch will use **ldap2**. If **ldap2** then becomes unavailable, the switch will use the local user database to authenticate users.

4 Repeat step 3 for each management interface to which you want to configure access; or use the **default** keyword to specify access for all interfaces for which access is not specifically denied. For example, if you want to configure access for all management interfaces except HTTP, you would enter:

```
-> no aaa authentication http
-> aaa authentication default rad1 local
```

Note the following:

- SNMP access can only use LDAP servers or the local user database. If you configure the default management access with only RADIUS and/or ACE, SNMP will not be enabled.
- It is recommended that Telnet and FTP be disabled if Secure Shell (**ssh**) is enabled.
- If you want to use WebView to manage the switch, make sure HTTP is enabled.

5 Specify an accounting server if a RADIUS or LDAP server will be used for accounting. Specify **local** if accounting can be done on the switch through the Switch Logging feature. Multiple servers can be specified as backups.

```
-> aaa accounting session ldap2 local
```

The order of the server names is important here as well. In this example, the switch will use **ldap2** for logging switch access sessions. If **ldap2** becomes unavailable, the switch will use the local Switch Logging facility. For more information about Switch Logging, see the *OmniSwitch AOS Release 6 Network Configuration Guide*.

Note. To verify the switch access setup, enter the **show aaa authentication** command. The display is similar to the one shown here:

```
Service type = Default
  1rst authentication server  = rad1
  2nd authentication server  = local
Service type = Console
  Authentication = Use Default,
  1rst authentication server  = rad1
  2nd authentication server  = local
Service type = Telnet
  Authentication = Use Default,
  1rst authentication server  = rad1
  2nd authentication server  = local
Service type = Ftp
  Authentication = Use Default,
  1rst authentication server  = rad1
  2nd authentication server  = local
Service type = Http
  Authentication = denied
Service type = Snmp
  Authentication = Use Default,
  1rst authentication server  = rad1
  2nd authentication server  = local
Service type = Ssh
  Authentication = Use Default,
  1rst authentication server  = rad1
  2nd authentication server  = local
```

For more information about this command, see the *OmniSwitch AOS Release 6 CLI Reference Guide*.

Setting Up Management Interfaces for ASA

By default, authenticated access is available through the console port. Access through other management interfaces is disabled. Other management interfaces include Telnet, FTP, HTTP, Secure Shell, and SNMP. This chapter describes how to set up access for management interfaces. For more details about particular management interfaces and how they are used, see [Chapter 2, “Logging Into the Switch.”](#)

To give switch access to management interfaces, use the **aaa authentication** command to allow or deny access to each interface type; the **default** keyword can be used to configure access for all interface types. Specify the server(s) to be used for authentication through the indicated management interface.

Keywords used for specifying management interfaces are listed here:

keywords

console	ssh
telnet	snmp
ftp	default
http	

Note that **ssh** is the keyword used to specify Secure Shell.

To specify an external authentication server or servers, use the RADIUS or LDAP server name or the keyword **ace** for an ACE/Server. To specify that the local user database must be used for authentication, use the **local** keyword. Up to four servers can be specified.

RADIUS and LDAP servers are set up to communicate with the switch via the **aaa radius-server** and **aaa tacacs+-server** commands. ACE/Servers do not require any configuration, but you must FTP the **sdconf.rec** file from the server to the switch’s **network** directory. For more information about configuring the switch to communicate with these servers, see the “Managing Authentication Servers” chapter of the *OmniSwitch AOS Release 6 Network Configuration Guide*.

Note. RADIUS or LDAP servers used for authenticated switch access can also be used with authenticated VLANs. Authenticated VLANs are described in the “Configuring Authenticated VLANs” chapter of the *OmniSwitch AOS Release 6 Network Configuration Guide*.

The order of the specified servers is important. The switch uses only one server for authentication—the first available server in the list. All authentication attempts will be tried on that server. Other servers are not tried, even if they are available. If **local** is specified, it must be last in the list since the local user database is always available when the switch is up.

Servers can also be used for accounting, or logging, of authenticated sessions. See [“Configuring Accounting for ASA” on page 10-12](#).

The following table describes the management access interfaces or methods and the types of authentication servers that can be used with them:

Server Type	Management Access Method
RADIUS	Telnet, FTP, HTTP, Secure Shell
LDAP	Telnet, FTP, HTTP, Secure Shell, SNMP
ACE/Server	Telnet, FTP, HTTP, Secure Shell
local	console, FTP, HTTP, Secure Shell, SNMP

Enabling Switch Access

Enter the **aaa authentication** command with the relevant keyword that indicates the management interface and specify the servers to be used for authentication. In this example, Telnet access for switch management is enabled. Telnet users will be authenticated through a chain of servers that includes a RADIUS server and an LDAP server that have already been configured through the **aaa radius-server** and **aaa ldap-server** commands respectively. For example:

```
-> aaa authentication telnet rad1 ldap2 local
```

After this command is entered, Telnet users will be authenticated to manage the switch through the **rad1** RADIUS server. If that server is unavailable, the LDAP server, **ldap2**, will be polled for user information. If that server is unavailable, the local user database will be polled for user information. If the local user database is specified, it must be last in the list of servers.

To disable authenticated access for a management interface use the **no** form of the command with the keyword for the interface. For example:

```
-> no aaa authentication ftp
```

FTP access is now denied on the switch.

Note. The **admin** user always has switch access through the console port even if access is denied through the console port.

To remove a server from the authenticated switch access configuration, enter the **aaa authentication** command with the relevant server names (s) and leave out the names of any servers you want to remove. For example:

```
-> aaa authentication telnet rad1 local
```

The server **ldap2** is removed for Telnet access and will not be polled for user information when users attempt to log into the switch through Telnet.

Note. SNMP can only use LDAP servers or the local user database for authentication.

Configuring the Default Setting

The **default** keyword can be used to specify the default setting for all management interfaces except those that have been explicitly denied. For example:

```
-> no aaa authentication ftp
-> aaa authentication default ldap2 local
```

In this example, all management interfaces except FTP are given switch access through **ldap2** and the local user database.

Since SNMP can only use LDAP servers or the local database for authentication, RADIUS or ACE/Server are not valid servers for SNMP management access. If the default interface setting includes only RADIUS and/or ACE server, the default setting will not be used for SNMP. For example:

```
-> no aaa authentication ftp
-> aaa authentication default rad1 rad2
```

In this scenario, SNMP access is *not enabled* because only RADIUS servers have been included in the default setting. If servers of different types are configured and include LDAP or **local**, SNMP will be enabled through those servers. For example:

```
-> aaa authentication default rad1 ldap2 local
```

In this case, SNMP access is enabled, and users will be authenticated through **ldap2** and the local database.

The **default** keyword can also be used to reset a specified interface to the default interface setting. For example:

```
-> aaa authentication telnet default
```

In this example, Telnet users will now be authenticated through the servers that are specified for the default interface.

Using Secure Shell

Secure Shell is recommended instead of Telnet and FTP as a method for accessing the switch. (Telnet and FTP are not secure.) Secure Shell contains a secure FTP application that can be used after a Secure Shell session is initiated. If Secure Shell is enabled, it is recommended that Telnet and FTP be disabled. For example:

```
-> no aaa authentication telnet
-> no aaa authentication ftp
-> aaa authentication ssh rad1 ldap2 local
```

In addition to enabling Secure Shell on the switch, you can replace the DSA key on the switch. The DSA key is generated at initial switch startup and copied to the secondary CMM; it includes a private key that generates a digital signature against a public key. The Secure Shell client will verify this signature when the client attempts to log into the switch.

The DSA key on the switch is made up of two files contained in the **/flash/network** directory; the public key is called **ssh_host_dsa_key.pub**, and the private key is called **ssh_host_dsa_key**. To generate a different DSA key, use the Secure Shell tools available on your Unix or Windows system and copy the files to the **/flash/network** directory.

For more information about Secure Shell, see [Chapter 2, “Logging Into the Switch.”](#)

Note. Secure Shell cannot be used for Authenticated VLANs.

Configuring Accounting for ASA

Accounting servers track network resources such as time, packets, bytes, and user activity (when a user logs in and out, how many login attempts were made, session length, and so on.). The accounting servers can be located anywhere in the network.

Note the following:

- Up to four servers can be configured.
- The servers can be of different types.
- ACE cannot be used as an accounting server.
- The keyword **local** must be specified if you want accounting to be performed via the Switch Logging feature in the switch. If **local** is specified, it must be the last server in the list.

External accounting servers are configured through the **aaa radius-server** and **aaa tacacs+-server** commands. These commands are described in “Managing Authentication Servers” in the *OmniSwitch AOS Release 6 Network Configuration Guide*.

To enable accounting (logging a user session) for Authenticated Switch Access, use the **aaa accounting mac** command with the relevant server name(s). In this example, the RADIUS and LDAP servers have already been configured through the **aaa radius-server** and **aaa ldap-server** commands.

```
-> aaa accounting session rad1 ldap2 local
```

After this command is entered, accounting will be performed through the **rad1** RADIUS server. If that server is unavailable, the LDAP server, **ldap2**, will be used for accounting. If that server is unavailable, logging will be done locally on the switch through the Switch Logging feature. (For more information about Switch Logging, see the *OmniSwitch AOS Release 6 Network Configuration Guide*.)

To remove an individual server from the list of servers, enter the **aaa accounting session** command with the relevant server name(s), removing the desired server from the list. For example:

```
-> aaa accounting session rad1 local
```

The server **ldap2** is removed as an accounting server.

To disable accounting for Authenticated Switch Access, use the **no** form of the **aaa accounting session** command:

```
-> no aaa accounting session
```

Accounting will not be performed for Authenticated Switch Access sessions.

Enabling or Disabling Console Session

Console session helps in security-sensitive networks and deployments. The option manages the access to the switch configuration shell through the console port.

The feature allows the following operations:

- Enable or disable the access to the switch configuration shell through the console port.
- Allows storing the configuration in the configuration file so that even after a reboot, the access to the switch remains through console port.

Use the command **session console** to enable the switch access through the console port through the CLI shell. Example:

```
-> session console enable
```

Use the command **session console** to disable the switch access through the console port through the CLI shell. Example:

```
-> session console disable
```

However, When the command is disabled, only the console on the primary switch is disabled and not the console on the secondary switch or the idle switch.

To view the status of the CLI console shell use the command **show session config**.

To display information about CLI console shell status, use the **show** command listed here:

show session config	Displays session manager configuration information (for example, default prompt, banner file name, inactivity timer, login timer, CLI console shell status and login attempts).
----------------------------	---

For more information on command usage and the resulting displays, refer chapter Session Management Commands in *OmniSwitch AOS Release 6 CLI Reference Guide*.

If this command is disabled and the telnet, SSH or webview access to the switch is also lost please contact customer support.

Note. Deleting configuration file will also delete the other configurations. Hence, it is recommended to create a back-up of the configuration file before deleting the configuration file.

Authenticated Switch Access - Enhanced Mode

Authenticated Switch Access - Enhanced Mode feature allows configuration of enhanced security restrictions to the OmniSwitch.

Configuring the ASA Mode

Set the access mode to enhanced or default mode by using the `aaa switch-access mode` command. Enhanced mode enables enhanced set of security options for switch access.

ASA mode is not enabled by default or when the switch is in the factory default state. The mode must first be activated through CLI through console access with default username and password (admin/switch). However, to avoid this initial CLI command, the new mode can also be activated by creating 'asaAdvancedMode.cfg' file in the /flash/switch directory.

Note. It is recommended to save the configuration and reboot the switch when the ASA access mode is configured.

For example, the following command sets the access mode to default.

```
-> aaa switch-access mode default
```

The following command sets the access mode to enhanced mode.

```
-> aaa switch-access mode enhanced
```

The following functionality come into effect when the ASA mode is enabled:

- When the enhanced mode is initially activated, the default password-policy and lockout settings are automatically set to enhanced mode default values. When the switch boots up with a boot.cfg configuration file that has the enhanced ASA mode activated, LockoutSetting file will be considered for the modified lockout settings as the modified values will not be stored in boot.cfg.
- Default password **switch** cannot be set anymore as it does not meet the enhanced mode password policy. User 'admin' shall be forced to change the password upon login.
- The following table lists the factory default and the ASA enhanced mode values for password policy and user lockout parameters:

Parameters	ASA enhanced mode default values	Factory default values
User password-size-min	9	8
User-password-expiration	Disabled	Disabled
User password-policy-cannot-contain-username	Disabled	Disabled
User password-policy min-upper-case	1	0
User password-policy-min-lower-case	1	0
User password-policy-min-digit	1	0
User password-policy-min-nonalpha	1	0

Parameters	ASA enhanced mode default values	Factory default values
User password-history	4	4
User password-min-age	0	0
User lockout-window	1 minute	0
User lockout-duration	5 minutes	0
User lockout-threshold	3	0 (Disabled)

- If the mode is changed from default to enhanced and if the user password policy settings and the user lockout settings have the default mode default values, then corresponding enhanced mode default values will be assigned. If the user password policy settings and the user lockout settings are assigned with non-default values in the default mode, then the same values will be carried to the enhanced mode. If the mode is changed from enhanced to default, the user password policy settings and user lockout settings assigned during enhanced mode will be kept unchanged.
- In enhanced mode, a given user is restricted to only one session. For example, if a user 'admin' has already logged in a session, another session with the same user 'admin' is not allowed, and the new session login is refused. This is applicable for both local and external users.
For example:

```
login: admin
password: *****
Account already in use.
```

This login failure attempt is not considered as an invalid login attempt for lockout count as this check is done before the login request reaches AAA.

- When the enhanced mode is activated, other existing sessions will not be logged out. The change of password for internal or external user will not impact existing sessions until they log out.
- When the ASA mode is set to enhanced or default, the changes will take effect in secondary after write memory flash-synchro.
- When the mode is changed from enhanced to default, the configurations affected by the enhanced mode will continue to exist on the switch.
- When enhanced mode is activated, any local user who logs in with the password that does not comply with the enhanced mode password policy, the user will be prompted to change the password.
- ASA enhanced mode allows the dynamic alignment of IP services like telnet, FTP, SSH, to the AAA authentication status. Other IP services except console access is disabled. However, existing command **[no] ip service** can be used to enable or disable individual IP services.
- In the enhanced mode, a user account will be locked after the authentication failure based on the threshold value within the observation window duration, irrespective of the access method. The user account will remain locked for the lockout duration (lockout-window, lockout-threshold, and lockout-duration is based on the configured or default values.) This is only supported for local users.
- AOS shall support both DSA 1024 and RSA 2048 public key algorithms for SSH in enhanced mode.
- Viewing of SSH public and SSH private key files on the console using **vi** or **more** commands is not allowed in enhanced mode.

- RSA 2048 public/private key pair will be generated in "/flash/network" directory (if not already present) when the switch reboots after enabling enhanced mode.
- Webview access supports connection over TLS. In the enhanced mode, the default certificates are generated with RSA 2048 bit keys.
- When enhanced mode is activated, TLS connections use only TLS 1.2 version. Connection requests with TLS version 1.1 and lower shall be rejected. Support for TLS 1.2 version would require a switch reboot after enabling enhanced mode. After reboot, TLS exchange shall use only TLS 1.2 version.
- When the switch is in ASA enhanced mode, both user name and password is prompted to view the SWLOG data when **show log swlog**, **vi swlog.log**, **more swlog.log** commands are used by the users. Only those users who provide valid ASA credentials are allowed to view the data. For more information on the switch logging commands, refer chapter Switch Logging Commands in *OmniSwitch AOS Release 6 CLI Reference Guide*.

Configuring the IP Lockout Threshold Value

The lockout threshold number specifies the number of failed login attempts from an IP address after which the IP address will be banned from switch access.

By default, the lockout threshold value is set to 6. To configure a lockout threshold number, use the **aaa switch-access ip-lockout-threshold** command. For example:

```
-> aaa switch-access ip-lockout-threshold 2
```

IP address is permanently blocked/banned if the number of authentication failures from a particular IP equals or exceeds IP lockout threshold limit. A maximum of 128 IPs will be added to the banned list. When the maximum limit has reached, oldest entry from the list is removed to accommodate the new entries.

Unlock/Release Banned or Locked IP

To release the banned IP addresses that are blocked due to failed login attempts, use the **aaa switch-access banned-ip release** command. For example:

```
-> aaa switch-access banned-ip all release  
-> aaa switch-access banned-ip 100.2.45.56 release
```

Configuring Privileges for an Access Type

The access privileges for the SSH, TELNET, Console, HTTP, HTTPS can be defined with the **read-only** or **read-write** option and the desired CLI command domain names or command family names. The read-only option provides access to show commands; the read-write option provides access to configuration commands and show commands. Command families are subsets of command domains.

Possible values for domains and families are listed in the table here:

Domain	Corresponding Families
domain-admin	file telnet dshell debug
domain-system	system aip snmp rmon webmgt config
domain-physical	chassis module interface pmm health
domain-network	ip rip ospf bgp vrrp ip-routing ipmr ipms
domain-layer2	vlan bridge stp 802.1q linkagg ip-helper
domain-service	dns
domain-policy	qos policy slb
domain-security	session avlan aaa

In addition to command families, the keywords **all** or **none** can be used to set privileges for all command families or no command families respectively. And, use the **all-except** keyword to disable functional privileges for specific families for an access type.

An example of setting up access type privileges:

```
-> aaa switch-access priv-mask ssh read-write ripng rip rdp qos port-mapping pmm
```

Use the keyword **all** to specify that all command families and domains are available to the user for a specific access type.

```
-> aaa switch-access priv-mask ssh read-write all
```

Use the keyword **all-except** to disable function privileges for a specific family for an access type. The following example creates read-only privileges for SSH for all the families except VLAN.

```
-> aaa switch-access priv-mask ssh read-only all-except vlan
```

If privileges for specific families need to be re-applied, then remove the existing privilege using the **no** command, and re-apply the required family privilege.

```
-> no aaa switch-access priv-mask telnet read-write all
-> aaa switch-access priv-mask telnet read-write vlan aaa
```

Configuring Management Station

Enable or disable the IP management station feature in a switch.

When the IP management station is disabled, the switch access from any IP address is allowed. After login failure, based on the lockout threshold value, (**ip-lockout threshold**) those IP address are banned/blocked and are added to the banned IP address list.

To disable the IP management station feature in a switch, use the disable option in the **aaa switch-access management-stations** command. By default, the IP management station feature state is disabled.

```
-> aaa switch-access management stations disable
```

When the management station is enabled, the switch access is allowed only from those IP addresses configured as management station IP, and only if they are not in the banned list.

To enable the IP management station feature in a switch, use the enable option in the **aaa switch-access management-stations** command.

```
-> aaa switch-access management stations enable
```

To configure the IP address for the management station, use the **aaa switch-access management-stations** command. A management station IP can be configured with or without mask value. The remote access is allowed only from these IP addresses. A maximum of 64 management stations can be configured.

```
-> aaa switch-access management stations 100.15.5.9
```

```
-> aaa switch-access management stations 100.15.5.9 mask 255.255.255.0
```

Verifying the ASA Configuration

To display information about management interfaces used for Authenticated Switch Access and ASA enhanced mode configuration, use the **show** commands listed here:

show aaa authentication	Displays information about the current authenticated switch session.
show aaa accounting mac	Displays information about accounting servers configured for Authenticated Switch Access or Authenticated VLANs.
aaa classification-rule mac-address	Displays information about a particular AAA server or AAA servers.
show aaa switch-access mode	Displays the global access mode configuration.
show aaa switch-access ip-lockout-threshold	Displays the lockout threshold configured for the remote IP addresses.
show aaa switch-access banned-ip	Displays the list of banned ip addresses.
show aaa switch-access priv-mask	Displays the privilege details for access types.
show aaa switch-access management-stations	Displays the list of configured management stations.

For more information about the resulting displays from these commands, see the *OmniSwitch AOS Release 6 CLI Reference Guide*. An example of the output for the **show aaa authentication** command is also given in “[Quick Steps for Setting Up ASA](#)” on page 10-7.

11 Using WebView

The switch can be monitored and configured using WebView, Alcatel-Lucent web-based device management tool. The WebView application is embedded in the switch and is accessible through the following web browsers:

- Internet Explorer 6 or later
- Firefox2 or later

Note. For information about setting up browser preferences and options, see [“Browser Setup” on page 11-2.](#)

In This Chapter

This chapter provides an overview of WebView and WebView functionality, and includes information about the following procedures:

- Configuring the Switch with WebView
 - WebView Login (see [page 11-8](#))
 - Home Page (see [page 11-9](#))
 - Configuration Page (see [page 11-12](#))
- Using WebView Help
 - Global Configuration Page (see [page 11-12](#))
 - Table Configuration Page (see [page 11-13](#))

Note. For detailed configuration information on each feature, see other chapters in this guide, the *OmniSwitch AOS Release 6 Network Configuration Guide*.

WebView CLI Defaults

Web Management Command Line Interface (CLI) commands allow you to enable/disable WebView, enable/disable Secure Socket Layer (SSL), and view basic WebView parameters. These configuration options are also available in WebView. The following table lists the defaults for WebView configuration through the **http** and **https** commands

Description	Command	Default
WebView Status	http server	enabled
Force SSL	http ssl	disabled
HTTPS port	https port	443
HTTP port	http port	80
WebView WLAN Cluster-Virtual-IP Precedence	webview wlan cluster-virtual-ip precedence	lldp

Browser Setup

Set up your browser preferences (or options) as follows:

- Cookies must be enabled. This is the default.
- JavaScript must be enabled/supported.
- Java must be enabled.
- Style sheets must be enabled; that is, the colors, fonts, backgrounds, and so on of web pages must always be used (rather than any user-configured settings).
- Checking for new versions of pages must be set to “Every time” when your browser opens.
- If you are using a proxy server, the proxy settings must be configured to bypass the switch on which you are running WebView (the local switch).

Typically many of these settings are configured as the default. Different browsers (and different versions of the same browser) can have different dialogs for these settings. Check your browser help pages if you need help.

WebView CLI Commands

The following configuration options can be performed using the CLI. These configuration options are also available in WebView; but changing the web server port or secured port can only be done through the CLI (or SNMP).

Enabling/Disabling WebView

WebView is enabled on the switch by default. If necessary, use the **http server** command to enable WebView. For example:

```
-> http server
```

Use the **no http server** command to disable WebView on the switch. If web management is disabled, you will not be able to access the switch using WebView. Use the **show http** command to view WebView status.

As an alternative you can use the **https** keyword instead of the **http** keyword to enable WebView. For example:

```
-> https server
```

When using this format of the command use the **no https server** command to disable WebView on the switch.

Changing the HTTP Port

The default HTTP port is 80, the well-known port number for Web servers. You can change the port to a number in the range 0 to 65535 using the **http port** command. (Well-known port numbers, which are in the range 0 to 1023, cannot be configured.)

Note. All WebView sessions must be terminated before the switch accepts the command.

For example:

```
-> http port 2000
```

This command changes the HTTP port to 2000.

To restore an HTTP port to its default value, use the **default** keyword as shown below:

```
-> http port default
```

Enabling/Disabling SSL

Force SSL is disabled by default. Use the **http ssl** command to enable Force SSL on the switch. For example:

```
-> http ssl
```

Use the **no http ssl** command to disable Force SSL on the switch. Use the **show http** command to view WebView status.

As an alternative you can use the **https** keyword instead of the **http** keyword to enable Force SSL. For example:

```
-> https ssl
```

When using this format of the command use the **no https server** command to disable Force SSL on the switch.

Changing the HTTPS Port

The default secure HTTP (HTTPS) port is 443, the well-known port number for SSL. You can change the port to a number in the range 0 to 65535 using the **https port** command. (Well-known port numbers, which are in the range 0 to 1023, cannot be configured.)

Note. All WebView sessions must be terminated before the switch accepts the command.

For example:

```
-> https port 2500
```

This command changes the secure HTTP port to 2500.

To restore an HTTPS port to its default value, use the **default** keyword as shown below:

```
-> https port default
```

Quick Steps for Setting Up WebView

- 1 Make sure you have an Ethernet connection to the switch.
- 2 Configure switch management for HTTP using the **aaa authentication** command. Enter the command, the port type that you are authenticating (**http**), and the name of the LDAP, RADIUS, ACE, or local server that is being used for authentication. For example, to configure switch management for HTTP using the “local” authentication server you would enter:

```
-> aaa authentication http local
```



- 3 Open a web browser.
- 4 Enter the IP address of the switch you want to access in the Address field of the browser and press Enter. The WebView login screen appears.
- 5 Enter the appropriate user ID and password (the initial user name is **admin** and the initial password is **switch**). After successful login, the Chassis Management Home Page appears.

WebView Overview

The following sections provide an overview of WebView page layouts. For information on configuring the switch with WebView, see [page 11-8](#).

WebView Page Layout

As shown below, each WebView page is divided into four areas:

- **Banner**—Used to access global options (e.g., global help, telnet, and log out). An icon is also displayed in this area to indicate the current directory (Certified or Working).
 - Certified** 
 - Working** 
- **Toolbar**—Used to access WebView features.
- **Feature Options**—Used to access specific configuration options for each feature (displayed in drop-down menus at the top of the page).
- **View/Configuration Area**—Used to view/configure a feature.

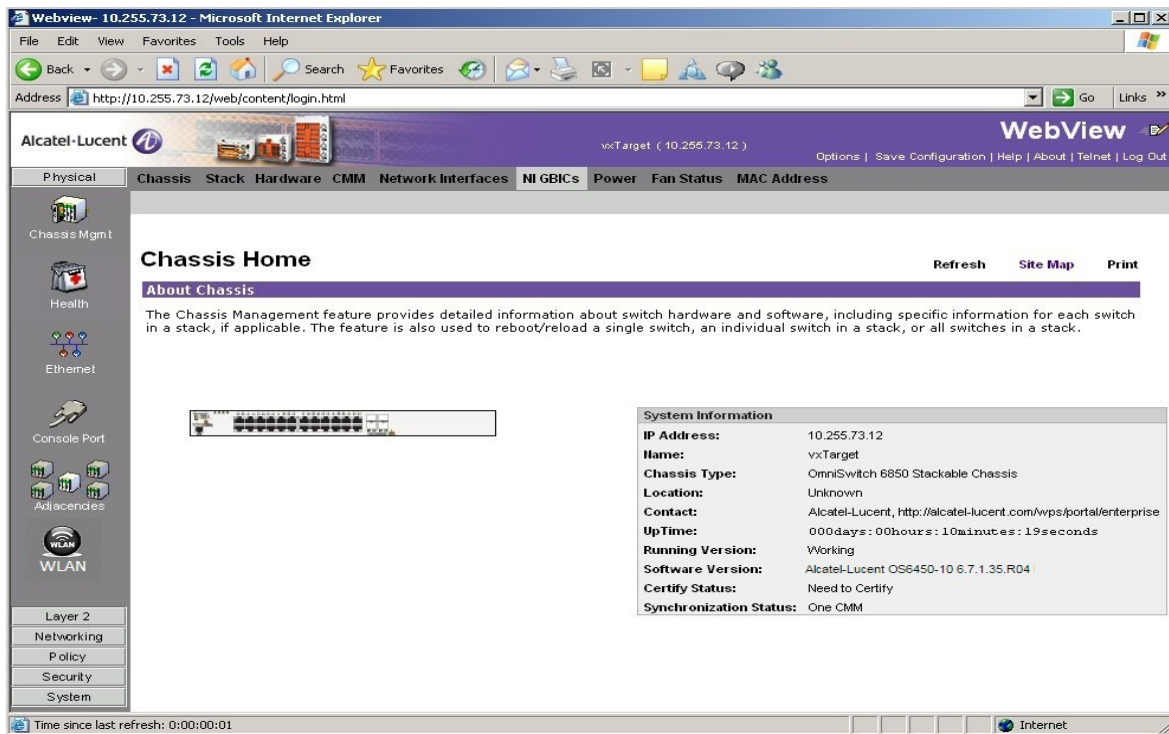

WebView Chassis Home Page

Banner

The following features are available in the WebView Banner:

- **Options**—Brings up the User Options Page, which is used to change the user login password.
- **Save Config**—Brings up the Save Configuration Screen. Click Apply to save the switch's running configuration for the next startup.
- **Help**—Brings up general WebView Help. Specific help pages are also available on each configuration page.
- **About**—Provides basic WebView product information.
- **Telnet**—Brings up a Telnet session window, through which you can access the switch for CLI configuration.
- **Log Out**—Logs the user out of the switch and ends the user session. After logout, the login screen appears. The user can log back into the switch or just close the login screen.

Toolbar

Switch configuration is divided into configuration groups in the toolbar (for example, Physical, Layer 2, and so on). Under each configuration group are switch features, identified by a name and an icon.

For detailed configuration information on each feature, see other chapters in this guide, the *OmniSwitch AOS Release 6 Network Configuration Guide*. Help pages are also available in WebView.

Feature Options

Feature configuration options are displayed as drop-down menus at the top of each feature page. For more information on using the drop-down menus, see [“Configuration Page” on page 11-12](#).

View/Configuration Area

The View/Configuration area is where switch configuration information is displayed and where configuration pages appear. After logging into WebView, a real-time graphical representation of the switch displays all of the switch’s current components. The feature configuration options on this page are used to configure the switch.

Configuring the Switch With WebView

The following sections provide an overview of WebView functionality. For detailed configuration procedures, see other chapters in this guide, the *OmniSwitch AOS Release 6 Network Configuration Guide*.

Accessing WebView

WebView is accessed using any of the browsers listed on [page 11-1](#). All of the necessary WebView files are stored on the switch. To access WebView and login to a switch:

- 1 Open a web browser.
- 2 Enter the IP address of the switch you want to configure in the browser Address field and press Enter. The login screen appears.

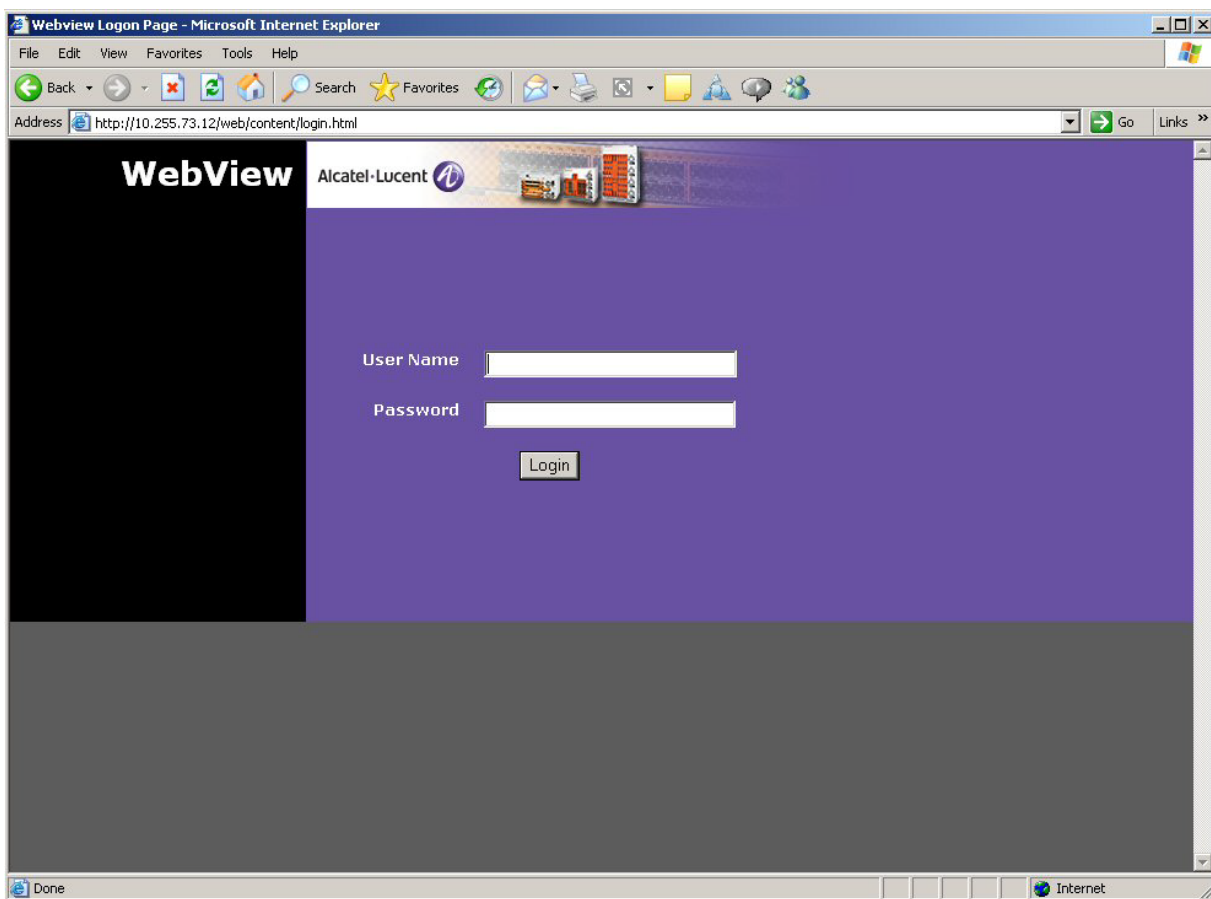

WebView Login Page

- 3 Enter the appropriate user ID and password at the login prompt (the initial user name is **admin** and the initial password is **switch**) and click Login. After successful login, the Chassis Management Home Page appears.

Note. You can access WebView through any NI on the switch.

To configure a feature in WebView, click on the feature icon in the toolbar on the left side of the screen. The first page displayed is the Home Page. Each configuration feature in WebView has a Home Page and a number of configuration pages. The Home Page provides an overview of the feature and its current configuration. The configuration pages are used to configure the feature.

Accessing WebView with Internet Explorer Version 7

When using Windows Internet Explorer Version 7 (IE7) browser software to access WebView with HTTPS, the following certificate warning message is displayed:

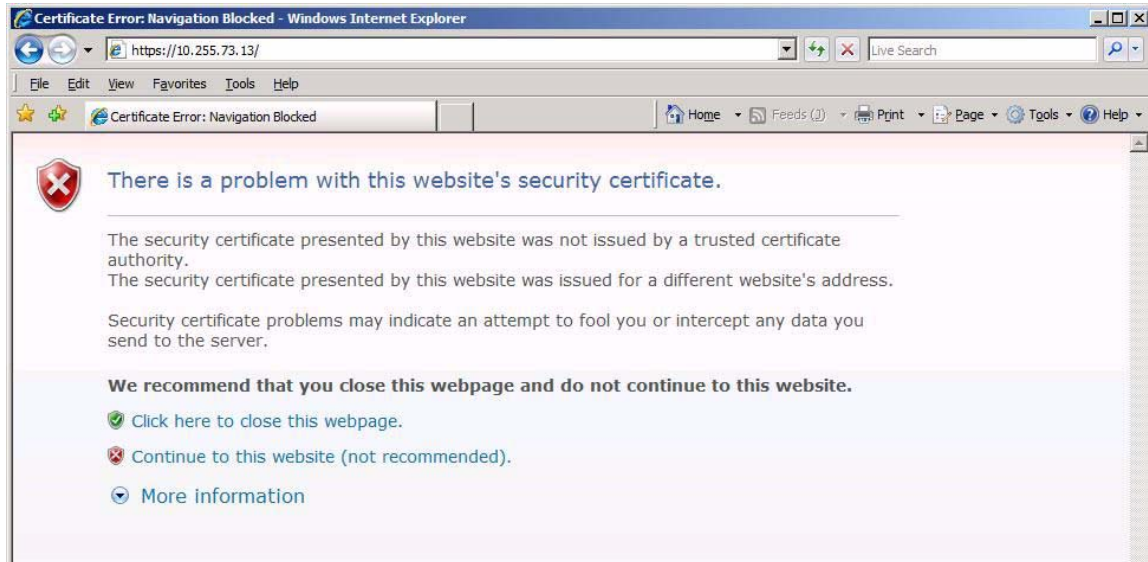

Click “Continue to this website (not recommended)” to continue the browser session. A certificate error message, similar to the one shown below, appears at the top of the WebView browser window.

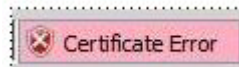

At this point, you can decide to do one of the following:

- Ignore the certificate error message and log into WebView. By doing so, the certificate error message always appears at the top of every WebView browser window; or,
 - Follow the steps below to install the Alcatel-Lucent self-signed certificate in the Trusted Root Certification Authorities store. This clears the certificate error message.
- 1 Click on the certificate error message. A “Certificate Invalid” popup window displays.

- 2 Click on “View Certificates” at the bottom of the “Certificate Invalid” popup window. A “Certificate Information” popup window displays.
- 3 Click on the “Install Certificate” button at the bottom of the “Certificate Information” window. This step launches the Certificate Import Wizard.
- 4 Click the “Next” button to continue with the Certificate Import Wizard process. The “Certificate Store” window displays.
- 5 Select “Place all certificates in the following store” and click on the “Browse” button. This displays a list of certificate stores.
- 6 Select “Trusted Root Certification Authorities” from the list of stores and continue with the wizard installation process. A “Security Warning” window is displayed containing a warning about installing the certificate.
- 7 Click the “Yes” button in the “Security Warning” window to finish installing the certificate. After the certificate is installed, the browser window no longer displays the certificate error message.

Home Page

The first page displayed for each feature is the Home Page (e.g., IP Home). The Home Page describes the feature and provides an overview of that feature’s current configuration. If applicable, home pages display the feature’s current configuration and can also be used to configure global parameters. Each Home Page also provides a Site Map (shown below), which displays all of the configuration options available for that feature. These are the same configuration options available in the drop-down menus at the top of the page.

Click to display feature Home Page.

Displays Site Map

Feature Overview

IP Home Page

Click on a configuration option to display the configuration page.

Click browser **Back** button to return to the Home Page.

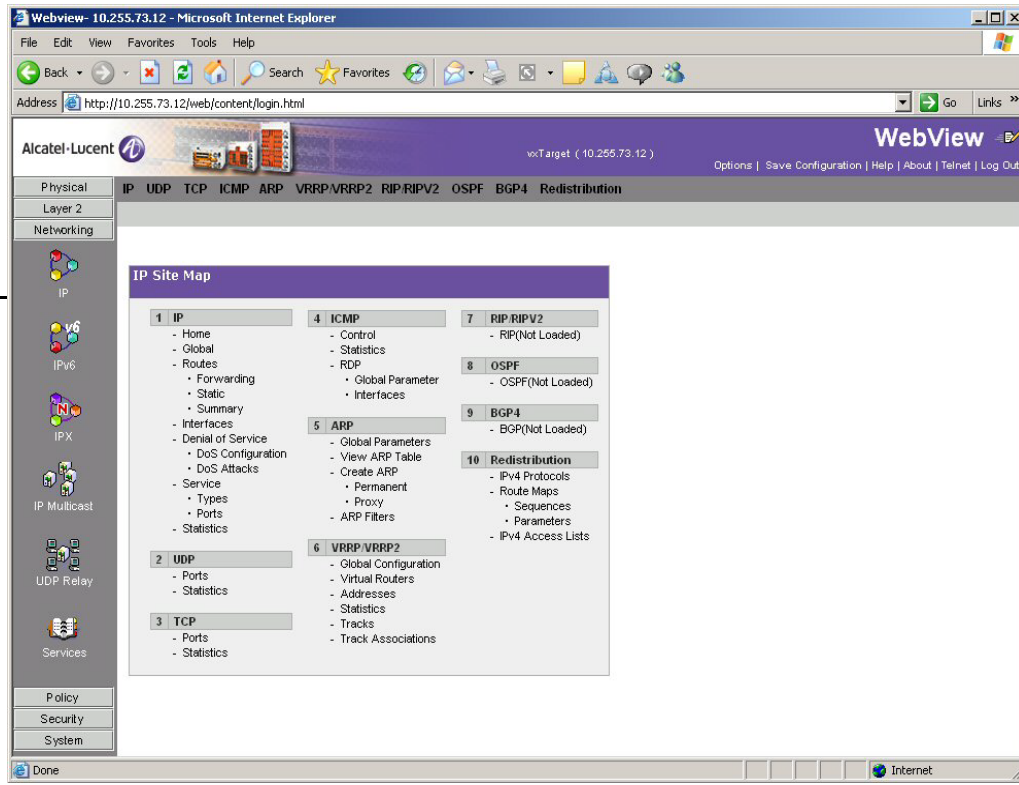

IP Site Map

Configuration Page

Feature configuration options are displayed in the drop-down menus at the top of each page. The same menus are displayed on every configuration page within a feature. To configure a feature on the switch, select a configuration option from the drop down menu. There are two types of configuration pages in WebView—a Global configuration page and a Table configuration page.

Global Configuration Page

Global configuration pages display drop-down menus and fields that you complete to configure global parameters. The fields display the current configuration. To change the configuration:

- 1 Select a new value from one of the drop-down lists or enter a new value in a field.
- 2 Click Apply to apply the changes to the switch. The new configuration takes effect immediately.
- 3 Repeat the procedure to make additional configuration changes.

Note. If you update a field and want to return it to the previous configuration, click Restore. However, you must click Restore before applying the new configuration. If you apply the new configuration and want to return to the previous configuration, you must re-enter the old configuration in the applicable fields.

The screenshot displays the 'Global IP Parameters' configuration page in the Alcatel-Lucent WebView interface. The page includes a navigation menu on the left with categories like Physical, Layer 2, Networking, IP, IPv6, IPX, IP Multicast, UDP Relay, Services, Policy, Security, and System. The main content area shows several configuration fields:

- Primary Router IP Address:** A text input field containing '10.255.73.12' with 'apply' and 'restore' buttons below it.
- Router ID:** A text input field containing '10.255.73.12' with 'apply' and 'restore' buttons below it.
- IP Directed Broadcast:** A dropdown menu set to 'Off' with 'apply' and 'restore' buttons below it.
- IP Route Preference:** A section containing:
 - Local:** A text input field containing '1' with 'apply' and 'restore' buttons below it.
 - Static:** A text input field containing '2' with 'apply' and 'restore' buttons below it.
 - OSPF:** A text input field containing '110' with 'apply' and 'restore' buttons below it.
 - RIP:** A text input field containing '120' with 'apply' and 'restore' buttons below it.

Annotations on the left side of the screenshot provide context for these elements:

- 'Enter a value.' points to the Primary Router IP Address field.
- 'Applies new configuration.' points to the 'apply' button.
- 'Select item from drop-down menu.' points to the IP Directed Broadcast dropdown menu.
- 'Restores original field values.' points to the 'restore' button.

Global Configuration Page

Table Configuration Page

Table configuration pages show current configurations in tabular form. Entries can be added, modified, or deleted. You can delete multiple entries, but you can only modify one entry at a time.

Click to select item to modify or delete.

<input type="checkbox"/>	VLAN	SVLAN	Description	Admin Status	Traffic Type	Operational Status	Flat STP Status	1x1 STP Status	Authentication	IP	VLAN Tag Mobile Port Status
<input type="checkbox"/>	1		VLAN 1	Enabled		Active	Enabled	Enabled	Disabled	Off	Disabled
<input type="checkbox"/>	73		VLAN 73	Enabled		Active	Enabled	Enabled	Disabled	On	Disabled

[Summary View]

Admin Status:
 Flat STP Status:
 1x1 STP Status:

Table Configuration Page

Adding a New Entry

To add a new entry to the table:

- 1 Click Add on the Configuration page. The Add window appears (e.g., Add IP Static Route).
- 2 Complete the fields, then click Apply. The new configuration takes effect immediately and the new entry appears in the table.
- 3 Repeat steps 1 and 2 to add additional entries.

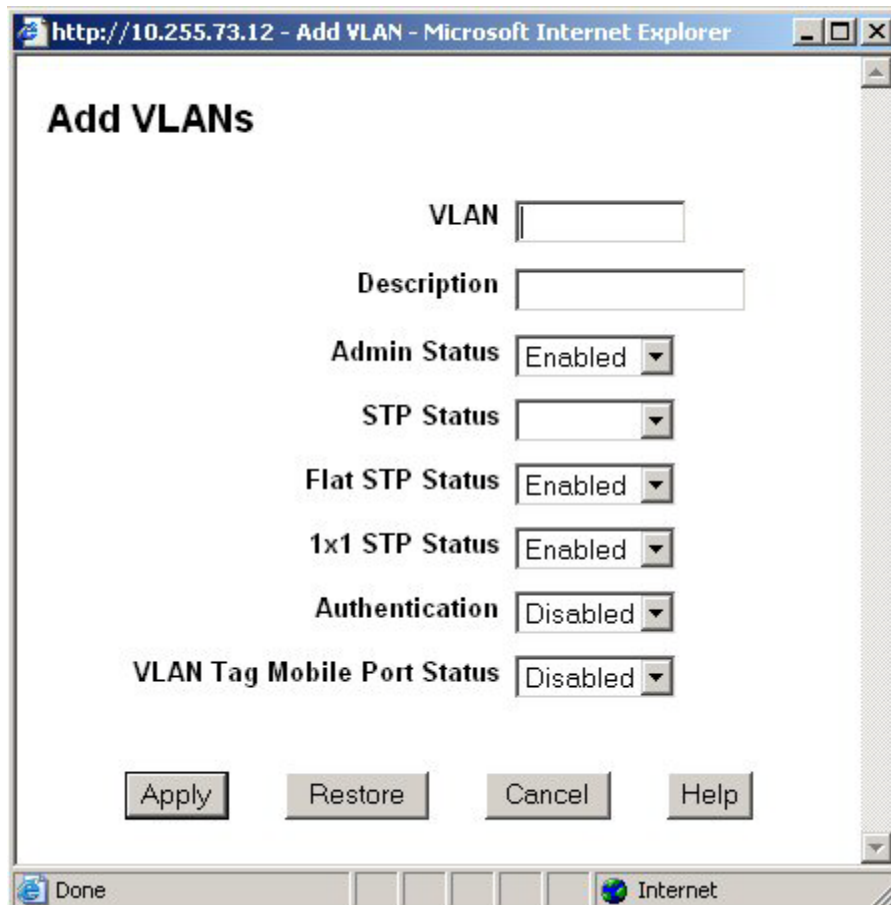

The screenshot shows a web browser window titled "http://10.255.73.12 - Add VLAN - Microsoft Internet Explorer". The main content area is titled "Add VLANs" and contains the following configuration fields:

- VLAN**: A text input field.
- Description**: A text input field.
- Admin Status**: A dropdown menu with "Enabled" selected.
- STP Status**: A dropdown menu.
- Flat STP Status**: A dropdown menu with "Enabled" selected.
- 1x1 STP Status**: A dropdown menu with "Enabled" selected.
- Authentication**: A dropdown menu with "Disabled" selected.
- VLAN Tag Mobile Port Status**: A dropdown menu with "Disabled" selected.

At the bottom of the form are four buttons: "Apply", "Restore", "Cancel", and "Help". The browser's status bar at the bottom shows "Done" and "Internet".

Add Window

Modifying an Existing Entry

To modify an existing entry:

- 1 Click on the checkbox to the left of the entry on the Configuration page and click Modify. The Modify window appears (e.g., Modify IP Static Route). The current configuration is displayed in each field.
- 2 Modify the applicable field(s), then click Apply. If successful, the Modify window disappears. The new configuration takes effect immediately and the modified entry appears in the table. If there is an error, the window remains and an error message is displayed.
- 3 Repeat the procedure to modify additional entries.

Modify VLAN

VLAN 73

Description

Admin Status

STP Status

Flat STP Status

1x1 STP Status

Authentication

VLAN Tag Mobile Port Status

Done Internet

Modify Window

Deleting an Existing Entry

To delete an existing entry:

- 1 Click on the checkbox to the left of the entry on the Configuration page.
- 2 Click Delete. The entry is immediately deleted from the table.

Note. You can delete multiple entries by selecting the checkbox next to each entry. Click on the top box to select all entries in the table.

Table Features

Table Views

Some table configuration pages can be expanded to view additional configuration information. If this option is available, a toggle switch appears at the bottom left corner of the table. To change views, click on the toggle switch (e.g., Expanded View). For example, if the table is in summary view, click on “Expanded View” to change to the expanded view. From the expanded view, click on “Summary View” to return to the summary view. For example:

The screenshot shows the Alcatel-Lucent WebView interface for VLAN Administration. The table is in an expanded view, showing the following data:

VLAN	SVLAN	Description	Admin Status	Operational Status	Flat STP Status	1x1 STP Status	Authentication	IP
1		VLAN 1	Enabled	Active	Enabled	Enabled	Disabled	Off
73		VLAN 73	Enabled	Active	Enabled	Enabled	Disabled	On

Below the table, there are controls for Admin Status, Flat STP Status, and 1x1 STP Status, each with a dropdown menu set to 'Enabled' and an 'Apply' button. There are also buttons for 'Add', 'Add SVLAN', 'Modify', 'Delete', 'Refresh', and 'Help'.

A text annotation "Click to expand the table." points to the bottom-left corner of the table.

Table View Feature—Summary View

Click to return to Summary view.

<input type="checkbox"/>	VLAN	SVLAN	Description	Admin Status	Traffic Type	Operational Status	Flat STP Status	1x1 STP Status	Authentication	IP	VLAN Tag Mobile Port Status	Priority
<input type="checkbox"/>	1		VLAN 1	Enabled		Active	Enabled	Enabled	Disabled	Off	Disabled	0
<input type="checkbox"/>	73		VLAN 73	Enabled		Active	Enabled	Enabled	Disabled	On	Disabled	0

[Summary View]

Admin Status: Apply
 Flat STP Status: Apply
 1x1 STP Status: Apply

Table View Feature—Expanded View

Table Sorting

Basic Sort

Table entries can be sorted by column in ascending or descending order. Initially, tables are sorted on the first column in ascending order (the number 1 appears in the first column). To sort in descending order, click on the column heading. Click again to return to the ascending order.

To sort on a different column, click on the column heading (the table sorts on that column and the number 1 appears at the top of the column). Click again to sort the data in descending order.

Note. You can also click on the “Flip” icon at the upper-right corner of the table to toggle between the ascending and the descending order.

Click to toggle between ascending and descending order.

<input type="checkbox"/>	VLAN	SVLAN	Description	Admin Status	Traffic Type	Operational Status	Flat STP Status	1x1 STP Status	Authentication	IP	VLAN Tag Mobile Port Status	Priority	Flip
<input type="checkbox"/>	1		VLAN 1	Enabled		Inactive	Enabled	Enabled	Disabled	Off	Disabled	0	
<input type="checkbox"/>	2		VLAN 2	Enabled		Inactive	Enabled	Enabled	Disabled	Off	Disabled	0	
<input type="checkbox"/>	3		VLAN 3	Enabled		Inactive	Enabled	Enabled	Disabled	Off	Disabled	0	
<input type="checkbox"/>	4		VLAN 4	Enabled		Inactive	Enabled	Enabled	Disabled	Off	Disabled	0	
<input type="checkbox"/>	5		VLAN 5	Enabled		Inactive	Enabled	Enabled	Disabled	Off	Disabled	0	
<input type="checkbox"/>	6		VLAN 6	Enabled		Inactive	Enabled	Enabled	Disabled	Off	Disabled	0	
<input type="checkbox"/>	7		VLAN 7	Enabled		Inactive	Enabled	Enabled	Disabled	Off	Disabled	0	
<input type="checkbox"/>	8		VLAN 8	Enabled		Inactive	Enabled	Enabled	Disabled	Off	Disabled	0	
<input type="checkbox"/>	9		VLAN 9	Enabled		Inactive	Enabled	Enabled	Disabled	Off	Disabled	0	
<input type="checkbox"/>	10		VLAN 10	Enabled		Inactive	Enabled	Enabled	Disabled	Off	Disabled	0	
<input type="checkbox"/>	11		VLAN 11	Enabled		Inactive	Enabled	Enabled	Disabled	Off	Disabled	0	
<input type="checkbox"/>	12		VLAN 12	Enabled		Inactive	Enabled	Enabled	Disabled	Off	Disabled	0	
<input type="checkbox"/>	13		VLAN 13	Enabled		Inactive	Enabled	Enabled	Disabled	Off	Disabled	0	
<input type="checkbox"/>	14		VLAN 14	Enabled		Inactive	Enabled	Enabled	Disabled	Off	Disabled	0	

"Flip" icon

Table Sort Feature—Initial Sort

Sort on a different column.

The screenshot shows the Alcatel-Lucent Webview interface for VLAN Administration. The table below lists various VLAN configurations. The 'Operational Status' column is currently selected for sorting, as indicated by the mouse cursor and the text annotation.

<input type="checkbox"/>	VLAN	SVLAN	Description	Admin Status	Traffic Type	Operational Status ▾	Flat STP Status	1x1 STP Status	Authentication	IP	VLAN Tag Mobile Port Status
<input type="checkbox"/>	73		VLAN 73	Enabled		Active	Enabled	Enabled	Disabled	On	Disabled
<input type="checkbox"/>	1		VLAN 1	Enabled		Active	Enabled	Enabled	Disabled	Off	Disabled
<input type="checkbox"/>	35		VLAN 35	Enabled		Inactive	Enabled	Enabled	Disabled	Off	Disabled
<input type="checkbox"/>	33		VLAN 33	Enabled		Inactive	Enabled	Enabled	Disabled	Off	Disabled
<input type="checkbox"/>	31		VLAN 31	Enabled		Inactive	Enabled	Enabled	Disabled	Off	Disabled
<input type="checkbox"/>	38		VLAN 38	Enabled		Inactive	Enabled	Enabled	Disabled	Off	Disabled
<input type="checkbox"/>	36		VLAN 36	Enabled		Inactive	Enabled	Enabled	Disabled	Off	Disabled
<input type="checkbox"/>	34		VLAN 34	Enabled		Inactive	Enabled	Enabled	Disabled	Off	Disabled
<input type="checkbox"/>	29		VLAN 29	Enabled		Inactive	Enabled	Enabled	Disabled	Off	Disabled
<input type="checkbox"/>	27		VLAN 27	Enabled		Inactive	Enabled	Enabled	Disabled	Off	Disabled
<input type="checkbox"/>	21		VLAN 21	Enabled		Inactive	Enabled	Enabled	Disabled	Off	Disabled
<input type="checkbox"/>	32		VLAN 32	Enabled		Inactive	Enabled	Enabled	Disabled	Off	Disabled
<input type="checkbox"/>	30		VLAN 30	Enabled		Inactive	Enabled	Enabled	Disabled	Off	Disabled

Table Sort Feature—Modified Sort

Advanced Sorting

You can also customize a sort by defining primary and secondary sort criteria. To define primary and secondary column sorts, click on the “Sort” icon in the upper-right corner of the table (the column headings are highlighted). Next, click on the primary and secondary column headings (the numbers 1 and 2 appear in the primary and secondary columns). Click again on the “Sort” icon to sort the table. Click on the “Clear” icon to clear the sort settings. You can sort up to four columns at one time.

Then, click on the primary and secondary column headings.

Click on the “Sort” icon.

<input type="checkbox"/>	VLAN	SVLAN	Description	Admin Status	Operational Status	Flat STP Status	1st STP Status	Authentication	IP
<input type="checkbox"/>	34		VLAN 34	Enabled	Inactive	Enabled	Enabled	Disabled	Off
<input type="checkbox"/>	35		VLAN 35	Enabled	Inactive	Enabled	Enabled	Disabled	Off
<input type="checkbox"/>	32		VLAN 32	Enabled	Inactive	Enabled	Enabled	Disabled	Off
<input type="checkbox"/>	33		VLAN 33	Enabled	Inactive	Enabled	Enabled	Disabled	Off
<input type="checkbox"/>	37		VLAN 37	Enabled	Inactive	Enabled	Enabled	Disabled	Off
<input type="checkbox"/>	38		VLAN 38	Enabled	Inactive	Enabled	Enabled	Disabled	Off
<input type="checkbox"/>	36		VLAN 36	Enabled	Inactive	Enabled	Enabled	Disabled	Off
<input type="checkbox"/>	27		VLAN 27	Enabled	Inactive	Enabled	Enabled	Disabled	Off
<input type="checkbox"/>	28		VLAN 28	Enabled	Inactive	Enabled	Enabled	Disabled	Off
<input type="checkbox"/>	26		VLAN 26	Enabled	Inactive	Enabled	Enabled	Disabled	Off
<input type="checkbox"/>	30		VLAN 30	Enabled	Inactive	Enabled	Enabled	Disabled	Off
<input type="checkbox"/>	31		VLAN 31	Enabled	Inactive	Enabled	Enabled	Disabled	Off
<input type="checkbox"/>	29		VLAN 29	Enabled	Inactive	Enabled	Enabled	Disabled	Off
<input type="checkbox"/>	47		VLAN 47	Enabled	Inactive	Enabled	Enabled	Disabled	Off
<input type="checkbox"/>	48		VLAN 48	Enabled	Inactive	Enabled	Enabled	Disabled	Off

Table Sort Feature—Advanced Sort

Table Paging

Certain potentially large tables (e.g., VLANs) have a paging feature that loads the table data in increments of 50 or 100 entries. If the table reaches this threshold, the first group of entries is displayed and a “Next” button appears at the bottom of the page. Click Next to view the next group of entries. Click Previous to view the previous group of entries.

The screenshot shows the Alcatel-Lucent WebView interface in a Microsoft Internet Explorer browser window. The browser address bar shows the URL `http://10.255.73.12/web/content/login.html`. The interface displays a navigation menu on the left with options like 'VLAN Mgmt', 'Spanning Tree', 'Link Aggregation', and 'Port Security'. The main content area shows a table of VLAN configurations under the 'VLAN Mgmt' tab. The table has columns for 'VLANs', 'IPX VLANs', 'Ports', and various status fields. The table displays entries for VLANs 92 through 100. Below the table, there is a 'Next' button with a right-pointing arrow. A text annotation with an arrow points to this button, stating: 'Click Next to view the next group of entries.' Below the table, there is also a note: 'Note: If the 'Prev.' or 'Next' arrow centered below the table is not visible, use the scrollbar.' At the bottom of the interface, there are several control buttons: 'Add', 'Add SVLAN', 'Admin Status' (set to 'Enabled'), 'Flat STP Status' (set to 'Enabled'), '1x1 STP Status' (set to 'Enabled'), 'Modify', 'Delete', and 'Refresh'.

VLANs	IPX VLANs	Ports									
<input type="checkbox"/>	92		VLAN 92	Enabled	Inactive	Enabled	Enabled	Disabled	Off	Disabled	
<input type="checkbox"/>	93		VLAN 93	Enabled	Inactive	Enabled	Enabled	Disabled	Off	Disabled	
<input type="checkbox"/>	94		VLAN 94	Enabled	Inactive	Enabled	Enabled	Disabled	Off	Disabled	
<input type="checkbox"/>	95		VLAN 95	Enabled	Inactive	Enabled	Enabled	Disabled	Off	Disabled	
<input type="checkbox"/>	96		VLAN 96	Enabled	Inactive	Enabled	Enabled	Disabled	Off	Disabled	
<input type="checkbox"/>	97		VLAN 97	Enabled	Inactive	Enabled	Enabled	Disabled	Off	Disabled	
<input type="checkbox"/>	98		VLAN 98	Enabled	Inactive	Enabled	Enabled	Disabled	Off	Disabled	
<input type="checkbox"/>	99		VLAN 99	Enabled	Inactive	Enabled	Enabled	Disabled	Off	Disabled	
<input type="checkbox"/>	100		VLAN 100	Enabled	Inactive	Enabled	Enabled	Disabled	Off	Disabled	

Table Paging Feature

Adjacencies

WebView provides a graphical representation of all AMAP-supported Alcatel-Lucent switches and IP phones adjacent to the switch. The following information for each device is also listed:

- IP address
- MAC address
- Remote slot/port

By clicking on a device, the Web-based device manager (if available) is displayed for that device. If a Web-based device manager is not available, a Telnet session can be launched. (A route to the adjacent switch must exist in the IP routing table for a Web-based device manager or Telnet session to be launched.)

To display the adjacencies, click on the Adjacencies button under the Physical group. The page displays similar to the following:

The screenshot shows the Alcatel-Lucent WebView interface in Microsoft Internet Explorer. The browser address bar shows `http://10.255.73.12/web/content/login.html`. The page title is "Adjacencies Home" and the breadcrumb is "Physical > Adjacencies > AMAP".

On the left sidebar, the "Adjacencies" button is highlighted. Annotations on the left indicate:

- "Mouse-over a switch to display switch information" points to a switch icon in the network diagram.
- "Click to display Adjacencies Page" points to the "Adjacencies" button in the sidebar.

The main content area shows "About Adjacencies" with the following text:

The switch is able to discover and advertise adjacent switch information using one of its Interswitch Protocols (AIP) called the Mapping Adjacency Protocol (AMAP). Below you will see all the AMAP supported switches adjacent to this switch. Right clicking an adjacent switch will show a list of IP addresses that the adjacent switch maintains and, if a route from this switch to the selected IP of the adjacent switch exists, may allow for WebView to be launched for subsequent configuration.

The network diagram shows a central switch connected to an adjacent switch. A tooltip over the adjacent switch displays the following information:

- Remote VLAN: 73
- Remote Ifc: 1/2
- MAC: 00:D0:95:9C:C6:E0

The status bar at the bottom indicates "Time since last refresh: 0:00:00:03" and "Internet" connectivity.

Adjacencies View

OAW-AP Web Management Configuration

The OAW-APs can be managed from the OAW-AP web interface. The OAW-AP web interface can be accessed from the WebView page by clicking on the **WLAN** button under the Physical group.

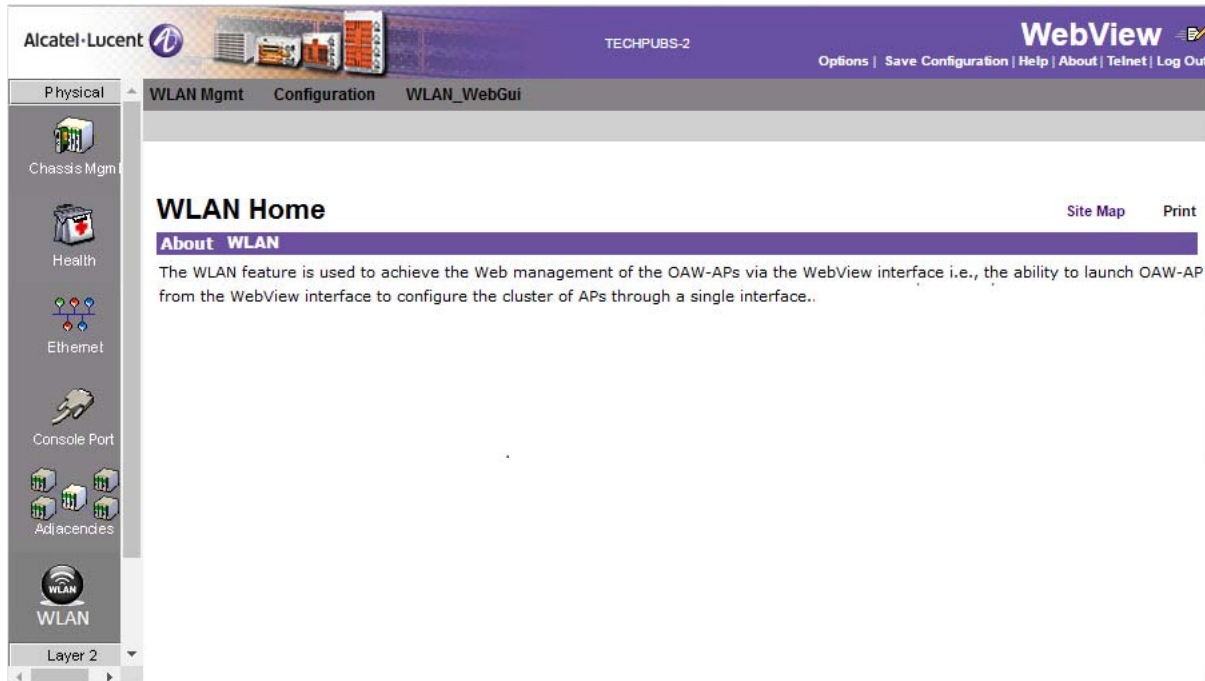

WLAN WebView Page

In order to access the OAW-AP web management interface, the switch must be aware of the Virtual Cluster IP of the AP. When you try to access the WLAN web management on the WebView page, the WebView server on the switch redirects the URL to the AP (Virtual IP Address) URL on port 8080 from where the OAW-APs can be managed. The Virtual Cluster IP address can be configured using the CLI on the OmniSwitch or from the WebView page.

Configuring the Virtual Cluster IP address for OAW-AP Web Management using CLI

To configure the AP Virtual Cluster IP address using the CLI, use the **webview wlan cluster-virtual-ip** CLI command. For example:

```
-> webview wlan cluster-virtual-ip 10.25.6.8
```

Automatic Configuration of Cluster Virtual IP Address

The Cluster Virtual IP address to access the group of APs through OmniSwitch Webview can be automatically configured. The OmniSwitch acquires the Cluster Virtual IP address from the LLDP TLV received from the Access Points (AP).

All AP belonging to the same L2 domain and having the same cluster-ID are grouped into a single cluster. Each of these APs have their own unique IP address and the cluster is associated with a single virtual IP address for management. The cluster can be configured or managed through a Web interface by connecting to the cluster virtual IP address. The cluster virtual IP address is associated with the primary AP of the

cluster. The OmniSwitch automatically configures the cluster virtual IP address from the received LLDP packets from the APs.

Enabling Automatic Configuration of Cluster Virtual IP Address

To automatically configure the cluster virtual IP address the precedence to obtain the cluster IP address from the LLDP packets must be set. To set the precedence for LLDP packets received from the APs, use the **webview wlan cluster-virtual-ip precedence** command. For example, the following command sets the precedence for LLDP packets:

```
-> webview wlan cluster-virtual-ip precedence lldp
```

Note. By default, the precedence is set for LLDP packets.

However, the precedence can be changed to the manually configured cluster virtual IP address. To set the precedence for manually configured virtual IP address, use the **webview wlan cluster-virtual-ip precedence** command. For example, the following command sets the precedence for manually configured IP address:

```
-> webview wlan cluster-virtual-ip precedence configured
```

The configuration can be verified using the **show webview wlan config** command.

For more information on the CLI, refer to *OmniSwitch AOS Release 6 CLI Reference Guide*.

Configuring the Virtual Cluster IP address for OAW-AP Web management using WebView

The Virtual Cluster IP address of the AP can be configured from the WebView page by clicking on the **WLAN** button under the Physical group. The WLAN WebView page is displayed.

Click on the **Configuration** tab to configure the Virtual Cluster IP address of the AP.

WLAN Virtual IP Configuration

Set the precedence to obtain the cluster virtual IP address from the **WLAN Cluster-Virtual-IP Precedence** drop down box. If LLDP is selected, then the precedence to obtain the cluster virtual IP address is set to LLDP packets coming from the APs. If Configured is selected, then the precedence to obtain the cluster virtual IP address is set to the manually configured IP address.

To manually configure the cluster virtual IP address, enter the cluster IP address in the **Configure WLAN Cluster IP address** box.

- 1 Click **Apply** to apply the changes. The Virtual Cluster IP address is configured.
- 2 Click **Restore** to restore the previous configuration.
- 3 Click **Refresh** to refresh the WLAN configuration page.

Note. By default, the precedence is set to LLDP.

Verifying the WLAN Configuration

The Virtual Cluster IP address configuration can be verified in the WLAN Configuration screen in the WebView or by using the **show webview wlan config** CLI on the OmniSwitch. For example:

```
-> show webview wlan config
WebView WLAN Cluster-Virtual-IP Precedence = LLDP
WebView WLAN Cluster-Virtual-IP configured address = 0.0.0.0
WebView WLAN Cluster-Virtual-IP LLDP address = 1.1.1.1
```

The output displays the precedence set for obtaining the cluster virtual IP address, the configured cluster virtual IP address, and the cluster virtual IP address obtained from the LLDP packets.

Accessing the WLAN Management page from WebView

To access the WLAN Management from WebView, click on the **WLAN_WebGui** tab in the WLAN WebView page. The WebView server on the switch redirects the URL to the configured OAW-AP (Virtual IP Address) URL on port 8080.

A separate page to access the WLAN Management page is displayed.

WebView Help

A general help page for using WebView is available from the banner at the top of the page. In addition, on-line help is available on every WebView page. Each help page provides a description of the page and specific instructions for each configurable field.

General WebView Help

To display general help for WebView, click the Help option in the WebView banner. (For information about the banner, see “WebView Page Layout” on page 11-5.)

The information in the help page is similar to the information given in this chapter.

Specific-page Help

Each help page provides a description of the page and a description for each field. To access help from any global configuration page, table page, or Add or Modify window:

- 1 Click the Help button at the bottom of the page. A help window displays similar to the following:

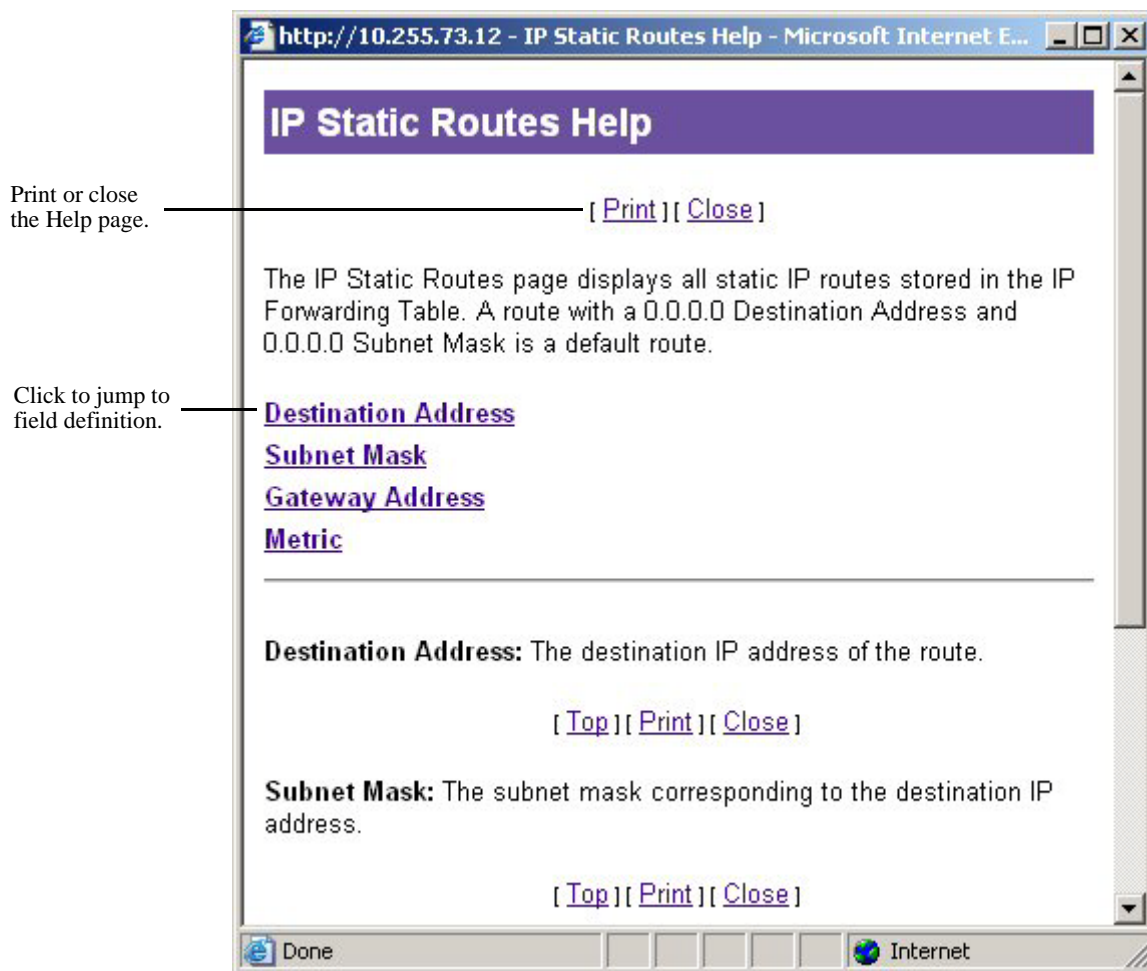

Help Page Layout

2 Click on the field name hyperlink on the Help page to go to the Help page for that field; or use the scroll bar on the right side of the Help page to scroll through help for all fields. (You can also click Print to print a hard copy of the Help page.)

Click Close or click the Close Window icon at the top-right corner to close the Help page and return to the configuration or table page.

A Software License and Copyright Statements

This appendix contains Alcatel-Lucent and third-party software vendor license and copyright statements.

Alcatel-Lucent License Agreement

ALE USA, Inc. SOFTWARE LICENSE AGREEMENT

IMPORTANT. Please read the terms and conditions of this license agreement carefully before opening this package.

By opening this package, you accept and agree to the terms of this license agreement. If you are not willing to be bound by the terms of this license agreement, do not open this package. Please promptly return the product and any materials in unopened form to the place where you obtained it for a full refund.

1. **License Grant.** This is a license, not a sales agreement, between you (the “Licensee”) and Alcatel-Lucent. Alcatel-Lucent hereby grants to Licensee, and Licensee accepts, a non-exclusive license to use program media and computer software contained therein (the “Licensed Files”) and the accompanying user documentation (collectively the “Licensed Materials”), only as authorized in this License Agreement. Licensee, subject to the terms of this License Agreement, may use one copy of the Licensed Files on the Licensee’s system. Licensee agrees not to assign, sublicense, transfer, pledge, lease, rent, or share their rights under this License Agreement. Licensee may retain the program media for backup purposes with retention of the copyright and other proprietary notices. Except as authorized under this paragraph, no copies of the Licensed Materials or any portions thereof may be made by Licensee and Licensee shall not modify, decompile, disassemble, reverse engineer, or otherwise attempt to derive the Source Code. Licensee is also advised that Alcatel-Lucent products contain embedded software known as firmware which resides in silicon. Licensee may not copy the firmware or transfer the firmware to another medium.

2. **ALE USA, Inc.’s Rights.** Licensee acknowledges and agrees that the Licensed Materials are the sole property of Alcatel-Lucent and its licensors (herein “its licensors”), protected by U.S. copyright law, trademark law, and are licensed on a right to use basis. Licensee further acknowledges and agrees that all rights, title, and interest in and to the Licensed Materials are and shall remain with Alcatel-Lucent and its licensors and that no such right, license, or interest shall be asserted with respect to such copyrights and trademarks. This License Agreement does not convey to Licensee an interest in or to the Licensed Materials, but only a limited right to use revocable in accordance with the terms of this License Agreement.

3. **Confidentiality.** Alcatel-Lucent considers the Licensed Files to contain valuable trade secrets of Alcatel-Lucent, the unauthorized disclosure of which could cause irreparable harm to Alcatel-Lucent. Except as expressly set forth herein, Licensee agrees to use reasonable efforts not to disclose the Licensed Files to any third party and not to use the Licensed Files other than for the purpose authorized by this License Agreement. This confidentiality obligation shall continue after any termination of this License Agreement.

4. **Indemnity.** Licensee agrees to indemnify, defend and hold Alcatel-Lucent harmless from any claim, lawsuit, legal proceeding, settlement or judgment (including without limitation Alcatel-Lucent's reasonable United States and local attorneys' and expert witnesses' fees and costs) arising out of or in connection with the unauthorized copying, marketing, performance or distribution of the Licensed Files.

5. **Limited Warranty.** Alcatel-Lucent warrants, for Licensee's benefit alone, that the program media shall, for a period of ninety (90) days from the date of commencement of this License Agreement (referred to as the Warranty Period), be free from defects in material and workmanship. Alcatel-Lucent further warrants, for Licensee benefit alone, that during the Warranty Period the Licensed Files shall operate substantially in accordance with the functional specifications in the User Guide. If during the Warranty Period, a defect in the Licensed Files appears, Licensee may return the Licensed Files to Alcatel-Lucent for either replacement or, if so elected by Alcatel-Lucent, refund of amounts paid by Licensee under this License Agreement. EXCEPT FOR THE WARRANTIES SET FORTH ABOVE, THE LICENSED MATERIALS ARE LICENSED "AS IS" AND ALE USA, Inc. AND ITS LICENSORS DISCLAIM ANY AND ALL OTHER WARRANTIES, WHETHER EXPRESS OR IMPLIED, INCLUDING (WITHOUT LIMITATION) ANY IMPLIED WARRANTIES OF MERCHANTABILITY OR FITNESS FOR A PARTICULAR PURPOSE. SOME STATES DO NOT ALLOW THE EXCLUSION OF IMPLIED WARRANTIES SO THE ABOVE EXCLUSIONS MAY NOT APPLY TO LICENSEE. THIS WARRANTY GIVES THE LICENSEE SPECIFIC LEGAL RIGHTS. LICENSEE MAY ALSO HAVE OTHER RIGHTS WHICH VARY FROM STATE TO STATE.

6. **Limitation of Liability.** Alcatel-Lucent's cumulative liability to Licensee or any other party for any loss or damages resulting from any claims, demands, or actions arising out of or relating to this License Agreement shall not exceed the license fee paid to Alcatel-Lucent for the Licensed Materials. IN NO EVENT SHALL ALE USA, Inc. BE LIABLE FOR ANY INDIRECT, INCIDENTAL, CONSEQUENTIAL, SPECIAL, OR EXEMPLARY DAMAGES OR LOST PROFITS, EVEN IF ALE USA, Inc. HAS BEEN ADVISED OF THE POSSIBILITY OF SUCH DAMAGES. SOME STATES DO NOT ALLOW THE LIMITATION OR EXCLUSION OF LIABILITY FOR INCIDENTAL OR CONSEQUENTIAL DAMAGES, SO THE ABOVE LIMITATION OR EXCLUSION TO INCIDENTAL OR CONSEQUENTIAL DAMAGES MAY NOT APPLY TO LICENSEE.

7. **Export Control.** This product is subject to the jurisdiction of the United States. Licensee may not export or reexport the Licensed Files, without complying with all United States export laws and regulations, including but not limited to (i) obtaining prior authorization from the U.S. Department of Commerce if a validated export license is required, and (ii) obtaining "written assurances" from licensees, if required.

8. **Support and Maintenance.** Except as may be provided in a separate agreement between Alcatel-Lucent and Licensee, if any, Alcatel-Lucent is under no obligation to maintain or support the copies of the Licensed Files made and distributed hereunder and Alcatel-Lucent has no obligation to furnish Licensee with any further assistance, documentation or information of any nature or kind.

9. **Term.** This License Agreement is effective upon Licensee opening this package and shall continue until terminated. Licensee may terminate this License Agreement at any time by returning the Licensed Materials and all copies thereof and extracts therefrom to Alcatel-Lucent and certifying to Alcatel-Lucent in writing that all Licensed Materials and all copies thereof and extracts therefrom have been returned or erased by the memory of Licensee's computer or made non-readable. Alcatel-Lucent may terminate this License Agreement upon the breach by Licensee of any term hereof. Upon such termination by

Alcatel-Lucent, Licensee agrees to return to ALE USA, Inc. ALE USA, Inc. or destroy the Licensed Materials and all copies and portions thereof.

10. Governing Law. This License Agreement shall be construed and governed in accordance with the laws of the State of California.

11. Severability. Should any term of this License Agreement be declared void or unenforceable by any court of competent jurisdiction, such declaration shall have no effect on the remaining terms herein.

12. No Waiver. The failure of either party to enforce any rights granted hereunder or to take action against the other party in the event of any breach hereunder shall not be deemed a waiver by that party as to subsequent enforcement of rights or subsequent actions in the event of future breaches.

13. Notes to United States Government Users. Software and documentation are provided with restricted rights. Use, duplication or disclosure by the government is subject to (i) restrictions set forth in GSA ADP Schedule Contract with ALE USA, Inc.'s reseller(s), or (ii) restrictions set forth in subparagraph (c) (1) and (2) of 48 CFR 52.227-19, as applicable.

14. Third Party Materials. Licensee is notified that the Licensed Files contain third party software and materials licensed to ALE USA, Inc. by certain third party licensors. Some third party licensors (e.g., Wind River and their licensors with respect to the Run-Time Module) are third party beneficiaries to this License Agreement with full rights of enforcement. Please refer to the section entitled "[Third Party Licenses and Notices](#)" on page A-4 for the third party license and notice terms.

Third Party Licenses and Notices

The licenses and notices related only to such third party software are set forth below:

A. Booting and Debugging Non-Proprietary Software

A small, separate software portion aggregated with the core software in this product and primarily used for initial booting and debugging constitutes non-proprietary software, some of which may be obtained in source code format from ALE USA, Inc. for a limited period of time. ALE USA, Inc. will provide a machine-readable copy of the applicable non-proprietary software to any requester for a cost of copying, shipping and handling. This offer will expire 3 years from the date of the first shipment of this product.

B. The OpenLDAP Public License: Version 2.8, 17 August 2003

Redistribution and use of this software and associated documentation (“Software”), with or without modification, are permitted provided that the following conditions are met:

- 1 Redistributions of source code must retain copyright statements and notices.
- 2 Redistributions in binary form must reproduce applicable copyright statements and notices, this list of conditions, and the following disclaimer in the documentation and/or other materials provided with the distribution.
- 3 Redistributions must contain a verbatim copy of this document.
- 4 The names and trademarks of the authors and copyright holders must not be used in advertising or otherwise to promote the sale, use or other dealing in this Software without specific, written prior permission.
- 5 Due credit should be given to the OpenLDAP Project.
- 6 The OpenLDAP Foundation may revise this license from time to time. Each revision is distinguished by a version number. You may use the Software under terms of this license revision or under the terms of any subsequent revision of the license.

THIS SOFTWARE IS PROVIDED BY THE OPENLDAP FOUNDATION AND CONTRIBUTORS “AS IS” AND ANY EXPRESSED OR IMPLIED WARRANTIES, INCLUDING, BUT NOT LIMITED TO, THE IMPLIED WARRANTIES OF MERCHANTABILITY AND FITNESS FOR A PARTICULAR PURPOSE ARE DISCLAIMED. IN NO EVENT SHALL THE OPENLDAP FOUNDATION OR ITS CONTRIBUTORS BE LIABLE FOR ANY DIRECT, INDIRECT, INCIDENTAL, SPECIAL, EXEMPLARY, OR CONSEQUENTIAL DAMAGES (INCLUDING, BUT NOT LIMITED TO, PROCUREMENT OF SUBSTITUTE GOODS OR SERVICES; LOSS OF USE, DATA, OR PROFITS; OR BUSINESS INTERRUPTION) HOWEVER CAUSED AND ON ANY THEORY OF LIABILITY, WHETHER IN CONTRACT, STRICT LIABILITY, OR TORT (INCLUDING NEGLIGENCE OR OTHERWISE) ARISING IN ANY WAY OUT OF THE USE OF THIS SOFTWARE, EVEN IF ADVISED OF THE POSSIBILITY OF SUCH DAMAGE.

OpenLDAP is a trademark of the OpenLDAP Foundation.

Copyright 1999-2000 The OpenLDAP Foundation, Redwood City, California, USA. All Rights Reserved. Permission to copy and distributed verbatim copies of this document is granted.

C. Linux

Linux is written and distributed under the GNU General Public License which means that its source code is freely-distributed and available to the general public.

D. GNU GENERAL PUBLIC LICENSE: Version 2, June 1991

Copyright (C) 1989, 1991 Free Software Foundation, Inc. 675 Mass Ave, Cambridge, MA 02139, USA
Everyone is permitted to copy and distribute verbatim copies of this license document, but changing it is not allowed.

Preamble

The licenses for most software are designed to take away your freedom to share and change it. By contrast, the GNU General Public License is intended to guarantee your freedom to share and change free software--to make sure the software is free for all its users. This General Public License applies to most of the Free Software Foundation's software and to any other program whose authors commit to using it. (Some other Free Software Foundation software is covered by the GNU Library General Public License instead.) You can apply it to your programs, too.

When we speak of free software, we are referring to freedom, not price. Our General Public Licenses are designed to make sure that you have the freedom to distribute copies of free software (and charge for this service if you wish), that you receive source code or can get it if you want it, that you can change the software or use pieces of it in new free programs; and that you know you can do these things.

To protect your rights, we need to make restrictions that forbid anyone to deny you these rights or to ask you to surrender the rights. These restrictions translate to certain responsibilities for you if you distribute copies of the software, or if you modify it.

For example, if you distribute copies of such a program, whether gratis or for a fee, you must give the recipients all the rights that you have. You must make sure that they, too, receive or can get the source code. And you must show them these terms so they know their rights.

We protect your rights with two steps: (1) copyright the software, and (2) offer you this license which gives you legal permission to copy, distribute and/or modify the software.

Also, for each author's protection and ours, we want to make certain that everyone understands that there is no warranty for this free software. If the software is modified by someone else and passed on, we want its recipients to know that what they have is not the original, so that any problems introduced by others will not reflect on the original authors' reputations.

Finally, any free program is threatened constantly by software patents. We wish to avoid the danger that redistributors of a free program will individually obtain patent licenses, in effect making the program proprietary. To prevent this, we have made it clear that any patent must be licensed for everyone's free use or not licensed at all.

The precise terms and conditions for copying, distribution and modification follow.

GNU GENERAL PUBLIC LICENSE TERMS AND CONDITIONS FOR COPYING, DISTRIBUTION AND MODIFICATION

0 This License applies to any program or other work which contains a notice placed by the copyright holder saying it may be distributed under the terms of this General Public License. The "Program", below, refers to any such program or work, and a "work based on the Program" means either the Program or any derivative work under copyright law: that is to say, a work containing the Program or a portion of it, either

verbatim or with modifications and/or translated into another language. (Hereinafter, translation is included without limitation in the term “modification”.) Each licensee is addressed as “you”.

Activities other than copying, distribution and modification are not covered by this License; they are outside its scope. The act of running the Program is not restricted, and the output from the Program is covered only if its contents constitute a work based on the Program (independent of having been made by running the Program). Whether that is true depends on what the Program does.

1 You may copy and distribute verbatim copies of the Program’s source code as you receive it, in any medium, provided that you conspicuously and appropriately publish on each copy an appropriate copyright notice and disclaimer of warranty; keep intact all the notices that refer to this License and to the absence of any warranty; and give any other recipients of the Program a copy of this License along with the Program.

You may charge a fee for the physical act of transferring a copy, and you may at your option offer warranty protection in exchange for a fee.

2 You may modify your copy or copies of the Program or any portion of it, thus forming a work based on the Program, and copy and distribute such modifications or work under the terms of Section 1 above, provided that you also meet all of these conditions:

- a** You must cause the modified files to carry prominent notices stating that you changed the files and the date of any change.
- b** You must cause any work that you distribute or publish, that in whole or in part contains or is derived from the Program or any part thereof, to be licensed as a whole at no charge to all third parties under the terms of this License.
- c** If the modified program normally reads commands interactively when run, you must cause it, when started running for such interactive use in the most ordinary way, to print or display an announcement including an appropriate copyright notice and a notice that there is no warranty (or else, saying that you provide a warranty) and that users may redistribute the program under these conditions, and telling the user how to view a copy of this License. (Exception: if the Program itself is interactive but does not normally print such an announcement, your work based on the Program is not required to print an announcement.)

These requirements apply to the modified work as a whole. If identifiable sections of that work are not derived from the Program, and can be reasonably considered independent and separate works in themselves, then this License, and its terms, do not apply to those sections when you distribute them as separate works. But when you distribute the same sections as part of a whole which is a work based on the Program, the distribution of the whole must be on the terms of this License, whose permissions for other licensees extend to the entire whole, and thus to each and every part regardless of who wrote it. Thus, it is not the intent of this section to claim rights or contest your rights to work written entirely by you; rather, the intent is to exercise the right to control the distribution of derivative or collective works based on the Program.

In addition, mere aggregation of another work not based on the Program with the Program (or with a work based on the Program) on a volume of a storage or distribution medium does not bring the other work under the scope of this License.

3 You may copy and distribute the Program (or a work based on it, under Section 2) in object code or executable form under the terms of Sections 1 and 2 above provided that you also do one of the following:

- a** Accompany it with the complete corresponding machine-readable source code, which must be distributed under the terms of Sections 1 and 2 above on a medium customarily used for software interchange; or,

b Accompany it with a written offer, valid for at least three years, to give any third party, for a charge no more than your cost of physically performing source distribution, a complete machine-readable copy of the corresponding source code, to be distributed under the terms of Sections 1 and 2 above on a medium customarily used for software interchange; or,

c Accompany it with the information you received as to the offer to distribute corresponding source code. (This alternative is allowed only for noncommercial distribution and only if you received the program in object code or executable form with such an offer, in accord with Subsection b above.)

The source code for a work means the preferred form of the work for making modifications to it. For an executable work, complete source code means all the source code for all modules it contains, plus any associated interface definition files, plus the scripts used to control compilation and installation of the executable. However, as a special exception, the source code distributed need not include anything that is normally distributed (in either source or binary form) with the major components (compiler, kernel, and so on) of the operating system on which the executable runs, unless that component itself accompanies the executable.

If distribution of executable or object code is made by offering access to copy from a designated place, then offering equivalent access to copy the source code from the same place counts as distribution of the source code, even though third parties are not compelled to copy the source along with the object code.

4 You may not copy, modify, sublicense, or distribute the Program except as expressly provided under this License. Any attempt otherwise to copy, modify, sublicense or distribute the Program is void, and will automatically terminate your rights under this License. However, parties who have received copies, or rights, from you under this License will not have their licenses terminated so long as such parties remain in full compliance.

5 You are not required to accept this License, since you have not signed it. However, nothing else grants you permission to modify or distribute the Program or its derivative works. These actions are prohibited by law if you do not accept this License. Therefore, by modifying or distributing the Program (or any work based on the Program), you indicate your acceptance of this License to do so, and all its terms and conditions for copying, distributing or modifying the Program or works based on it.

6 Each time you redistribute the Program (or any work based on the Program), the recipient automatically receives a license from the original licensor to copy, distribute or modify the Program subject to these terms and conditions. You may not impose any further restrictions on the recipients' exercise of the rights granted herein. You are not responsible for enforcing compliance by third parties to this License.

7 If, as a consequence of a court judgment or allegation of patent infringement or for any other reason (not limited to patent issues), conditions are imposed on you (whether by court order, agreement or otherwise) that contradict the conditions of this License, they do not excuse you from the conditions of this License. If you cannot distribute so as to satisfy simultaneously your obligations under this License and any other pertinent obligations, then as a consequence you may not distribute the Program at all. For example, if a patent license would not permit royalty-free redistribution of the Program by all those who receive copies directly or indirectly through you, then the only way you could satisfy both it and this License would be to refrain entirely from distribution of the Program.

If any portion of this section is held invalid or unenforceable under any particular circumstance, the balance of the section is intended to apply and the section as a whole is intended to apply in other circumstances.

It is not the purpose of this section to induce you to infringe any patents or other property right claims or to contest validity of any such claims; this section has the sole purpose of protecting the integrity of the free software distribution system, which is implemented by public license practices. Many people have made generous contributions to the wide range of software distributed through that system in reliance on

consistent application of that system; it is up to the author/donor to decide if he or she is willing to distribute software through any other system and a licensee cannot impose that choice.

This section is intended to make thoroughly clear what is believed to be a consequence of the rest of this License.

8 If the distribution and/or use of the Program is restricted in certain countries either by patents or by copyrighted interfaces, the original copyright holder who places the Program under this License may add an explicit geographical distribution limitation excluding those countries, so that distribution is permitted only in or among countries not thus excluded. In such case, this License incorporates the limitation as if written in the body of this License.

9 The Free Software Foundation may publish revised and/or new versions of the General Public License from time to time. Such new versions will be similar in spirit to the present version, but may differ in detail to address new problems or concerns.

Each version is given a distinguishing version number. If the Program specifies a version number of this License which applies to it and “any later version”, you have the option of following the terms and conditions either of that version or of any later version published by the Free Software Foundation. If the Program does not specify a version number of this License, you may choose any version ever published by the Free Software Foundation.

10 If you wish to incorporate parts of the Program into other free programs whose distribution conditions are different, write to the author to ask for permission. For software which is copyrighted by the Free Software Foundation, write to the Free Software Foundation; we sometimes make exceptions for this. Our decision will be guided by the two goals of preserving the free status of all derivatives of our free software and of promoting the sharing and reuse of software generally.

NO WARRANTY

11 BECAUSE THE PROGRAM IS LICENSED FREE OF CHARGE, THERE IS NO WARRANTY FOR THE PROGRAM, TO THE EXTENT PERMITTED BY APPLICABLE LAW. EXCEPT WHEN OTHERWISE STATED IN WRITING THE COPYRIGHT HOLDERS AND/OR OTHER PARTIES PROVIDE THE PROGRAM “AS IS” WITHOUT WARRANTY OF ANY KIND, EITHER EXPRESSED OR IMPLIED, INCLUDING, BUT NOT LIMITED TO, THE IMPLIED WARRANTIES OF MERCHANTABILITY AND FITNESS FOR A PARTICULAR PURPOSE. THE ENTIRE RISK AS TO THE QUALITY AND PERFORMANCE OF THE PROGRAM IS WITH YOU. SHOULD THE PROGRAM PROVE DEFECTIVE, YOU ASSUME THE COST OF ALL NECESSARY SERVICING, REPAIR OR CORRECTION.

12 IN NO EVENT UNLESS REQUIRED BY APPLICABLE LAW OR AGREED TO IN WRITING WILL ANY COPYRIGHT HOLDER, OR ANY OTHER PARTY WHO MAY MODIFY AND/OR REDISTRIBUTE THE PROGRAM AS PERMITTED ABOVE, BE LIABLE TO YOU FOR DAMAGES, INCLUDING ANY GENERAL, SPECIAL, INCIDENTAL OR CONSEQUENTIAL DAMAGES ARISING OUT OF THE USE OR INABILITY TO USE THE PROGRAM (INCLUDING BUT NOT LIMITED TO LOSS OF DATA OR DATA BEING RENDERED INACCURATE OR LOSSES SUSTAINED BY YOU OR THIRD PARTIES OR A FAILURE OF THE PROGRAM TO OPERATE WITH ANY OTHER PROGRAMS), EVEN IF SUCH HOLDER OR OTHER PARTY HAS BEEN ADVISED OF THE POSSIBILITY OF SUCH DAMAGES.

END OF TERMS AND CONDITIONS.

Appendix: How to Apply These Terms to Your New Programs

If you develop a new program, and you want it to be of the greatest possible use to the public, the best way to achieve this is to make it free software which everyone can redistribute and change under these terms.

To do so, attach the following notices to the program. It is safest to attach them to the start of each source file to most effectively convey the exclusion of warranty; and each file should have at least the “copyright” line and a pointer to where the full notice is found.

```
<one line to give the program's name and a brief idea of what it does.> Copyright (C)
19yy <name of author>
```

This program is free software; you can redistribute it and/or modify it under the terms of the GNU General Public License as published by the Free Software Foundation; either version 2 of the License, or (at your option) any later version.

This program is distributed in the hope that it will be useful, but WITHOUT ANY WARRANTY; without even the implied warranty of MERCHANTABILITY or FITNESS FOR A PARTICULAR PURPOSE. See the GNU General Public License for more details.

You should have received a copy of the GNU General Public License along with this program; if not, write to the Free Software Foundation, Inc., 675 Mass Ave, Cambridge, MA 02139, USA.

Also add information on how to contact you by electronic and paper mail.

If the program is interactive, make it output a short notice like this when it starts in an interactive mode:

```
Gnomovision version 69, Copyright (C) 19yy name of author Gnomovision comes with
ABSOLUTELY NO WARRANTY; for details type 'show w'. This is free software,
and you are welcome to redistribute it under certain conditions; type 'show c' for details.
```

The hypothetical commands ‘show w’ and ‘show c’ should show the appropriate parts of the General Public License. Of course, the commands you use may be called something other than ‘show w’ and ‘show c’; they could even be mouse-clicks or menu items--whatever suits your program.

You should also get your employer (if you work as a programmer) or your school, if any, to sign a “copyright disclaimer” for the program, if necessary. Here is a sample; alter the names:

```
Yoyodyne, Inc., hereby disclaims all copyright interest in the program 'Gnomovision'
(which makes passes at compilers) written by James Hacker.
```

```
<signature of Ty Coon>, 1 April 1989
Ty Coon, President of Vice
```

This General Public License does not permit incorporating your program into proprietary programs. If your program is a subroutine library, you may consider it more useful to permit linking proprietary applications with the library. If this is what you want to do, use the GNU Library General Public License instead of this License.

URLWatch:

For notice when this page changes, fill in your email address.

Maintained by: Webmaster, Linux Online Inc.

Last modified: 09-Aug-2000 02:03AM.

Views since 16-Aug-2000: 177203.

Material copyright Linux Online Inc.
Design and compilation copyright (c)1994-2002 Linux Online Inc.
Linux is a registered trademark of Linus Torvalds
Tux the Penguin, featured in our logo, was created by Larry Ewing
Consult our privacy statement

URLWatch provided by URLWatch Services.
All rights reserved.

E. University of California

Provided with this product is certain TCP input and Telnet client software developed by the University of California, Berkeley.

Copyright (C) 1987. The Regents of the University of California. All rights reserved.

Redistribution and use in source and binary forms are permitted provided that the above copyright notice and this paragraph are duplicated in all such forms and that any documentation, advertising materials, and other materials related to such distribution and use acknowledge that the software was developed by the University of California, Berkeley. The name of the University may not be used to endorse or promote products derived from this software without specific prior written permission.

THIS SOFTWARE IS PROVIDED ``AS IS" AND WITHOUT ANY EXPRESS OR IMPLIED WARRANTIES, INCLUDING, WITHOUT LIMITATION, THE IMPLIED WARRANTIES OF MERCHANTABILITY AND FITNESS FOR A PARTICULAR PURPOSE.

F. Carnegie-Mellon University

Provided with this product is certain BOOTP Relay software developed by Carnegie-Mellon University.

G. Random.c

PR 30872 B Kesner created May 5 2000

PR 30872 B Kesner June 16 2000 moved batch_entropy_process to own task iWhirlpool to make code more efficient

random.c -- A strong random number generator

Version 1.89, last modified 19-Sep-99

Copyright Theodore Ts'o, 1994, 1995, 1996, 1997, 1998, 1999. All rights reserved.

Redistribution and use in source and binary forms, with or without modification, are permitted provided that the following conditions are met:

1. Redistributions of source code must retain the above copyright notice, and the entire permission notice in its entirety, including the disclaimer of warranties.
2. Redistributions in binary form must reproduce the above copyright notice, this list of conditions and the following disclaimer in the documentation and/or other materials provided with the distribution.
3. The name of the author may not be used to endorse or promote products derived from this software without specific prior written permission. ALTERNATIVELY, this product may be distributed under the terms of the GNU Public License, in which case the provisions of the GPL are required INSTEAD OF the

above restrictions. (This clause is necessary due to a potential bad interaction between the GPL and the restrictions contained in a BSD-style copyright.)

THIS SOFTWARE IS PROVIDED “AS IS” AND ANY EXPRESS OR IMPLIED WARRANTIES, INCLUDING, BUT NOT LIMITED TO, THE IMPLIED WARRANTIES OF MERCHANTABILITY AND FITNESS FOR A PARTICULAR PURPOSE, ALL OF WHICH ARE HEREBY DISCLAIMED. IN NO EVENT SHALL THE AUTHOR BE LIABLE FOR ANY DIRECT, INDIRECT, INCIDENTAL, SPECIAL, EXEMPLARY, OR CONSEQUENTIAL DAMAGES (INCLUDING, BUT NOT LIMITED TO, PROCUREMENT OF SUBSTITUTE GOODS OR SERVICES; LOSS OF USE, DATA, OR PROFITS; OR BUSINESS INTERRUPTION) HOWEVER CAUSED AND ON ANY THEORY OF LIABILITY, WHETHER IN CONTRACT, STRICT LIABILITY, OR TORT (INCLUDING NEGLIGENCE OR OTHERWISE) ARISING IN ANY WAY OUT OF THE USE OF THIS SOFTWARE, EVEN IF NOT ADVISED OF THE POSSIBILITY OF SUCH DAMAGE.

H. Apptitude, Inc.

Provided with this product is certain network monitoring software (“MeterWorks/RMON”) licensed from Apptitude, Inc., whose copyright notice is as follows: Copyright (C) 1997-1999 by Apptitude, Inc. All Rights Reserved. Licensee is notified that Apptitude, Inc. (formerly, Technically Elite, Inc.), a California corporation with principal offices at 6330 San Ignacio Avenue, San Jose, California, is a third party beneficiary to the Software License Agreement. The provisions of the Software License Agreement as applied to MeterWorks/RMON are made expressly for the benefit of Apptitude, Inc., and are enforceable by Apptitude, Inc. in addition to ALE USA, Inc.. IN NO EVENT SHALL APPTITUDE, INC. OR ITS SUPPLIERS BE LIABLE FOR ANY DAMAGES, INCLUDING COSTS OF PROCUREMENT OF SUBSTITUTE PRODUCTS OR SERVICES, LOST PROFITS, OR ANY SPECIAL, INDIRECT, CONSEQUENTIAL OR INCIDENTAL DAMAGES, HOWEVER CAUSED AND ON ANY THEORY OF LIABILITY, ARISING IN ANY WAY OUT OF THIS AGREEMENT.

I. Agranat

Provided with this product is certain web server software (“EMWEB PRODUCT”) licensed from Agranat Systems, Inc. (“Agranat”). Agranat has granted to ALE USA, Inc. certain warranties of performance, which warranties [or portion thereof] ALE USA, Inc. now extends to Licensee. IN NO EVENT, HOWEVER, SHALL AGRANAT BE LIABLE TO LICENSEE FOR ANY INDIRECT, SPECIAL, OR CONSEQUENTIAL DAMAGES OF LICENSEE OR A THIRD PARTY AGAINST LICENSEE ARISING OUT OF, OR IN CONNECTION WITH, THIS DISTRIBUTION OF EMWEB PRODUCT TO LICENSEE. In case of any termination of the Software License Agreement between ALE USA, Inc. and Licensee, Licensee shall immediately return the EMWEB Product and any back-up copy to ALE USA, Inc., and will certify to ALE USA, Inc. in writing that all EMWEB Product components and any copies of the software have been returned or erased by the memory of Licensee’s computer or made non-readable.

J. RSA Security Inc.

Provided with this product is certain security software (“RSA Software”) licensed from RSA Security Inc. RSA SECURITY INC. PROVIDES RSA SOFTWARE “AS IS” WITHOUT ANY WARRANTY WHATSOEVER. RSA SECURITY INC. DISCLAIMS ALL WARRANTIES, EXPRESS, IMPLIED OR STATUTORY, AS TO ANY MATTER WHATSOEVER INCLUDING ALL IMPLIED WARRANTIES OF MERCHANTABILITY, FITNESS FOR A PARTICULAR PURPOSE AND NON-INFRINGEMENT OF THIRD PARTY RIGHTS.

K. Sun Microsystems, Inc.

This product contains Coronado ASIC, which includes a component derived from designs licensed from Sun Microsystems, Inc.

L. Wind River Systems, Inc.

Provided with this product is certain software (“Run-Time Module”) licensed from Wind River Systems, Inc. Licensee is prohibited from: (i) copying the Run-Time Module, except for archive purposes consistent with Licensee’s archive procedures; (ii) transferring the Run-Time Module to a third party apart from the product; (iii) modifying, decompiling, disassembling, reverse engineering or otherwise attempting to derive the source code of the Run-Time Module; (iv) exporting the Run-Time Module or underlying technology in contravention of applicable U.S. and foreign export laws and regulations; and (v) using the Run-Time Module other than in connection with operation of the product. In addition, please be advised that: (i) the Run-Time Module is licensed, not sold and that ALE USA, Inc. and its licensors retain ownership of all copies of the Run-Time Module; (ii) WIND RIVER DISCLAIMS ALL IMPLIED WARRANTIES, INCLUDING WITHOUT LIMITATION THE IMPLIED WARRANTIES OF MERCHANTABILITY, FITNESS FOR A PARTICULAR PURPOSE, (iii) The SOFTWARE LICENSE AGREEMENT EXCLUDES LIABILITY FOR ANY SPECIAL, INDIRECT, PUNITIVE, INCIDENTAL AND CONSEQUENTIAL DAMAGES; and (iv) any further distribution of the Run-Time Module shall be subject to the same restrictions set forth herein. With respect to the Run-Time Module, Wind River and its licensors are third party beneficiaries of the License Agreement and the provisions related to the Run-Time Module are made expressly for the benefit of, and are enforceable by, Wind River and its licensors.

M. Network Time Protocol Version 4

The following copyright notice applies to all files collectively called the Network Time Protocol Version 4 Distribution. Unless specifically declared otherwise in an individual file, this notice applies as if the text was explicitly included in the file.

```

*****
*
* Copyright (c) David L. Mills 1992-2003
*
* Permission to use, copy, modify, and distribute this software and
* its documentation for any purpose and without fee is hereby
* granted, provided that the above copyright notice appears in all
* copies and that both the copyright notice and this permission
* notice appear in supporting documentation, and that the name
* University of Delaware not be used in advertising or publicity
* pertaining to distribution of the software without specific,
* written prior permission. The University of Delaware makes no
* representations about the suitability this software for any
* purpose. It is provided "as is" without express or implied
* warranty.
*
*****

```

N.Remote-ni

Provided with this product is a file (part of GDB), the GNU debugger and is licensed from Free Software Foundation, Inc., whose copyright notice is as follows: Copyright (C) 1989, 1991, 1992 by Free Software Foundation, Inc. Licensee can redistribute this software and modify it under the terms of General Public License as published by Free Software Foundation Inc.

This program is distributed in the hope that it will be useful, but WITHOUT ANY WARRANTY; without even the implied warranty of MERCHANTABILITY or FITNESS FOR A PARTICULAR PURPOSE. See the GNU General Public License for more details.

O.GNU Zip

GNU Zip -- A compression utility which compresses the files with zip algorithm.

Copyright (C) 1992-1993 Jean-loup Gailly.

BECAUSE THE PROGRAM IS LICENSED FREE OF CHARGE, THERE IS NO WARRANTY FOR THE PROGRAM, TO THE EXTENT PERMITTED BY APPLICABLE LAW. EXCEPT WHEN OTHERWISE STATED IN WRITING THE COPYRIGHT HOLDERS AND/OR OTHER PARTIES PROVIDE THE PROGRAM "AS IS" WITHOUT WARRANTY OF ANY KIND, EITHER EXPRESSED OR IMPLIED, INCLUDING, BUT NOT LIMITED TO, THE IMPLIED WARRANTIES OF MERCHANTABILITY AND FITNESS FOR A PARTICULAR PURPOSE. THE ENTIRE RISK AS TO THE QUALITY AND PERFORMANCE OF THE PROGRAM IS WITH YOU. SHOULD THE PROGRAM PROVE DEFECTIVE, YOU ASSUME THE COST OF ALL NECESSARY SERVICING, REPAIR OR CORRECTION.

P. FREESCALE SEMICONDUCTOR SOFTWARE LICENSE AGREEMENT

Provided with this product is a software also known as DINK32 (Dynamic Interactive Nano Kernel for 32-bit processors) solely in conjunction with the development and marketing of your products which use and incorporate microprocessors which implement the PowerPC (TM) architecture manufactured by Motorola. The licensee comply with all of the following restrictions:

1. This entire notice is retained without alteration in any modified and/or redistributed versions.
2. The modified versions are clearly identified as such. No licenses are granted by implication, estoppel or otherwise under any patents or trademarks of Motorola, Inc.

The SOFTWARE is provided on an "AS IS" basis and without warranty. To the maximum extent permitted by applicable law, MOTOROLA DISCLAIMS ALL WARRANTIES WHETHER EXPRESS OR IMPLIED, INCLUDING IMPLIED WARRANTIES OF MERCHANTABILITY OR FITNESS FOR A PARTICULAR PURPOSE AND ANY WARRANTY AGAINST INFRINGEMENT WITH REGARD TO THE SOFTWARE (INCLUDING ANY MODIFIED VERSIONS THEREOF) AND ANY ACCOMPANYING WRITTEN MATERIALS. To the maximum extent permitted by applicable law, IN NO EVENT SHALL MOTOROLA BE LIABLE FOR ANY DAMAGES WHATSOEVER.

Copyright (C) Motorola, Inc. 1989-2001 All rights reserved.

Version 13.1

Q. Boost C++ Libraries

Provided with this product is free peer-reviewed portable C++ source libraries.

Version 1.33.1

Copyright (C) by Beman Dawes, David Abrahams, 1998-2003. All rights reserved.

THE SOFTWARE IS PROVIDED "AS IS", WITHOUT WARRANTY OF ANY KIND, EXPRESS OR IMPLIED, INCLUDING BUT NOT LIMITED TO THE WARRANTIES OF MERCHANTABILITY, FITNESS FOR A PARTICULAR PURPOSE, TITLE AND NON-INFRINGEMENT. IN NO EVENT SHALL THE COPYRIGHT HOLDERS OR ANYONE DISTRIBUTING THE SOFTWARE BE LIABLE FOR ANY DAMAGES OR OTHER LIABILITY, WHETHER IN CONTRACT, TORT OR OTHERWISE,

ARISING FROM, OUT OF OR IN CONNECTION WITH THE SOFTWARE OR THE USE OR OTHER DEALINGS IN THE SOFTWARE.

R. U-Boot

Provided with this product is a software licensed from Free Software Foundation Inc. This is used as OS Bootloader; and located in on-board flash. This product is standalone and not linked (statically or dynamically) to any other software.

Version 1.1.0

Copyright (C) 2000-2004. All rights reserved.

S. Solaris

Provided with this product is free software; Licensee can redistribute it and/or modify it under the terms of the GNU General Public License.

Copyright (C) 1992-1993 Jean-loup Gailly. All rights reserved.

T. Internet Protocol Version 6

Copyright (C) 1982, 1986, 1990, 1991, 1993. The Regents of the University of California. All rights reserved.

Redistribution and use in source and binary forms, with or without modification, are permitted provided that the following conditions are met:

1. Redistributions of source code must retain the above copyright notice, this list of conditions and the following disclaimer.
2. Redistributions in binary form must reproduce the above copyright notice, this list of conditions and the following disclaimer in the documentation and/or other materials provided with the distribution.
3. All advertising materials mentioning features or use of this software must display the following acknowledgment: This product includes software developed by the University of California, Berkeley and its contributors.

4. Neither the name of the University nor the names of its contributors may be used to endorse or promote products derived from this software without specific prior written permission.

THIS SOFTWARE IS PROVIDED BY THE REGENTS AND CONTRIBUTORS "AS IS" AND ANY EXPRESS OR IMPLIED WARRANTIES, INCLUDING, BUT NOT LIMITED TO, THE IMPLIED WARRANTIES OF MERCHANTABILITY AND FITNESS FOR A PARTICULAR PURPOSE ARE DISCLAIMED. IN NO EVENT SHALL THE REGENTS OR CONTRIBUTORS BE LIABLE FOR ANY DIRECT, INDIRECT, INCIDENTAL, SPECIAL, EXEMPLARY, OR CONSEQUENTIAL DAMAGES (INCLUDING, BUT NOT LIMITED TO, PROCUREMENT OF SUBSTITUTE GOODS OR SERVICES; LOSS OF USE, DATA, OR PROFITS; OR BUSINESS INTERRUPTION). HOWEVER CAUSED AND ON ANY THEORY OF LIABILITY, WHETHER IN CONTRACT, STRICT LIABILITY, OR TORT (INCLUDING NEGLIGENCE OR OTHERWISE) ARISING IN ANY WAY OUT OF THE USE OF THIS SOFTWARE, EVEN IF ADVISED OF THE POSSIBILITY OF SUCH DAMAGE.

The copyright of the products such as crypto, dhcp, net, netinet, netinet6, netley, netwrs, libinet6 are same as that of the internet protocol version 6.

U. CURSES

Copyright (C) 1987. The Regents of the University of California. All rights reserved.

Redistribution and use in source and binary forms are permitted provided that the above copyright notice and this paragraph are duplicated in all such forms and that any documentation, advertising materials, and other materials related to such distribution and use acknowledge that the software was developed by the University of California, Berkeley. The name of the University may not be used to endorse or promote products derived from this software without specific prior written permission.

V. ZModem

Provided with this product is a program or code that can be used without any restriction.

Copyright (C) 1986 Gary S. Brown. All rights reserved.

W.Boost Software License

Provided with this product is reference implementation, so that the Boost libraries are suitable for eventual standardization. Boost works on any modern operating system, including UNIX and Windows variants.

Version 1.0

Copyright (C) Gennadiy Rozental 2005. All rights reserved.

X. OpenLDAP

Provided with this software is an open source implementation of the Lightweight Directory Access Protocol (LDAP).

Version 3

Copyright (C) 1990, 1998, 1999, Regents of the University of Michigan, A. Hartgers, Juan C. Gomez. All rights reserved.

This software is not subject to any license of Eindhoven University of Technology. Redistribution and use in source and binary forms are permitted only as authorized by the OpenLDAP Public License.

This software is not subject to any license of Silicon Graphics Inc. or Purdue University. Redistribution and use in source and binary forms are permitted without restriction or fee of any kind as long as this notice is preserved.

Y. BITMAP.C

Provided with this product is a program for personal and non-profit use.

Copyright (C) Allen I. Holub, All rights reserved.

Z. University of Toronto

Provided with this product is a code that is modified specifically for use with the STEVIE editor. Permission is granted to anyone to use this software for any purpose on any computer system, and to redistribute it freely, subject to the following restrictions:

1. The author is not responsible for the consequences of use of this software, no matter how awful, even if they arise from defects in it.
2. The origin of this software must not be misrepresented, either by explicit claim or by omission.
3. Altered versions must be plainly marked as such, and must not be misrepresented as being the original software.

Version 1.5

Copyright (C) 1986 by University of Toronto and written by Henry Spencer.

AA.Free/OpenBSD

Copyright (c) 1982, 1986, 1990, 1991, 1993 The Regents of University of California. All Rights Reserved.

B SNMP Trap Information

This appendix lists the supported SNMP traps along with their descriptions.

SNMP Traps Table

The following table provides information on all SNMP traps supported by the switch. Each row includes the trap name, its ID number, any objects (if applicable), its command family, and a description of the condition the SNMP agent in the switch is reporting to the SNMP management station.

No.	Trap Name	Objects	Family	Description
0	coldStart	none	chassis	The SNMP agent in the switch is reinitiating and its configuration may have been altered.
1	warmStart	none	chassis	The SNMP agent in the switch is reinitiating itself and its configuration is unaltered.
2	linkDown	IfIndex ifAdminStatus ifOperStatus	interface	The SNMP agent in the switch recognizes a failure in one of the communications links configured for the switch.

IfIndex—A unique value, greater than zero, for each interface. It is recommended that values are assigned contiguously starting from 1. The value for each interface sub-layer must remain constant at least from one re-initialization of the entity's network management system to the next re-initialization.

ifAdminStatus—The desired state of the interface. The testing (3) state indicates that no operational packets can be passed. When a managed system initializes, all interfaces start with ifAdminStatus in the down (2) state. As a result of either explicit management action or per configuration information retained by the managed system, ifAdminStatus is then changed to either the up (1) or testing (3) states (or remains in the down (2) state).

ifOperStatus—The current operational state of the interface. The testing (3) state indicates that no operational packets can be passed. If ifAdminStatus is down (2) then ifOperStatus should be down(2). If ifAdminStatus is changed to up (1) then ifOperStatus should change to up (1) if the interface is ready to transmit and receive network traffic; it should change to dormant (5) if the interface is waiting for external actions (such as a serial line waiting for an incoming connection); it should remain in the down (2) state if and only if there is a fault that prevents it from going to the up (1) state; it should remain in the notPresent (6) state if the interface has missing (typically, hardware) components.

3	linkUp	ifIndex ifAdminStatus ifOperStatus	interface	The SNMP agent in the switch recognizes that one of the communications links configured for the switch has come up.
---	--------	--	-----------	---

IfIndex—A unique value, greater than zero, for each interface. It is recommended that values are assigned contiguously starting from 1. The value for each interface sub-layer must remain constant at least from one re-initialization of the entity's network management system to the next re-initialization.

ifAdminStatus—The desired state of the interface. The testing (3) state indicates that no operational packets can be passed. When a managed system initializes, all interfaces start with ifAdminStatus in the down (2) state. As a result of either explicit management action or per configuration information retained by the managed system, ifAdminStatus is then changed to either the up (1) or testing (3) states (or remains in the down (2) state).

ifOperStatus—The current operational state of the interface. The testing(3) state indicates that no operational packets can be passed. If ifAdminStatus is down (2) then ifOperStatus should be down (2). If ifAdminStatus is changed to up (1), then ifOperStatus should change to up (1) if the interface is ready to transmit and receive network traffic; it should change to dormant (5) if the interface is waiting for external actions (such as a serial line waiting for an incoming connection); it should remain in the down (2) state if and only if there is a fault that prevents it from going to the up (1) state; it should remain in the notPresent (6) state if the interface has missing (typically, hardware) components.

No.	Trap Name	Objects	Family	Description
4	authenticationFailure	none	snmp	The SNMP agent in the switch has received a protocol message that is not properly authenticated.
5	entConfigChange	none	module	An entConfigChange notification is generated when a conceptual row is created, modified, or deleted in one of the entity tables.
6	aipAMAPStatusTrap	aipAMAPLast-TrapReason aipAMAPLast-TrapPort	aip	The status of the Alcatel-Lucent Mapping Adjacency Protocol (AMAP) port changed.
<p>aipAMAPLastTrapReason—Reason for last change of port status. Valid reasons are 1 (port added), 2 (change of information on existing port), 3 (port deleted), and 4 (no trap has been sent).</p> <p>aipAMAPLastTrapPort—The ifindex number of the port that most recently changed.</p>				
7	aipGMAPConflictTrap	aipGMAPLast-TrapReason aipGMAPLast-TrapPort aipGMAPLast-TrapMac aipGMAPLast-TrapProtocol aipGMAPLast-TrapVlan	aip	Indicates a Group Mobility Advertisement Protocol (GMAP) port update conflict.
<p>aipGMAPLastTrapReason—Reason for last GMAP update to not be applied. Valid reasons are 1 (Target VLAN is an authenticated VLAN), 2 (update would conflict with a binding rule), 3 (update would create two different VLAN entries for the same protocol), 4 (update would create two different protocol entries for the same VLAN), 5 (target VLAN is not mobile), and 6 (no trap has been sent).</p> <p>aipGMAPLastTrapPort—The ifindex number of the last port on which the GMAP was not applied because of a conflict.</p> <p>aipGMAPLastTrapMac—The last MAC address for which a GMAP change was not applied because of a conflict.</p> <p>aipGMAPLastTrapProtocol—The protocol identifier of the last GMAP change that was not applied because of a conflict.</p> <p>aipGMAPLastTrapVlan—The VLAN identifier of the last GMAP change that was not applied because of a conflict.</p> <p>Note: This trap (GMAP) is not supported.</p>				
8	policyEventNotification	policyTrapEventDetail-String policyTrapEventCode	qos	The switch notifies the NMS when a significant event happens that involves the policy manager.
<p>policyTrapEventDetailString—Details about the event that took place.</p> <p>policyTrapEventCode—The code of the event.</p>				

No.	Trap Name	Objects	Family	Description
9	chassisTrapsStr	chassis- TrapsStrLevel chassis- TrapsStrApp- pID chassis- TrapsStrSnapI D chassisTrapsStr- fileName chassisTrapsStr- fileLineNb chassis- TrapsStrError Nb chassisTrapsStr- comments chassisTrapsStr- dataInfo	chassis	A software trouble report (STR) was sent by an application encountering a problem during its execution.

chassisTrapsStrLevel—An enumerated value that provides the urgency level of the STR.

chassisTrapsStrAppID—The application identification number.

chassisTrapsStrSnapID—The subapplication identification number. You can have multiple snapIDs per Subapplication (task) but only one is to be used to send STRs.

chassisTrapsStrfileName—Name of the source file where the fault was detected. This is given by the C ANSI macro `__FILE__`. The path shouldn't appear.

chassisTrapsStrfileLineNb—Line number in the source file where the fault was detected. This is given by the C ANSI macro `__LINE__`.

chassisTrapsStrErrorNb—The fault identifier. The error number identifies the kind the detected fault and allows a mapping of the data contained in chassisTrapsdataInfo.

chassisTrapsStrcomments—Comment text explaining the fault.

chassisTrapsStrdataInfo—Additional data provided to help to find out the origin of the fault. The contained and the significant portion are varying in accordance with chassisTrapsStrErrorNb. The length of this field is expressed in bytes.

10	chassisTrapsAlert	physicalIndex chassisTrapsOb- jectType chassisTrapsOb- jectNumber chassisTrap- sAlertNumber chassisTrap- sAlertDescr	chassis	A notification that some change has occurred in the chassis.
----	-------------------	--	---------	--

physicalIndex—The physical index of the involved object.

chassisTrapsObjectType—An enumerated value that provides the object type involved in the alert trap.

chassisTrapsObjectNumber—A number defining the order of the object in the set (e.g., the number of the considered fan or power supply). This is intended to clarify as much as possible the location of the failure or alert. An instance of the appearance of the trap could be “failure on a module. Power supply 3”.

chassisTrapsAlertNumber—This number that identifies the alert among all the possible chassis alert causes.

chassisTrapsAlertDescr—The description of the alert matching ChassisTrapsAlertNumber.

No.	Trap Name	Objects	Family	Description
11	chassisTrapsStateChange	physicalIndex chassisTrapsObject Type chassisTrapsObject Number chasEntPhysOper Status	chassis	An NI status change was detected.
<p>physicalIndex—The physical index of the involved object. chassisTrapsObjectType—An enumerated value that provides the object type involved in the alert trap. chassisTrapsObjectNumber—A number defining the order of the object in the set (e.g., the number of the considered fan or power supply). This intends to clarify as much as possible the location of the failure or alert. An instance of the appearance of the trap could be “failure on a module. Power supply 3”. chasEntPhysOperStatus—An enumerated value that indicates the operational status of installed modules (includes empty slots).</p>				
12	chassisTrapsMacOverlap	physicalIndex chasTrapMacRange Index	module	A MAC range overlap was found in the backplane eeprom.
<p>physicalIndex—The physical index of the involved object. chasTrapMacRangeIndex—The MAC range index of the involved object.</p>				
15	healthMonDeviceTrap	healthMonRx- Status healthMonRxTx- Status healthMonMem- oryStatus healthMonCpuS- tatus healthMonCm- mTempStatus healthMonCm- mCpuTemp- Status	health	Indicates a device-level threshold was crossed.
<p>healthMonRxStatus—Rx threshold status indicating if threshold was crossed or no change. healthMonRxTxStatus— RxTx threshold status indicating if threshold was crossed or no change. healthMonMemoryStatus—Memory threshold status indicating if threshold was crossed or no change. healthMonCpuStatus—CPU threshold status indicating if threshold was crossed or no change. healthMonCmmTempStatus—CMM temperature threshold status indicating if threshold was crossed or no change. healthMonCmmCpuTempStatus—CMM CPU temperature threshold status indicating if threshold was crossed or no change.</p>				

No.	Trap Name	Objects	Family	Description
16	healthMonModuleTrap	healthModuleSlot healthMonRxStatus healthMonRxDxStatus healthMonMemoryStatus healthMonCpuStatus	health	Indicates a module-level threshold was crossed.
<p>healthModuleSlot—The (one-based) front slot number within the chassis.</p> <p>healthMonRxStatus—Rx threshold status indicating if threshold was crossed or no change.</p> <p>healthMonRxDxStatus—RxTx threshold status indicating if threshold was crossed or no change.</p> <p>healthMonMemoryStatus—Memory threshold status indicating if threshold was crossed or no change.</p> <p>healthMonCpuStatus—CPU threshold status indicating if threshold was crossed or no change.</p>				
17	healthMonPortTrap	healthPortSlot healthPortIF healthMonRxStatus healthMonRxDxStatus	health	Indicates a port-level threshold was crossed.
<p>healthPortSlot—The physical slot number for this port.</p> <p>healthPortIF—The on-board interface number.</p> <p>healthMonRxStatus—Rx threshold status indicating if threshold was crossed or no change.</p> <p>healthMonRxDxStatus—RxTx threshold status indicating if threshold was crossed or no change.</p>				
20	esmDrvTrapDropsLink	esmPortSlot esmPortIF ifInErrors ifOutErrors esmDrvTrapDrops	interface	This trap is sent when the Ethernet code drops the link because of excessive errors.
<p>esmPortSlot—The physical slot number for this Ethernet Port. The slot number has been added to be used by the private trap.</p> <p>esmPortIF—The on-board interface number for this Ethernet port. The port number has been added to be used by the private trap.</p> <p>ifInErrors—For packet-oriented interfaces, the number of inbound packets that contained errors preventing them from being deliverable to a higher-layer protocol. For character-oriented or fixed-length interfaces, the number of inbound transmission units that contained errors preventing them from being deliverable to a higher-layer protocol. Discontinuities in the value of this counter can occur at re-initialization of the management system and at other times as indicated by the value of ifCounterDiscontinuityTime.</p> <p>ifOutErrors—For packet-oriented interfaces, the number of outbound packets that could not be transmitted because of errors. For character-oriented or fixed-length interfaces, the number of outbound transmission units that could not be transmitted because of errors. Discontinuities in the value of this counter can occur at re-initialization of the management system and at other times as indicated by the value of ifCounterDiscontinuityTime.</p> <p>esmDrvTrapDrops— Partitioned port (separated due to errors).</p>				

No.	Trap Name	Objects	Family	Description
21	pimNeighborLoss	pimNeighborIfIndex	ipmr	Signifies the loss of adjacency with a neighbor device. This trap is generated when the neighbor time expires and the switch has no other neighbors on the same interface with a lower IP address than itself.
pimNeighborIfIndex —The value of ifIndex for the interface used to reach this PIM neighbor.				
24	risingAlarm	alarmIndex alarmVariable alarmSampleType alarmValue alarmRisingThreshold	rmon	An Ethernet statistical variable has exceeded its rising threshold. The variable's rising threshold and whether it will issue an SNMP trap for this condition are configured by an NMS station running RMON.
alarmIndex —An index that uniquely identifies an entry in the alarm table. Each such entry defines a diagnostic sample at a particular interval for an object on the device.				
alarmVariable —The object identifier of the particular variable to be sampled. Only variables that resolve to an ASN.1 primitive type of INTEGER (INTEGER, Integer32, Counter32, Counter64, Gauge, or TimeTicks) may be sampled.				
alarmSampleType —The method of sampling the selected variable and calculating the value to be compared against the thresholds. If the value of this object is absoluteValue (1), the value of the selected variable will be compared directly with the thresholds at the end of the sampling interval. If the value of this object is deltaValue (2), the value of the selected variable at the last sample will be subtracted from the current value, and the difference compared with the thresholds.				
alarmValue —The value of the statistic during the last sampling period. For example, if the sample type is deltaValue, this value will be the difference between the samples at the beginning and end of the period. If the sample type is absoluteValue, this value will be the sampled value at the end of the period.				
alarmRisingThreshold —A threshold for the sampled statistic. When the current sampled value is greater than or equal to this threshold, and the value at the last sampling interval was less than this threshold, a single event will be generated. A single event will also be generated if the first sample after this entry becomes valid is greater than or equal to this threshold and the associated alarmStartupAlarm is equal to risingAlarm (1) or risingOrFallingAlarm (3).				

No.	Trap Name	Objects	Family	Description
25	fallingAlarm	alarmIndex alarmVariable alarmSample- Type alarmValue alarmFalling- Threshold	rmon	An Ethernet statistical variable has dipped below its falling threshold. The variable's falling threshold and whether it will issue an SNMP trap for this condition are configured by an NMS station running RMON.
<p>alarmIndex—An index that uniquely identifies an entry in the alarm table. Each such entry defines a diagnostic sample at a particular interval for an object on the device.</p> <p>alarmVariable—The object identifier of the particular variable to be sampled. Only variables that resolve to an ASN.1 primitive type of INTEGER (INTEGER, Integer32, Counter32, Counter64, Gauge, or TimeTicks) may be sampled.</p> <p>alarmSampleType—The method of sampling the selected variable and calculating the value to be compared against the thresholds. If the value of this object is absoluteValue (1), the value of the selected variable will be compared directly with the thresholds at the end of the sampling interval. If the value of this object is deltaValue (2), the value of the selected variable at the last sample will be subtracted from the current value, and the difference compared with the thresholds.</p> <p>alarmValue—The value of the statistic during the last sampling period. For example, if the sample type is deltaValue, this value will be the difference between the samples at the beginning and end of the period. If the sample type is absoluteValue, this value will be the sampled value at the end of the period.</p> <p>alarmFallingThreshold—A threshold for the sampled statistic. When the current sampled value is less than or equal to this threshold, and the value at the last sampling interval was greater than this threshold, a single event will be generated. A single event will also be generated if the first sample after this entry becomes valid is less than or equal to this threshold and the associated alarmStartupAlarm is equal to fallingAlarm (2) or risingOrFallingAlarm (3).</p>				
26	stpNewRoot	vStpNumber	stp	Sent by a bridge that became the new root of the spanning tree.
<p>vStpNumber—The Spanning Tree number identifying this instance.</p>				
27	stpRootPortChange	vStpNumber vStpRootPort- Number	stp	A root port has changed for a spanning tree bridge. The root port is the port that offers the lowest cost path from this bridge to the root bridge.
<p>vStpNumber—The Spanning Tree number identifying this instance.</p> <p>vStpRootPortNumber—The port ifindex of the port which offers the lowest cost path from this bridge to the root bridge for this spanning tree instance.</p>				
28	mirrorConfigError	mirmonPrimarySlot mirmonPrimary- Port mirroringSlot mirroringPort mirMonErrorNi mirMonError	pmm	The mirroring configuration failed on an NI. This trap is sent when any NI fails to configure mirroring. Due to this error, port mirroring session will be terminated.
<p>mirmonPrimarySlot—Slot of mirrored or monitored interface.</p> <p>mirmonPrimaryPort—Port of mirrored or monitored interface.</p> <p>mirroringSlot—Slot of mirroring interface.</p> <p>mirroringPort—Port of mirroring interface.</p> <p>mirMonErrorNi—The NI slot number.</p> <p>mirMonError—The Error returned by the NI which failed to configure Mirroring/Monitoring.</p>				

No.	Trap Name	Objects	Family	Description
29	mirrorUnlikeNi	mirmonPrimarySlot mirmonPrimaryPort mirroringSlot mirroringPort mirMonErrorNi	pmm	The mirroring configuration is deleted due to the swapping of different NI board type. The Port Mirroring session which was active on a slot cannot continue with the insertion of different NI type in the same slot.
<p>mirmonPrimarySlot—Slot of mirrored or monitored interface. mirmonPrimaryPort—Port of mirrored or monitored interface. mirroringSlot—Slot of mirroring interface. mirroringPort—Port of mirroring interface. mirMonErrorNi—The NI slot number. mirMonError—The Error returned by the NI which failed to configure Mirroring/Monitoring.</p>				
30	sIPCAMStatusTrap	sIPCAMSlotNumber sIPCAMSliceNumber sIPCAMStatus	bridge	The trap status of the Layer 2 pseudoCAM for this NI.
<p>sIPCAMSlotNumber—The slot number of this Coronado switching/routing ASIC. sIPCAMSliceNumber—The slice number of this Coronado switching/routing ASIC. sIPCAMStatus—The Layer 2 pseudoCAM status of this Coronado switching/routing ASIC.</p>				
31	unused	N/A	N/A	
32	unused	N/A	N/A	
34	ifMauJabberTrap	ifMauJabberState	interface	This trap is sent whenever a managed interface MAU enters the jabber state.
<p>ifMauJabberState—The value other(1) is returned if the jabber state is not 2, 3, or 4. The agent MUST always return other(1) for MAU type dot3MauTypeAUI. The value unknown(2) is returned when the MAU's true state is unknown; for example, when it is being initialized. If the MAU is not jabbering the agent returns noJabber(3). This is the "normal" state. If the MAU is in jabber state the agent returns the jabbering(4) value.</p>				
35	sessionAuthenticationTrap	sessionAccessType sessionUserName sessionUserIpAddress sessionAuthFailure	session	An authentication failure trap is sent each time a user authentication is refused.
<p>sessionAccessType—The access type of the session. sessionUserName—The user name of the user logged-in. sessionUserIpAddress—The IP address of the user logged-in.</p>				

No.	Trap Name	Objects	Family	Description
36	trapAbsorptionTrap	trapAbsorStamp trapAbsorTrapId trapAbsorCounter trapAbsorTime	none	The absorption trap is sent when a trap has been absorbed at least once.
<p>trapAbsorStamp—The time stamp of the absorbed trap. trapAbsorTrapId—The trap identifier of the absorbed trap. trapAbsorCounter—The number of the iterations of the absorbed trap. trapAbsorTime—The time stamp of the last iteration.</p>				
37	alaStackMgrDuplicateSlotTrap	alaStackMgrSlotNINumber	chassis	Two or more slots claim to have the same slot number.
<p>alaStackMgrSlotNINumber—The numbers allocated for the stack NIs are from 1 to 8.</p>				
38	alaStackMgrNeighborChangeTrap	alaStackMgrStackStatus alaStackMgrSlotNINumber alaStackMgrTrapLinkNumber	chassis	Indicates whether or not the stack is in loop.
<p>alaStackMgrStackStatus—Indicates whether the stack is or is not in a loop. alaStackMgrSlotNINumber—The numbers allocated for the stack NIs are from 1 to 8. alaStackMgrTrapLinkNumber—Holds the link number when the stack is not in a loop.</p>				
39	alaStackMgrRoleChangeTrap	alaStackMgrPrimary alaStackMgrSecondary	chassis	Indicates that a new primary or secondary stack is elected.
<p>alaStackMgrPrimary—Holds the number of the stack, which is in Primary role. alaStackMgrSecondary—Holds the number of the stack, which is in Secondary role.</p>				

No.	Trap Name	Objects	Family	Description
40	lpsViolationTrap	lpsTrap-SwitchName lpsTrapSwitchIpAddr lpsTrap-SwitchSlice lpsTrapSwitchPort lpsTrapViolatingMac lpsTrapViolationType systemServicesDate systemServicesTime	bridge	A Learned Port Security (LPS) violation has occurred.
<p>lpsTrapSwitchName—The name of the switch. lpsTrapSwitchIpAddr—The IP address of switch. lpsTrapSwitchSlice— The physical slice number for the LPS port on which the violation occurred. lpsTrapSwitchPort—The physical port number on which the violation occurred. lpsTrapViolatingMac—The violating MAC address. lpsTrapViolationType—The type of violation that occurred on the LPS port. systemServicesDate—This object contains the current System Date in the following format: MM/DD/YYYY. systemServicesTime—This object contains the current System Time in the following format: HH:MM:SS.</p>				
41	alaDoSTrap	alaDoSType alaDoSDetected	ip	Indicates that the sending agent has received a Denial of Service (DoS) attack.
<p>alaDoSType—Index field for the alaDoSTable. Integer indicating the DoS Type: 0=portscan, 1=tcpsyn, 2=pingofdeath, 3=smurf, 3=pepsi, 5=land and 6=teardropBonkBoink. alaDoSDetected—Number of attacks detected</p>				

No.	Trap Name	Objects	Family	Description
42	gmBindRuleViolation	gmBindRule- Type gmBindRu- leVlanId gmBindRuleI- PAddress gmBin- dRuleMacAd- dress gmBindRulePor- tIfIndex gmBindRulePro- toClass gmBindRuleEth- ertype gmBindRuleD- sapSsap	vlan	Occurs whenever a binding rule which has been configured gets violated.
		gmBindRuleType —Type of binding rule for which trap sent. gmBindRuleVlanId —Binding Rule VLAN Id. gmBindRuleIPAddress —Binding Rule IP address. gmBindRuleMacAddress —Binding Rule Mac Address. gmBindRulePortIfIndex —The ifIndex corresponding to the mobile port on which the binding rule violation occurred. gmBindRuleProtoClass —The encoded protocol number used for binding VLAN classification. gmBindRuleEtherType —EtherType value for generic EtherType or snap rule. This value has no meaning for vProtoRuleProtoClass set to values other than 9 or 11. gmBindRuleDsapSsap — DSAP and SSAP values for generic DSAP/SSAP and SNAP rules. This value has no meaning for vProtoRuleProtoClass set to values other than 10.		
43	unused	N/A	N/A	
44	unused	N/A	N/A	
45	unused	N/A	N/A	
46	unused	N/A	N/A	
47	pethPsePortOnOff	pethPsePortDe- tectionStatus	module	Indicates if power inline port is or is not delivering power to the a power inline device.
		pethPsePortDetectionStatus —Describes the operational status of the port PD detection. A value of disabled (1)- indicates that the PSE State diagram is in the state IDLE. A value of searching (2)- indicates that the PSE State diagram is in the state DETECTION, CLASSIFICATION, SIGNATURE_INVALID or BACKOFF. A value of deliveringPower (4) - indicates that the PSE State diagram is in the state POWER_UP, POWER_ON or POWER_OFF. A value of fault (5) - indicates that the PSE State diagram is in the state TEST_ERROR or the state IDLE due to the variable error condition. Faults detected are vendor-specific. A value of test (7) - indicates that the PSE State diagram is in the state TEST_MODE. A value of denyLowPriority (8) indicates that the port was disabled by the power management system, in order to keep active higher priority ports.		

No.	Trap Name	Objects	Family	Description
48	pethPsePortPowerMaintenanceStatus	pethPsePortPowerMaintenanceStatus	module	Indicates the status of the power maintenance signature for inline power.
<p>pethPsePortPowerMaintenanceStatus—The value ok (1) indicates the Power Maintenance Signature is present and the overcurrent condition has not been detected. The value overCurrent (2) indicates an overcurrent condition has been detected. The value mPSAbsent (3) indicates that the Power Maintenance Signature is absent.</p>				
49	pethMainPowerUsageOn	pethMainPseConsumptionPower	module	Indicates that the power inline usage is above the threshold.
<p>pethMainPseConsumptionPower—Measured usage power expressed in Watts.</p>				
50	pethMainPowerUsageOff	pethMainPseConsumptionPower	module	Indicates that the power inline usage is below the threshold.
<p>pethMainPseConsumptionPower—Measured usage power expressed in Watts.</p>				
53	httpServerDoSAttackTrap	httpConnectionStats httpsConnectionStats	webmgt	This trap is sent to management station(s) when the HTTP server is under Denial of Service attack. The HTTP and HTTPS connections are sampled at a 15 second interval. This trap is sent every 1 minute while the HTTP server detects it is under attack.
<p>httpConnectionStats—The number of HTTP connection attempts over the past 15 seconds.</p>				
54	alaStackMgrDuplicateRoleTrap	alaStackMgrSlotNINumber alaStackMgrChasRole	chassis	The element identified by alaStackMgrSlotNINumber detected the presence of two elements with the same primary or secondary role as specified by alaStackMgrChasRole on the stack.
<p>alaStackMgrSlotNINumber—Numbers allocated for the stack NIs as follows:</p> <ul style="list-style-type: none"> - 0: invalid slot number - 1..8: valid and assigned slot numbers corresponding to values from the entPhysicalTable - 1001..1008: switches operating in pass through mode - 255: unassigned slot number. 				
<p>alaStackMgrChasRole—The current role of the chassis as follows:</p> <ul style="list-style-type: none"> - unassigned(0), - primary(1), - secondary(2), - idle(3), - standalone(4), - passthrough(5). 				

No.	Trap Name	Objects	Family	Description
55	alaStackMgrClearedSlotTrap	alaStack- MgrSlotNI- Number	chassis	The element identified by alaStackMgrSlotNINumber will enter the pass through mode because its operational slot was cleared with immediate effect.
<p>alaStackMgrSlotNINumber—Numbers allocated for the stack NIs as follows:</p> <ul style="list-style-type: none"> - 0: invalid slot number - 1..8: valid and assigned slot numbers corresponding to values from the entPhysicalTable - 1001..1008: switches operating in pass through mode - 255: unassigned slot number. 				
56	alaStackMgrOutOfSlotsTrap	N/A	chassis	One element of the stack will enter the pass through mode because there are no slot numbers available to be assigned to this element.
57	alaStackMgrOutOfTokensTrap	alaStack- MgrSlotNI- Number	chassis	The element identified by alaStackMgrSlotNINumber will enter the pass through mode because there are no tokens available to be assigned to this element.
<p>alaStackMgrSlotNINumber—Numbers allocated for the stack NIs as follows:</p> <ul style="list-style-type: none"> - 0: invalid slot number - 1..8: valid and assigned slot numbers corresponding to values from the entPhysicalTable - 1001..1008: switches operating in pass through mode - 255: unassigned slot number. 				
58	alaStackMgrOutOfPassThruSlotsTrap	N/A	chassis	There are no pass through slots available to be assigned to an element that is supposed to enter the pass through mode.
59	gmHwVlanRuleTableOverloadAlert	gmOverload- RuleTable gmOverload- RuleType gmOverloadRu- leVlanId gmOverload- RuleMacAd- dress gmOverloadRu- leIpAddress gmOverload- RuleProtocol	vlan	An overload trap occurs whenever a new entry to the hardware VLAN rule table gets dropped due to the overload of the table.
<p>gmOverloadRuleTable—Overloaded hardware VLAN rule table. gmOverloadRuleType—VLAN rule types that are not configured due to the overload of the hardware VLAN rule table. gmOverloadRuleVlanId—The overloaded VLAN ID. gmOverloadRuleMacAddress—The overloaded MAC address. gmOverloadRuleIpAddress—The overloaded IP address. gmOverloadRuleProtocol—The overloaded protocol type.</p>				

No.	Trap Name	Objects	Family	Description
60	InkaggAggUp	trapInkaggId trapInkaggPortIfIndex	linkaggregation	Indicates the link aggregate is active. This trap is sent when any one port of the link aggregate group goes into the attached state.
				trapInkaggId —Index value of the Link Aggregate group. trapInkaggIfIndex —Port of the Link Aggregate group.
61	InkaggAggDown	trapInkaggId trapInkaggPortIfIndex	linkaggregation	Indicates the link aggregate is not active. This trap is sent when all ports of the link aggregate group are no longer in the attached state.
				trapInkaggId —Index value of the Link Aggregate group. trapInkaggIfIndex —Port of the Link Aggregate group.
62	InkaggPortJoin	trapInkaggId trapInkaggPortIfIndex	linkaggregation	This trap is sent when any given port of the link aggregate group goes to the attached state.
				trapInkaggId —Index value of the Link Aggregate group. trapInkaggIfIndex —Port of the Link Aggregate group.
63	InkaggPortLeave	trapInkaggId trapInkaggPortIfIndex	linkaggregation	This trap is sent when any given port detaches from the link aggregate group.
				trapInkaggId —Index value of the Link Aggregate group. trapInkaggIfIndex —Port of the Link Aggregate group.
64	InkaggPortRemove	trapInkaggId trapInkaggPortIfIndex	linkaggregation	This trap is sent when any given port of the link aggregate group is removed due to an invalid configuration.
				trapInkaggId —Index value of the Link Aggregate group. trapInkaggIfIndex —Port of the Link Aggregate group.
65	pktDrop	pktDropType pktDropIfIndex pktDropCount pktDropFrag	IP	The pktDrop trap indicates that the sending agent has dropped certain packets (to blocked IP ports, from spoofed addresses, etc.).
				pktDropType —Reason index for why the packet was dropped. pktDropIfIndex —Interface index (if_index) of the ingress port of the dropped pkt. pktDropCount —The number of packet drops (within a configured time interval) of the pktDropType that triggered this particular trap instance. pktDropFrag —Less than or equal to 512 bytes of the dropped packet (dsMac[12], tag[4], etype[2], payload[..512] (0 if DropCount only).

No.	Trap Name	Objects	Family	Description
66	monitorFileWritten	mirmonPrimarySlot mirmonPrimaryPort monitorFileName monitorFileSize	pmm	A File Written Trap is sent when the amount of data requested by the user has been written by the port monitoring instance.
<p>mirmonPrimarySlot—Slot of mirrored or monitored interface. mirmonPrimaryPort—Port of mirrored or monitored interface. monitorFileName—The name of the file in which the traffic will be stored (the default is “PMONITOR.ENC”). monitorFileSize—The number of bytes in 16K (16384) increments allowed for the file (default 16384 bytes). The file contains only the last monitorFileName bytes of the current port monitoring instance.</p>				
69	gmHwMixModeSubnetRuleTable-OverloadAlert	gmSubnetRuleTable gmOverloadRuleSlice	vlan	An subnet overload trap occurs in mixed mode whenever a new entry to the HW subnet rule table gets dropped due to the overload of the table.
<p>gmSubnetRuleTable—Overloaded HW subnet rule table. gmOverloadRuleSlice—Overloaded slot Id. Note: This trap is not supported.</p>				
70	pethPwrSupplyConflict	pethSourceSlot	chassis	This trap is sent when there is a power supply conflict in a POE device.
<p>pethSourceSlot—Slot number of generating entity.</p>				
71	pethPwrSupplyNotSupported	pethSourceSlot	chassis	This trap is sent when the power supply is not supported.
<p>pethSourceSlot—Slot number of generating entity.</p>				
72	lpsPortUpAfterLearningWindowExpiredT	lpsTrapSwitchName lpsTrapSwitchSlice lpsTrapSwitchPort systemServicesDate systemServicesTime	bridge	<p>This trap is sent when an LPS port joins or is enabled after the Learning Window is expired, disabling the MAC address learning on the port.</p> <p>This trap is also generated at the time the Learning Window expires, with a slice and port value of 0.</p>
<p>lpsTrapSwitchName—The name of the switch. lpsTrapSwitchSlice—The slot number for the LPS port on which the violation occurred lpsTrapSwitchPort—The port number for the LPS port on which the violation occurred systemServicesDate—The current System Date in the following format: MM/DD/YYYY. systemServicesTime—The current System Time in the following format: HH:MM:SS.</p>				
92	dot1agCfmFaultAlarm		bridge	A
<p>gmSubnetRuleTable—Overloaded HW subnet rule table. gmOverloadRuleSlice—Overloaded slot Id.</p>				
93	unused	N/A	N/A	N/A

No.	Trap Name	Objects	Family	Description
94	lldpRemTablesChange	lldptatsRem-TablesInserts lldptatsRem-TablesDeletes lldptatsRem-TablesDrops lldptatsRem-TablesAgeouts	aip	This trap is sent when the value of the LLDP Stats Rem Table Last ChangeTime changes. It can be utilized by an NMS to trigger LLDP remote systems table maintenance polls.
				<p>lldptatsRemTablesInserts—The number of times the complete set of information advertised by a particular MSAP has been inserted into tables contained in lldpRemoteSystemsData and lldpExtensions objects.</p> <p>lldptatsRemTablesDeletes—The number of times the complete set of information advertised by a particular MSAP has been deleted from tables contained in lldpRemoteSystemsData and lldpExtensions objects</p> <p>lldptatsRemTablesDrops—The number of times the complete set of information advertised by a particular MSAP could not be entered into tables contained in lldpRemoteSystemsData and lldpExtensions objects because of insufficient resources</p> <p>lldptatsRemTablesAgeouts—The number of times the complete set of information advertised by a particular MSAP has been deleted from tables contained in lldpRemoteSystemsData and lldpExtensions objects because the information timeliness interval has expired.</p>
95	chassisTrapsPossibleDuplicateMac	physicalIndex baseMacAddress	chassis	This trap is sent when there is a possibility of duplicate a MAC address in the network.
				<p>physicalIndex—The Physical index of the involved object.</p> <p>baseMacAddress—The base MAC Address.</p>
96	alaPimNeighborLoss	alaPimNeighborUpTime	ipmr	<p>This trap is sent when an adjacency with a neighbor is lost.</p> <p>The notification is generated when the neighbor timer expires, and the router has no other neighbors on the same interface with the same IP version and a lower IP address than itself.</p> <p>The notification is generated whenever the PIM NeighborLoss Count is incremented, subject to the rate limit specified by the PIM Neighbor Loss Notification-Period.</p>
				<p>alaPimNeighborUpTime—The time since this PIM neighbor (last) became a neighbor of the local router.</p>

No.	Trap Name	Objects	Family	Description
97	alaPimInvalidRegister	alaPimGroup- MappingPim- Mode alaPimIn- validRegis- terAddressTyp e alaPimIn- validRegister- Origin alaPimIn- validRegister- Group alaPimIn- validRegis- terRp	ipmr	This trap is sent when an invalid PIM Register message is received. The notification is generated whenever the PIM Invalid Register Message Received counter is incremented, subject to the rate limit specified by the Invalid Register NotificationPeriod.
<p>alaPimGroupMappingPimMode—The PIM mode used for groups in this group prefix.</p> <p>alaPimInvalidRegisterAddressType—The address type stored in alaPimInvalidRegisterOrigin, alaPimInvalidRegisterGroup and alaPimInvalidRegisterRp. If no unexpected Register messages are received, the object is set to “Unknown”.</p> <p>alaPimInvalidRegisterOrigin—The source address of the last unexpected Register message received by this device</p> <p>alaPimInvalidRegisterGroup—The IP multicast group address to which the last unexpected Register message received by this device was addressed.</p> <p>alaPimInvalidRegisterRp—The RP address to which the last unexpected Register message received by this device was delivered.</p>				
98	alaPimInvalidJoinPrune	alaPimGroup- MappingPim- Mode alaPimInvali- dJoinPruneAd- dressType alaPimInvali- dJoinPruneOr- igin alaPimInvali- dJoinPrune- Group alaPimInvali- dJoinPruneRp alaPimNeigh- borUpTime	ipmr	This trap is sent when an invalid PIM Join/Prune message is received. The notification is generated whenever the PIM Invalid Join Prune Messages Received counter is incremented, subject to the rate limit specified by the PIM Invalid Join/Prune Notification Period.
<p>alaPimGroupMappingPimMode—The PIM mode used for groups in this group prefix.</p> <p>alaPimInvalidRegisterAddressType—The address type stored in alaPimInvalidRegisterOrigin, alaPimInvalidRegisterGroup and alaPimInvalidRegisterRp. If no unexpected Register messages are received, the object is set to “Unknown”.</p> <p>alaPimInvalidJoinPruneOrigin—The source address of the last unexpected Join/Prune message received</p> <p>alaPimInvalidJoinPruneGroup—The IP multicast group address carried in the last unexpected Join/Prune message received</p> <p>alaPimInvalidJoinPruneRp—The RP address carried in the last unexpected Join/Prune message received</p> <p>alaPimNeighborUpTime—The time since this PIM neighbor (last) became a neighbor of the local router.</p>				

No.	Trap Name	Objects	Family	Description
99	alaPimRPMappingChange	alaPimGroup- MappingPim- Mode alaPimGroup- MappingPre- cedence	ipmr	This trap is sent when a change is detected to the active RP mapping on the device. The notification is generated whenever the PIM RP Mapping Change Count is incremented, subject to the rate limit specified by PIM RP Mapping Change Notification Period
<p>alaPimGroupMappingPimMode—The PIM mode used for groups in this group prefix. alaPimGroupMappingPrecedence—The value for alaPimGroupMappingPrecedence to be used for this static RP configuration. This allows fine control over which configuration is overridden by this static configuration</p>				
100	alaPimInterfaceElection	alaPimInter- faceAddress- Type alaPimInter- faceAddress	ipmr	This trap is sent when a new DR or DR has been elected on a network. The notification is generated whenever the counter PIM Interface Elections Win Count is incremented, subject to the rate limit specified by PIM Interface Election Notification Period.
<p>alaPimInterfaceAddressType—The address type of the PIM interface. alaPimInterfaceAddress—The primary IP address of this router on this PIM interface.</p>				
101	lpsLearnTrap	lpsLearnTrap- Threshold	bridge	This trap is sent when the number of bridged MACs learned matches the configured Learned Trap Threshold. A trap is then generated or every additional MAC that is learned.
<p>lpsLearnTrapThreshold—The number of bridged MAC addresses that can be learned before a trap is sent.</p>				
102	gvrpVlanLimitReachedEvent	alaGvrpMax- VlanLimit	bridge	This trap is sent when the number of dynamically-learned VLANs has reached the configured limit.
<p>alaGvrpMaxVlanLimit—The maximum number of dynamic VLANs that can be created on the system by GVRP before a trap is sent.</p>				
<p>alaNetSecPortTrapInfoIfId—The interface index of port on which anomaly is detected.</p>				
105	udldStateChange	alaUdldPortIfIn- dex alaUdld- PrevState alaUdldCurrent- State	interface	This trap is sent when the UDLD state of a port has changed.
<p>alaUdldPortIfIndex—The interface index of the port which triggered the UDLD trap. alaUdldPrevState—The previous UDLD state of the port - notapplicable (0), shutdown (1), undetermined (2), bidirectional (3). alaUdldCurrentState—The current UDLD state of the port - notapplicable (0), shutdown (1), undetermined (2), bidirectional (3).</p>				

No.	Trap Name	Objects	Family	Description
106	healthMonIpcTrap	healthMonIpcPoolStatus	health	This trap is sent when IPC Pools exceed usage. healthMonIpcPoolStatus —The IPC Pools usage status.
107	bcmHashCollisionTrap	?	eth	This trap is sent when ? bcmHashCollisionTrap —The ?
108	healthMonCpuShutPortTrap	healthModuleSlot ifIndex healthModuleCpuLatest	health	This trap is sent when port is shut down because of a CPU spike. healthModuleSlot —The slot on which anomaly is detected. ifIndex —The port on which anomaly is detected. healthModuleCpuLatest —The average module-level CPU utilization over the latest sample period (percent).
109	arpMaxLimitReached	none	ip	This trap is sent when the hardware table has reached the maximum number of entries supported. The OmniSwitch will not generate new ARP request for new nexthops.
110	ndpMaxLimitReached	none	ipv6	This trap is sent when the hardware table has reached the maximum number of entries supported. The OmniSwitch will not generate new ARP request for new nexthops.
111	ripRouteMaxLimitReached	none	rip	This trap is sent when the RIP database reaches the supported maximum number of entries. When the maximum number is reached, RIP discards any new updates.
112	ripngRouteMaxLimitReached	none	ripng	This trap is sent when the RIPng database reaches the supported maximum number of entries. When the maximum number is reached, RIPng discards any new updates.
113	- Reserved			
118				

No.	Trap Name	Objects	Family	Description
119	dot3OamThresholdEvent	dot3OamEvent-LogTimestamp dot3OamEvent-LogOui dot3OamEvent-LogType dot3OamEvent-LogLocation dot3OamEvent-LogWindowHi dot3OamEvent-LogWindowLo dot3OamEvent-LogThresholdHi dot3OamEvent-LogThresholdLo dot3OamEvent-LogValue dot3OamEvent-LogRunningTotal dot3OamEvent-LogEventTotal	dot3-oam	This trap is sent when a local or remote threshold crossing event is detected. A local threshold crossing event is detected by the local entity, while a remote threshold crossing event is detected by the reception of an Ethernet OAM Event Notification OAMPDU that indicates a threshold event.

dot3OamEventLogTimestamp—The sysUpTime at the time of the logged event.

dot3OamEventLogOui—The OUI of the entity defining the object type. All IEEE 802.3 defined events (as appearing in [802.3ah] except for the Organizationally Unique Event TLVs) use the IEEE 802.3 OUI of 0x0180C2. Organizations defining their own Event Notification TLVs include their OUI in the Event Notification TLV that is reflected here.

dot3OamEventLogType—The type of event that generated this entry in the event log. When the OUI is the IEEE 802.3 OUI of 0x0180C2, the following event types are defined: erroredSymbolEvent(1), erroredFramePeriodEvent(2), erroredFrameEvent(3), erroredFrameSecondsEvent(4), linkFault(256), dyingGaspEvent(257), criticalLinkEvent(258).

dot3OamEventLogLocation—Indicates whether this event occurred locally (local(1)), or was received from the OAM peer via Ethernet OAM (remote(2)).

dot3OamEventLogWindowHi—The time interval, in seconds, that is used to monitor the “High” threshold limit for this event. A notification is sent every time the threshold is exceeded during any 5-second monitoring interval.

dot3OamEventLogWindowLo—The time interval, in seconds, that is used to monitor the “Low” threshold limit for this event. A notification is sent every time the threshold is exceeded during any 5-second monitoring interval.

dot3OamEventLogThresholdHi—The “High” threshold level set for the event.

dot3OamEventLogThresholdLo—The “Low” threshold level set for the event.

dot3OamEventLogValue—The value of the event when it exceeded a threshold limit.

dot3OamEventLogRunningTotal—the total number of times this event has happened since the last reset

dot3OamEventLogEventTotal—The total number of times this event has resulted in a notification.

No.	Trap Name	Objects	Family	Description
120	dot3OamNonThresholdEvent	dot3OamEvent-LogTimestamp dot3OamEvent-LogOui dot3OamEvent-LogType dot3OamEvent-LogLocation dot3OamEvent-LogEventTotal	dot3-oam	This trap is sent when a local or remote non-threshold crossing event is detected. A local event is detected by the local entity, while a remote event is detected by the reception of an Ethernet OAM Event Notification OAMPDU that indicates a non-threshold crossing event.
<p>dot3OamEventLogTimestamp—The value of sysUpTime at the time of the logged event.</p> <p>dot3OamEventLogOui—The OUI of the entity defining the object type. All IEEE 802.3 defined events (as appearing in [802.3ah] except for the Organizationally Unique Event TLVs) use the IEEE 802.3 OUI of 0x0180C2. Organizations defining their own Event Notification TLVs include their OUI in the Event Notification TLV that gets reflected here.</p> <p>dot3OamEventLogType—The type of event that generated this entry in the event log. When the OUI is the IEEE 802.3 OUI of 0x0180C2, the following event types are defined: erroredSymbolEvent(1), erroredFramePeriodEvent(2), erroredFrameEvent(3), erroredFrameSecondsEvent(4), linkFault(256), dyingGaspEvent(257), criticalLinkEvent(258).</p> <p>dot3OamEventLogLocation—Indicates whether this event occurred locally (local(1)), or was received from the OAM peer via Ethernet OAM (remote(2)).</p> <p>dot3OamEventLogEventTotal—The total number of times this event has resulted in a notification.</p>				
121	alaDot3OamThresholdEventClear	dot3OamEvent-LogTimestamp dot3OamEvent-LogOui dot3OamEvent-LogType dot3OamEvent-LogLocation dot3OamEvent-LogWindowHi dot3OamEvent-LogWindowLo dot3OamEvent-LogThresholdHi dot3OamEvent-LogThresholdLo dot3OamEvent-LogValue dot3OamEvent-LogRunningTotal dot3OamEvent-LogEventTotal	dot3-oam	This trap is sent when is sent when a local or remote threshold crossing event is recovered.

No.	Trap Name	Objects	Family	Description
		<p>dot3OamEventLogTimestamp—The sysUpTime at the time of the logged event.</p> <p>dot3OamEventLogOui—The OUI of the entity defining the object type. All IEEE 802.3 defined events (as appearing in [802.3ah] except for the Organizationally Unique Event TLVs) use the IEEE 802.3 OUI of 0x0180C2. Organizations defining their own Event Notification TLVs include their OUI in the Event Notification TLV that is reflected here.</p> <p>dot3OamEventLogType—The type of event that generated this entry in the event log. When the OUI is the IEEE 802.3 OUI of 0x0180C2, the following event types are defined: erroredSymbolEvent(1), erroredFramePeriodEvent(2), erroredFrameEvent(3), erroredFrameSecondsEvent(4), linkFault(256), dyingGaspEvent(257), criticalLinkEvent(258).</p> <p>dot3OamEventLogLocation—Indicates whether this event occurred locally (local(1)), or was received from the OAM peer via Ethernet OAM (remote(2)).</p> <p>dot3OamEventLogWindowHi—The time interval, in seconds, that is used to monitor the “High” threshold limit for this event. A notification is sent every time the threshold is exceeded during any 5-second monitoring interval.</p> <p>dot3OamEventLogWindowLo—The time interval, in seconds, that is used to monitor the “Low” threshold limit for this event. A notification is sent every time the threshold is exceeded during any 5-second monitoring interval.</p> <p>dot3OamEventLogThresholdHi—The “High” threshold level set for the event.</p> <p>dot3OamEventLogThresholdLo—The “Low” threshold level set for the event.</p> <p>dot3OamEventLogValue—The value of the event when it exceeded a threshold limit.</p> <p>dot3OamEventLogRunningTotal—the total number of times this event has happened since the last reset</p> <p>dot3OamEventLogEventTotal—The total number of times this event has resulted in a notification.</p>		
122	alaDot3OamNonThresholdEventClear	dot3OamEvent- LogTimestamp dot3OamEvent- LogOui dot3OamEvent- LogType dot3OamEvent- LogLocation dot3OamEvent- LogEventTotal	dot3-oam	This trap is sent is sent when a local or remote non-threshold crossing event is recovered.
		<p>dot3OamEventLogTimestamp—The value of sysUpTime at the time of the logged event.</p> <p>dot3OamEventLogOui—The OUI of the entity defining the object type. All IEEE 802.3 defined events (as appearing in [802.3ah] except for the Organizationally Unique Event TLVs) use the IEEE 802.3 OUI of 0x0180C2. Organizations defining their own Event Notification TLVs include their OUI in the Event Notification TLV that gets reflected here.</p> <p>dot3OamEventLogType—The type of event that generated this entry in the event log. When the OUI is the IEEE 802.3 OUI of 0x0180C2, the following event types are defined: erroredSymbolEvent(1), erroredFramePeriodEvent(2), erroredFrameEvent(3), erroredFrameSecondsEvent(4), linkFault(256), dyingGaspEvent(257), criticalLinkEvent(258).</p> <p>dot3OamEventLogLocation—Indicates whether this event occurred locally (local(1)), or was received from the OAM peer via Ethernet OAM (remote(2)).</p> <p>dot3OamEventLogEventTotal—The total number of times this event has resulted in a notification.</p>		
123	- Reserved			
146				

No.	Trap Name	Objects	Family	Description
147	halHashCollisionTrap	halHashCollisionMac, halHashCollisionSlot, halHashCollisionPort, halHashCollisionVlan, halHashCollisionTable	bridge	Trap to notify of a hash collision in BCM table.
		<p>halHashCollisionMac—MAC for which the collision occurred. halHashCollisionSlot—Physical slot number on which the collision MAC tried to be added. halHashCollisionPort—Physical port number on which the collision MAC tried to be added. halHashCollisionVlan—The VLAN ID on which the collision MAC tried to be added. halHashCollisionTable—The BCM table in which the collision occurred.</p>		
148	alaLbdStateChangeToShutdown	alaLbdPortIfIndex, alaLbdPreviousState, alaLbdCurrentState	lbd	When the port state is changed to shutdown, a notification is sent to the Management Entity with the LBD-state information.
		<p>alaLbdPortIfIndex—The ifIndex of the port on which LBD trap is raised. alaLbdPreviousState—The previous state of the port on which LBD was running. alaLbdCurrentState—The current state of the port on which LBD was running.</p>		
149	alaLbdStateChangeForClearViolation-All	alaLbdPortIfIndex, alaLbdPreviousStateClearViolationAll, alaLbdCurrentStateClearViolationAll	lbd	When the the port state changes from shutdown due to clear-violation-all, a notification is sent to the Management Entity, with the LBD-state information.
		<p>alaLbdPortIfIndex—The ifIndex of the port on which LBD trap is raised. alaLbdPreviousStateClearViolationAll—The state of the port where LBD was running before clear-violation-all applied. alaLbdCurrentStateClearViolationAll—The state of the port where LBD was running after clear-violation-all applied.</p>		
150	alaLbdStateChangeForAutoRecovery	alaLbdPortIfIndex, alaLbdPreviousStateAutoRecovery, alaLbdCurrentStateAutoRecovery	lbd	When the port state changes from shutdown due to auto-recovery mechanism, a notification is sent to the Management Entity with the LBD-state information.
		<p>alaLbdPortIfIndex—The ifIndex of the port on which LBD trap is raised. alaLbdPreviousStateAutoRecovery—The state of the port where LBD was running before auto-recovery. alaLbdCurrentStateAutoRecovery—The state of the port where LBD was running after auto-recovery.</p>		
151	- Reserved			
152				

No.	Trap Name	Objects	Family	Description
153	alaErpRingPortStatusChanged	alaErpRingId, alaErpRing- PortIfIndex, alaErpRing- PortStatus	bridge	This trap is sent when the ring port status is changed.
<p>alaErpRingId—The Ring identifier that is unique in the bridge. alaErpRingPortIfIndex—The interface index - either a bridge port, or an aggregated link within a bridge port, to which ring port is configured. alaErpRingPortStatus—The status of the ring port.</p>				
154	- Reserved			
158				
159	alaDhcpClientAddressAddTrap	alaDhcpClientAddress	ip-helper	This trap is sent when a new IP address is assigned to a DHCP client interface.
<p>alaDhcpClientAddress—The current IP address of the DHCP client.</p>				
160	alaDhcpClientAddressExpiryTrap	alaDhcpClientAddress	ip-helper	This trap is sent when the lease time expires or when a DHCP client unable to renew/rebind an IP address.
<p>alaDhcpClientAddress—The current IP address of the DHCP client.</p>				
161	alaDhcpClientAddressModifyTrap	alaDhcpClientAddress, alaDhcpClientNewAddress	ip-helper	This trap is sent when the DHCP client unable to obtain the existing IP address and a new IP address is assigned to the DHCP client.
<p>alaDhcpClientAddress—The current IP address of the DHCP client. alaDhcpClientNewAddress—The new IP address assigned to the DHCP client.</p>				
162	alaDyingGaspTrap	alaDyingGaspSlot, alaDyingGaspPowerSupplyType, alaDyingGaspTime	interface	This trap is sent when a switch has lost all power.
<p>alaDyingGaspSlot—The slot number of the chassis whose NI is going down. alaDyingGaspPowerSupplyType—The type of the power supply. alaDyingGaspTime—The time of the failure.</p>				
163	alaTestOamTxDoneTrap	alaTestOamConfigTestId, alaTestOamConfigSourceEndpoint, alaTestOamConfigTestIdStatus	bridge	After a configured time interval, this trap is sent to the NMS from Generator switch when the test duration expires.
<p>alaTestOamConfigTestId—A unique name to identify the entries in the table. alaTestOamConfigSourceEndpoint—The the local or transmitting switch. For bidirectional test, this also identifies the analyzer switch. alaTestOamConfigTestIdStatus—The test status (not started, running, stopped, ended).</p>				

No.	Trap Name	Objects	Family	Description
164	alaTestOamRxReadyTrap	alaTestOamConfigTestId, alaTestOamConfigSourceEndpoint, alaTestOamConfigTestIdStatus	bridge	This trap is sent to the NMS once the switch with Analyzer or Loopback Role is ready to receive test traffic. Once this trap is received, the Generator is activated for generating test traffic.
<p>alaTestOamConfigTestId—A unique name to identify the entries in the table. alaTestOamConfigSourceEndpoint—The the local or transmitting switch. For bidirectional test, this also identifies the analyzer switch. alaTestOamConfigTestIdStatus—The test status (not started, running, stopped, ended).</p>				
165	alaTestOamTestAbortTrap	alaTestOamConfigTestId	bridge	This trap is sent to the NMS from the switch, if the test is aborted during takeover.
<p>alaTestOamConfigTestId—A unique name to identify the entries in the table.</p>				
166	Reserved			
167	Reserved			
168	alaSaaPIterationCompleteTrap	alaSaaCtrlOwnerIndex, alaSaaCtrlTestIndex, alaSaaIpResultsTestRunIndex, alaSaaCtrlLastRunResult, alaSaaCtrlLastRunTime	system	This trap is sent when an IP SAA iteration is completed.
<p>alaSaaCtrlOwnerIndex—An owner name to identify entries in the table. This is currently not supported and its value will always be the string 'USER'. alaSaaCtrlTestIndex—A unique name to identify the entries in the table. The name is unique across various SNMP users. alaSaaIpResultsTestRunIndex—Identifies the row entry that reports results for a single OAM test run. The value of this object starts from 1 and can go upto a maximum of alaSaaCtrlMaxHistoryRows. alaSaaCtrlLastRunResult—The result of the latest SAA test iteration: 1 - Undetermined, 2 - Success, 3 - Failed, 4 - Aborted. alaSaaCtrlLastRunTime—The date and time at which the last iteration of the SAA was run.</p>				

No.	Trap Name	Objects	Family	Description
169	alaSaaEthIterationCompleteTrap	alaSaaCtrlOwnerIndex, alaSaaCtrlTestIndex, alaSaaEthoamResultsTestRunIndex, alaSaaCtrlLastRunResult, alaSaaCtrlLastRunTime	system	This trap is sent is sent when a Eth-LB or Eth-DMM SAA iteration is completed.
<p>alaSaaCtrlOwnerIndex—An owner name to identify entries in the table. This is currently not supported and its value will always be the string 'USER'.</p> <p>alaSaaCtrlTestIndex—A unique name to identify the entries in the table. The name is unique across various SNMP users.</p> <p>alaSaaEthoamResultsTestRunIndex—Identifies the row entry that reports results for a single Eth-LB/DMM test run. The value of this object starts from 1 and can go upto a maximum of alaSaaCtrlMaxHistoryRows.</p> <p>alaSaaCtrlLastRunResult—The result of the latest SAA test iteration: 1 - Undetermined, 2 - Success, 3 - Failed, 4 - Aborted.</p> <p>alaSaaCtrlLastRunTime—The date and time at which the last iteration of the SAA was run..</p>				
170	alaSaaMacIterationCompleteTrap	alaSaaCtrlOwnerIndex alaSaaCtrlTestIndex, alaSaaMacResultsTestRunIndex, alaSaaCtrlLastRunResult, alaSaaCtrlLastRunTime	system	This trap is sent is sent when a MAC SAA iteration is completed.
<p>alaSaaCtrlOwnerIndex—An owner name to identify entries in the table. This is currently not supported and its value will always be the string 'USER'.</p> <p>alaSaaCtrlTestIndex—A unique name to identify the entries in the table. The name is unique across various SNMP users.</p> <p>alaSaaMacResultsTestRunIndex—Identifies the row entry that reports results for a single test run. The value of this object starts from 1 and can go upto a maximum of alaSaaCtrlMaxHistoryRows.</p> <p>alaSaaCtrlLastRunResult—The result of the latest SAA test iteration: 1 - Undetermined, 2 - Success, 3 - Failed, 4 - Aborted.</p> <p>alaSaaCtrlLastRunTime—The date and time at which the last iteration of the SAA was run.</p>				
171	aaaHicServerChangeTrap	aaaHSvrIpAddress, aaaHSvrCurrIpAddress	aaa	This trap is sent when the active HIC server is changed from.to primary.
<p>aaaHSvrIpAddress—The HIC/Rem/WebDL server's IP address.</p> <p>aaaHSvrCurrIpAddress—The current active HIC server's IP address.</p>				

No.	Trap Name	Objects	Family	Description
172	aaaHicServerUpTrap	aaaHSvrIpAddress, aaaHSvrRole, aaaHSvrName	aaa	This trap is sent when at least one of the HIC servers comes UP.
<p>aaaHSvrIpAddress—The HIC/Rem/WebDL server's IP address. aaaHSvrRole—The HIC Server's role. aaaHSvrName—The HIC Server's name.</p>				
173	alaLldpTrustViolation	agentreadyex- istonport , agentreadyex- istonotherport, chassisidsub- typemismatch	aip	This trap is sent when there is an LLDP Trust Violation, and gives the reason for the violation.
<p>agentreadyexistonport (1)—There is already one trust agent exists on the port. Only one trust agent can be allowed on a port. agentreadyexistonotherport (2)—The same agent is already present on another port. Any given remote agent shall be part of only on port. chassisidsubtypemismatch (3)—The Chassis ID subtype does not match the configured subtype.</p>				
174	alaStackMgrIncompatibleModeTrap		chassis	Not Supported
175	Reserved			
176	alaDHLVlanMoveTrap	alaDHLSessionID, alaDHLPort- From, alaDHLPortTo, alaDHLVlan- MoveReason	vlan	When linkA or linkB goes down or comes up and both ports are part of some vlan-map, this trap is sent to the Management Entity, with the DHL port information.
<p>alaDHLSessionID—The DHL Session ID for which alaDHLVlanMoveTrap needs to be sent to the Management Entity. alaDHLPortFrom—The the port, either linkA or linkB, from whichvlan-mapped vlans have joined to other port due to linkUp or linkDown as specified by alaDHLVlanMoveReason. alaDHLPortTo—The the port, either linkA or linkB, to which vlan-mapped vlans have joined from other port due to linkUp or linkDown as specified by alaDHLVlanMoveReason alaDHLVlanMoveReason—The reason for Vlan Movement from one port to another port.</p>				
177	esmPortViolation	ifIndex, esmPortViola- tionValue	interface	This trap is sent when an interface is shut down by a feature due to violation.

No.	Trap Name	Objects	Family	Description
				<p>ifIndex—The interface that was shut down due to the violation.</p> <p>esmPortViolationValue—The reason the interface was shut down.</p>
	EniSecurityBlockPortNone(0)	No App blocking this port		
	EniSecurityBlockPortENI(1)	ENI App blocking this port		
	EniSecurityBlockPortSTP(2)	STP App blocking this port		
	EniSecurityBlockPortLPSS(3)	LPS Shutdown App blocking this port		
	EniSecurityBlockPortQoS(4)	QoS App blocking this port		
	EniSecurityBlockPortUDLD(5)	UDLD App blocking this port		
	EniSecurityBlockPortETHBLK(6)	ETHBLK App blocking this port		
	EniSecurityBlockPortNISUP(7)	NISUP App blocking this port		
	EniSecurityBlockPortLLDP(8)	LLDP App blocking this port		
	EniSecurityBlockPortRFP(9)	RFP App blocking this port		
	EniSecurityBlockPortLinkMon(10)	LinkMon App blocking this port		
	EniSecurityBlockPortLFP(11)	LFP App blocking this port		
	EniSecurityBlockPortLPSD(12)	LPS Discard App blocking this port		
178	Reserved			
179	Reserved			
180	alaTestOamTxDoneTrap	alaTestOamConfigTestId, alaTestOamConfigSourceEndpoint, alaTestOamConfigTestIdStatus	bridge	After a configured time interval, this trap is sent to the NMS from Generator switch when the test duration expires.
				<p>alaTestOamConfigTestId—A unique name to identify the entries in the table.</p> <p>alaTestOamConfigSourceEndpoint—The the local or transmitting switch. For bidirectional test, this also identifies the analyzer switch.</p> <p>alaTestOamConfigTestIdStatus—The test status (not started, running, stopped, ended).</p>
181	alaTestOamRxReadyTrap	alaTestOamConfigTestId, alaTestOamConfigSourceEndpoint, alaTestOamConfigTestIdStatus	bridge	This trap is sent to the NMS once the switch with Analyzer or Loopback Role is ready to receive test traffic. Once this trap is received, the Generator is activated for generating test traffic.
				<p>alaTestOamConfigTestId—A unique name to identify the entries in the table.</p> <p>alaTestOamConfigSourceEndpoint—The the local or transmitting switch. For bidirectional test, this also identifies the analyzer switch.</p> <p>alaTestOamConfigTestIdStatus—The test status (not started, running, stopped, ended).</p>
182	alaTestOamTestAbortTrap	alaTestOamConfigTestId	bridge	This trap is sent to the NMS from the switch, if the test is aborted during takeover.
				<p>alaTestOamConfigTestId—A unique name to identify the entries in the table.</p>

No.	Trap Name	Objects	Family	Description
183	alaDhcpBindingDuplicateEntry	iphelperDhcpSnoopingBindingMacAddress, iphelperDhcpSnoopingBindingVlan, iphelperDhcpSnoopingBindingIfIndex,		This trap is sent to notify the user of MAC Movement in DHCP-Binding Table.
		<p>iphelperDhcpSnoopingBindingMacAddress—The MAC Address subindex identifying this instance.</p> <p>iphelperDhcpSnoopingBindingVlan—The DHCP client VLAN.</p> <p>iphelperDhcpSnoopingBindingIfIndex—The IfIndex subindex identifying this instance. It is the interface from which the where the DHCP request is coming.</p>		
184	esmStormThresholdViolationStatus			Not Supported
185	Reserved			
186	Reserved			
187	Reserved			
188	poePowerBudgetChange			Not Supported
189	alaDBChange	alaOldDb, alaNewDb, alaModuleChangeString	port	This trap is sent when there is a change in the expansion module presence. Please note that if the old module and new module, defined by AlaDBType, are same, then this trap will not be sent.
		<p>alaOldDb—The daughter module that was present before inserting a new module.</p> <p>alaNewDb—The daughter module that was inserted.</p> <p>alaModuleChangeString—Specifies the string value describing: 1) Reboot is required to activate the new module. 2) New module can be used without reboot. 3) No expansion module is present.</p>		
190	alaStackMgrIncompatibleLicenseTrap	alaStackMgrSlotNINumber, alaStackMgrPrimaryLicense	chassis	This trap is sent when an interface enters the pass through mode because element license information is not same as primary element license information.
		<p>alaStackMgrSlotNINumber—The number assigned for NI Stack.</p> <p>alaStackMgrPrimaryLicense—The stack element license type.</p>		
191	Reserved			

No.	Trap Name	Objects	Family	Description
192	Reserved			
193	Reserved			
194	Reserved			
195	Reserved			
196	Reserved			
197	Reserved			
198	aluLicenseManagerLicenseExpired	aluLicensedApplication aluLicenseTimeRemaining	license manager	This trap is sent when the value of aluLicenseTimeRemaining becomes 0 (zero) for a demo licensed application. This notification is applicable only for temporary licenses. This trap can be utilized by an NMS to inform user about an application license expiration.
<p>aluLicensedApplication—String displaying the application for which this license is valid. aluLicenseTimeRemaining—Number of days remaining to evaluate this demo license.</p>				
199	Reserved			
-				
225				

No.	Trap Name	Objects	Family	Description
226	configSaveSucceededTrap	configMgrTraps-Group configMgrTrapReasonGroup configSaveSucceededTrap configSaveSucceededTrapReason	config manager	<p>This trap is sent from existing Configuration Manager Task when configuration is saved. Existing socket between the Configuration Manager and the Trap Manager is used for sending trap. SAM is informed of the changes in switch configuration with SNMP traps allowing. Switches are polled when the configuration is saved.</p> <p>This is done by checking the configuration file periodically using CLI, SNMP or Webview. The trap can also be raised using "debug trap generate" command, "write memory", "write memory flash-synchro", and "copy running-config working" commands</p>
<p>configSaveSucceededTrap—Generated when the saving of configuration finishes without errors. configSaveSucceededTrapReason—Specifies the reason of trap for successful execution of write memory command. configMgrTrapsGroup—Collection of Traps for Configuration Manager. configMgrTrapReasonGroup—Configurations saved successfully by write memory command.</p>				
227	Reserved			
-				
229				
230	alaStackSplitProtectionTrap	alaStackMgrSlotNINumber	chassis	This trap is sent when an element of the stack enters into the Protection state.
alaStackMgrSlotNINumber —The slot number of the stack that entered the Protection state.				
231	alaStackSplitRecoveryTrap	alaStackMgrSlotNINumber	chassis	This trap is sent when an element of the stack recovers from the Protection state.
alaStackMgrSlotNINumber —The slot number of the stack that entered the Protection state.				
232	Reserved			
233	systemSwlogSizeTrap	systemSwlogName	system	The size of the specified file has exceeded 90 percent of preconfigured value.
systemSwlogName —SWLOG file name whose size exceeded preconfigured value.				
234	alaTestOamStatsWriteDoneTrap	alaTestOamStatsWriteDoneStr	bridge	This trap is sent when the maximum number of stats records have been written to the testoam stats file maintained in /flash.
alaTestOamStatsWriteDoneStr —The string mentioning that the maximum number of records have been written on the flash.				
235	Reserved			

No.	Trap Name	Objects	Family	Description
236	aaaRadiusServerUpTrap	aaasIpAddress, aaasIpAddress2	aaa	AAA RADIUS server Up trap is sent when the server is reachable. aaasIpAddress —IP address of the server host. aaasIpAddress2 —IP address of the backup server host.
237	aaaRadiusServerDownTrap	aaasIpAddress, aaasIpAddress2	aaa	AAA RADIUS server Up trap is sent when the server is unreachable. aaasIpAddress —IP address of the server host. aaasIpAddress2 —IP address of the backup server host.
238	alaNtpActiveServerChangeTrap	alaNtpSyncPeerIpAddress	ntp	Notify the management entity when the NTP active server changes. alaNtpSyncPeerIpAddress —IP address of the currently synchronised NTP server.
239	alaNtpAllPeerUnreachableTrap	alaNtpAllServerDown	ntp	Notify the management entity that all the configured NTP servers are unreachable. alaNtpAllServerDown —All configured NTP servers are unreachable.

Index

Symbols

!! command 6-12

Numerics

802.1AB
verify information about 3-31

A

aaa authentication command 10-7, 10-8, 10-10, 11-5

aaa radius-server command 10-7

accounting

for Authenticated Switch Access 10-12

ACE/Servers 10-4

application examples

applying configuration files 7-4

Authenticated Switch Access 10-7

CLI 6-9, 6-25

CMM 5-5

configuration file 7-2

customer login user accounts 9-8

Emergency Restore 5-32

file management 1-31

logging into the switch 2-5

network administrator user accounts 9-7

NTP 4-3

Prefix Recognition 6-14

Server Load Balancing 3-30

SNMP 3-4

Trap Filters 3-5

WebView 11-5

applying configuration files

application examples 7-4

ASA

see Authenticated Switch Access

ASA Configuration

verify information about 10-13, 10-19

Authenticated Switch Access 10-4

accounting 10-12

application examples 10-7

management interfaces 10-9

authentication

MD5 3-11

SHA 3-11

traps 3-15

Automatic Remote Configuration 8-5

Bootup Configuration File 8-12

Debug Configuration File 8-12

Firmware upgrade Files 8-12

Instruction File 8-12

Script File 8-12

Troubleshooting 8-23

Automatic Remote Configuration network components 8-6

TFTP File Server 8-6

B

banner

login 2-22

pre-login text 2-23

boot.cfg file 5-3, 5-16

Emergency Restore 5-34

C

cd command 1-9

certified directory 5-3

copying to working directory 5-22, 5-27

Chassis Management Module

see CMM

chmod command 1-16

CLI 6-1

application examples 6-9, 6-25

domains and families 9-21

logging commands 6-17–6-18

specifications 6-2

CLI usage

verify information about 6-27

CMM 5-1

application examples 5-5

boot.cfg file 5-3

cancelling a reboot 5-14, 5-20, 5-25

certified directory 5-3

checking reboot status 5-15

configuration files 5-3

copying

certified directory to working directory 5-22, 5-27

running configuration to working directory 5-16

working directory to certified directory 5-21, 5-26

displaying current configuration 5-23, 5-30

displaying switch files 5-24

image files 5-3

managing 5-13

rebooting 5-13, 5-25

rebooting from the working directory 5-18, 5-26

running configuration 5-3, 5-4

scheduling a reboot 5-14, 5-25

specifications 5-2

swapping primary for secondary 5-29

synchronizing primary and secondary 5-26, 5-27

working directory 5-3

CMM Conditions

verify information about 5-36

CMM scenarios 5-5

lost running configuration 5-5

rollback to previous software 5-8

running configuration saved to working directory 5-6

working directory saved to certified directory 5-7

Command Line Interface

see CLI

- commands
 - domains and families 10-17
 - community strings 3-10
 - configuration apply command 7-2, 7-4
 - for a specific timeperiod 7-5
 - configuration cancel command 7-7
 - configuration error-file limit command 7-8
 - configuration file
 - application examples 7-2
 - specifications 7-2
 - configuration files 5-3, 6-3
 - errors 7-7
 - configuration snapshot all command 7-12
 - configuration syntax check 7-8
 - console port 2-6
 - copy certified working command 5-22
 - copy flash-synchro command 5-28
 - copy running-config working command 5-17
 - copy working certified flash-synchro command 5-26
 - cp command 5-34
 - customer login user accounts
 - application examples 9-8
- D**
- date 1-41, 7-4
 - Daylight Savings Time
 - see DST
 - defaults
 - login 2-3
 - NTP 4-2
 - SNMP 3-3
 - startup 9-6
 - switch security 10-2
 - user accounts 9-2
 - WebView 11-2
 - delete command 1-16
 - DES encryption 3-11
 - dir command 1-10
 - directories
 - certified 1-28, 5-3
 - flash 1-8
 - managing 5-13
 - network 1-28
 - working 1-28, 5-3
 - Directory Contents
 - verify information about 1-37
 - DNS resolver 2-25
 - Domain Name Server
 - see DNS resolver
 - DSA key
 - Secure Shell 10-11
 - DST 1-43
- E**
- editor
 - vi 7-9
 - Emergency Restore
 - application examples 5-32
- F**
- File Configuration
 - verify information about 7-14
 - file management
 - application examples 1-31
 - specifications 1-2
 - files
 - attributes 1-16
 - boot.cfg 5-3
 - configuration 5-3
 - image 5-3
 - names 7-11
 - permissions 1-16
 - snapshots 7-10
 - text 7-9
 - filters 6-21
 - traps 3-5
 - freespace command 1-18
 - fsck command 1-18
 - FTP 2-10
 - FTP client 1-22, 2-10
 - ftp command 1-22, 1-23, 2-10, 2-11
 - FTP server 1-21
 - ftp6 command 1-23
- H**
- help 6-7
 - HTTP
 - web browser 2-7
 - http port command 11-3
 - http server command 11-3
 - http ssl command 11-4
 - https
 - [//service.esd.alcatel-lucent.com/portal/page/portal/EService/LicenseGeneration](https://service.esd.alcatel-lucent.com/portal/page/portal/EService/LicenseGeneration) 1-38
 - https port command 11-4
- I**
- image files 5-3
 - ip domain-lookup command 2-25
 - ip domain-name command 2-25
 - ip name-server command 2-25
- K**
- keywords 6-6
- L**
- LDAP accounting servers

- Authenticated Switch Access 10-12
- LDAP servers
 - for switch security 10-4
- logging into the switch
 - application examples 2-5
- login
 - defaults 2-3
 - specifications 2-3
- login banner 2-22
- login settings
 - verify information about 2-26
- ls command 1-6, 1-10, 6-12
- ls-r command 1-13

M

- Management Information Bases
 - see MIBs
- MD5
 - authentication 3-11
- memory 1-18
- MIBs
 - enterprise 3-22
 - industry standard 3-18
- mkdir command 1-11
- more command 6-20, 7-9
- mv command 1-32

N

- network administrator user accounts
 - application examples 9-7
- Network Management Station
 - see NMS
- Network Time Protocol
 - see NTP
- NI modules
 - behavior during takeover 5-31
- NMS 3-8
- NTP 4-1
 - application examples 4-3
 - configuring 4-9
 - client 4-9
 - defaults 4-2
 - overview 4-5
 - specifications 4-2
 - stratum 4-6
 - using in a network 4-6
- ntp broadcast command 4-9
- ntp broadcast-delay command 4-9
- NTP client
 - broadcast delay 4-9
 - broadcast mode 4-9
- ntp client command 4-3, 4-9
- NTP Configuration
 - verify information about 4-13
- ntp key command 4-12
- ntp key load command 4-12
- NTP server
 - designating 4-10

- minimum poll time 4-10
- preferred server 4-11
- Synchronization Tests 4-10
- version number 4-11
- ntp server command 4-3, 4-10

P

- partition management 3-14
- password command 9-13
- passwords
 - expiration 9-16
 - global settings 9-10
 - minimum length 9-15
 - user-configured 9-13
- pre_banner.txt file 2-23
- Prefix Recognition 6-13
 - application examples 6-14
- prefixes 6-13
- primary CMM
 - swapping with the secondary 5-29
 - synchronizing with secondary 5-27
- prompt 6-15, 6-19
- prompt prefix command 6-15
- pwd command 1-8

R

- RADIUS accounting servers
 - Authenticated Switch Access 10-12
- RADIUS servers
 - for switch security 10-4
- RAM 5-3
- rcp command 1-17
- reboot
 - cancelling 5-14, 5-20, 5-25
 - checking status 5-15
 - primary 5-13, 5-25
 - scheduling 5-14, 5-25
 - secondary 5-25
 - working directory 5-18, 5-26
- reload cancel command 5-14, 5-20
- reload command 5-14, 5-25
- reload secondary command 5-25
- reload working command 5-18
- rls command 1-17
- rmdir command 1-13
- rrm command 1-17
- running configuration 5-3, 5-4
 - copying to working directory 5-16
- rz command 1-27

S

- screen
 - display 6-19
 - prompt 6-15, 6-19
- secondary CMM
 - managing files 1-17
 - swapping with the primary 5-29

- synchronizing with primary 5-27
 - Secure Shell 2-6, 2-12, 10-9
 - algorithms 2-15
 - DSA key 10-11
 - key exchange 2-15
 - managing the switch 10-11
 - Secure Socket Layer
 - WebView 11-4
 - security
 - SNMP 3-10
 - Server Load Balancing
 - application examples 3-30
 - session banner command 2-22
 - session login-attempt command 2-24
 - session login-timeout command 2-24
 - session prompt command 6-19
 - session timeout command 2-24
 - sftp command 1-24, 2-20
 - sftp6 command 1-24, 1-35
 - SHA
 - authentication 3-11
 - show command-log command 6-18
 - show command-log status command 6-18
 - show configuration status command 7-3, 7-7
 - show history command 6-15
 - show ip helper command 7-3
 - show microcode command 5-24, 6-12
 - show ntp client command 4-4
 - show ntp client server-list command 4-3
 - show ntp server status command 4-3
 - show prefix command 6-14
 - show reload command 5-15
 - show running-directory command 5-23, 5-30
 - show snmp community map command 3-10
 - show snmp mib family command 3-17, 6-25
 - show snmp station command 3-4
 - show snmp trap replay command 3-15
 - show user command 3-5, 3-11, 9-7
 - snapshots 7-10, 7-14
 - SNMP
 - access for user accounts 9-24
 - agent 3-7
 - application examples 3-4
 - browser 2-7
 - defaults 3-3
 - management station 3-8
 - manager 3-7
 - security 3-10, 3-13
 - specifications 3-2
 - traps table B-2
 - versions 3-8
 - snmp community map mode command 9-23
 - SNMP configuration
 - verify information about 3-26
 - snmp security command 3-13, 9-23
 - snmp trap filter command 3-6
 - software rollback
 - configuration scenarios 5-5
 - specifications
 - CLI 6-2
 - CMM 5-2
 - configuration file 7-2
 - file management 1-2
 - login 2-3
 - NTP 4-2
 - SNMP 3-2
 - switch security 10-2
 - user database 3-27, 9-2
 - ssh command 2-18, 2-20
 - SSL
 - HTTPS port 11-4
 - see Secure Socket Layer
 - startup
 - defaults 9-6
 - switch
 - rebooting 5-13, 5-25
 - switch security
 - defaults 10-2
 - specifications 10-2
 - syntax 6-4
 - syntax checking 6-13
 - System Clock 1-41
 - system date command 1-41
 - system time command 1-42
 - system timezone command 1-41
- ## T
- tables
 - displays 6-20
 - filters 6-25
 - takeover** command 5-29
 - Telnet 2-6, 2-8
 - telnet** command 2-8
 - time 1-42, 7-4
 - time zone 1-41
 - timed sessions 7-4
 - cancelling 7-7
 - future timed session 7-5
 - Trap Filters
 - application examples 3-5
 - Traps 3-14
 - traps
 - authentication 3-15
 - families 3-14
 - filters 3-14
 - management 3-15
 - tty** command 6-19
- ## U
- user accounts
 - defaults 9-2
 - for switch access 9-4
 - saving settings 9-11
 - SNMP access 9-24
 - user command 3-5, 9-8, 9-16, 9-27, 10-7
 - creating a user 9-12
 - user configuration

- verify information about 9-27
- user database
 - specifications 3-27, 9-2
 - switch management 10-5
- user password-expiration command 9-16
- user password-size min command 9-15
- users
 - see user accounts
- UTC 4-1

V

- verbose mode 7-9
- vi command 1-14

W

- WebView 11-1
 - accessing WebView 11-8
 - adjacencies 11-23
 - application examples 11-5
 - browser setup 11-2
 - CLI commands 11-3
 - configuring the switch 11-8
 - defaults 11-2
 - disabling 11-3
 - enabling 11-3
 - HTTP port 11-3
 - on-line help 11-28
 - Secure Socket Layer 11-4
- Webview
 - Configuring the Switch 11-8
- who command 2-19, 6-22
- whoami command 6-23
- wildcards 6-25
- working directory 5-3
 - copying to certified directory 5-21, 5-26
- write memory command 5-17

Z

- Zmodem 1-26

